

## Temporary Maintenance Instruction TMI 139-475 (Rev.G)

### Engine LH/RH Reinforcement P/N 3P5333A15352 / 3P5333A15452 Replacement Procedure

#### All AW139 Helicopters

*The technical content of this document is approved under the authority of DOA nr. EASA.21J.005.*

*The present TMI will be evaluated for its introduction in the standard set of Technical Publication.*

*If no further notice is received, the present document expires on: **June 17<sup>th</sup> 2025.***

**2024-06-17**

## Introduction

This TMI provides the instructions and requirements to replace the AW139 Engine LH/RH reinforcement P/N 3P5333A15352 / 3P5333A15452.

Rev G of this TMI is published in order to extend its expiration date.

## Engine LH/RH Reinforcement P/N 3P5333A15352 / 3P5333A15452 Replacement Procedure

### Table of contents

- References
- Preliminary requirements
- Procedure
- Requirements after job completion
- Appendix A
- Appendix B

### List of tables

- 1 References
- 2 Access point
- 3 Zones
- 4 Required conditions
- 5 Support Equipment
- 6 Supplies
- 7 Spares

### List of figures

Figure 1.....	9
Figure 2.....	9
Figure 3.....	9
Figure 4.....	10
Figure 5.....	10
Figure 6.....	10
Figure 7.....	11
Figure 8.....	11
Figure 9.....	12
Figure 10.....	13
Figure 11.....	14
Figure 12.....	14
Figure 13.....	15
Figure 14.....	16
Figure 15.....	17
Figure 16.....	17
Figure 17.....	18
Figure 18.....	19
Figure 19.....	20
Figure 20.....	20
Figure 21.....	20
Figure 22.....	20
Figure 23.....	21
Figure 24.....	22
Figure 25.....	23
Figure 26.....	24
Figure 27 (RH SIDE ONLY).....	24
Figure 28.....	25

Figure 29 (LH SIDE ONLY) .....26  
 Figure 30..... 26  
 Figure 31..... 27

**References**

**Table 1 References**

Data Module	Title
1 - 39-A-00-20-00-00A-120A-A	Helicopter safety - Make the helicopter safe for maintenance
2 - 39-A-62-11-01-00A-520A-A	Main rotor blade - Remove procedure
3 - 39-A-62-22-00-00A-520A-A	Main rotor head - Remove procedure
4 - 39-A-63-20-00-00A-520A-A	Main gearbox group - Remove procedure
5 - 39-A-71-02-01-00A-520A-A	Number 1 engine - Remove procedure
6 - 39-A-71-02-02-00A-520A-A	Number 2 engine - Remove procedure
7 - 39-A-71-22-01-00A-520A-A	Number 1 engine bracket - Remove procedure
8 - 39-A-71-22-03-00A-520A-A	Number 2 engine bracket - Remove procedure
9 - 39-A-53-40-00-00A-520A-A	Tail section (structure) - Remove procedure
10 - 39-A-20-40-01-00A-66AA-A	Tubes – Repair procedure
11 - 39-A-53-40-00-00A-720A-A	Tail section (structure) - Install procedure
12 - 39-A-71-22-03-00A-720A-A	Number 2 engine bracket - Install procedure
13 - 39-A-71-22-01-00A-720A-A	Number 1 engine bracket - Install procedure
14 - 39-A-71-02-02-00A-720A-A	Number 2 engine - Install procedure
15 - 39-A-71-02-01-00A-720A-A	Number 1 engine - Install procedure
16 - 39-A-63-20-00-00A-720A-A	Main gearbox group - Install procedure
17 - 39-A-62-22-00-00A-720A-A	Main rotor head - Install procedure
18 - 39-A-62-11-01-00A-720A-A	Main rotor blade - Install procedure

## *Preliminary Requirements*

### Required conditions

**Table 3 Required conditions**

Conditions	Data
1 - The helicopter must be safe for maintenance	39-A-00-20-00-00A-120A-A
2 - The main rotor blades must be removed	39-A-62-11-01-00A-520A-A
3 - The main rotor head must be removed	39-A-62-22-00-00A-520A-A
4 - The main gear box group must be removed	39-A-63-20-00-00A-520A-A
5 - The number 1 engine must be removed	39-A-71-02-01-00A-520A-A
6 - The number 2 engine must be removed	39-A-71-02-02-00A-520A-A
7 - The number 1 engine outboard bracket must be removed	39-A-71-22-01-00A-520A-A
8 - The number 2 engine outboard bracket must be removed	39-A-71-22-03-00A-520A-A
9 - The tail section (structure) must be removed	39-A-53-40-00-00A-520A-A

### Support equipment

**Table 3 Support Equipment**

Nomenclature	Identification No.	Qty
1 - Scope assy holder engine mock-up	P/N 3G6310H00111A651A	1
2 - Engine optical sight adapter	P/N 3G6310H00111A651A	1
3 - Alignment telescope outside dia 57.14	P/N TEC06-147	1
4 - Intermediate target dia 57.14	P/N TEC 06-148	1
5 - Data processing software: AW139_MGB_ENG_INSTL_V.10	T1396300S1A686A	1
6 - Crosshead/Trm special bolt	4G6310H00851A651A <sup>(1)</sup>	1
7 - Positioning tool	Local supply	1

Note (1): To be used with accessory drive kit 4G6320F00211

## Supplies

**Table 4 Supplies**

Nomenclature	Identification No.	Qty
1 - RIVET	MS20615-4M4	AR
2 - RIVET	MS20615-5M5R	AR
3 - RIVET	MS20615-5M7R	AR
4 - RIVET	MS20470-AD5-8	AR
5 - RIVET	MS20470-AD5-9-5	AR
6 - RIVET	MS20470-AD5-10	AR
7 - RIVET	MS20470-AD4-6	AR
8 - RIVET	MS20470-AD5-9	AR
9 - RIVET	MS20615-4M3	AR
10 - RIVET	MS20615-4M3R	AR
11 - RIVET	MS20615-4M4R	AR
12 - RIVET	MS20615-4M5R	AR
13 - RIVET	MS20427M4-4	AR
14 - SEALANT	MC 780 Type I, Class C (C465)	AR
15 - SEALANT	Proseal 700 Type I (C032)	AR
16 - SEALANT	CS-1900 Type I (C032)	AR
17 – Solvent	Aliphatic naphtha (C059)	AR

Note: For hardware related to repair, check the relevant applicable repair document.

## Spares

**Table 5 Spares**

Nomenclature	Identification No.	Qty
1 - Engine left reinforcement	P/N 3P5333A15352	1
2 - Engine right reinforcement	P/N 3P5333A15452	1

Note: Engine reinforcement productive P/N 3P5333A15352M01 / 3P5333A15452M01 or 3P5333A15352M02 / 3P5333A15452M02 can be provided as alternative to the technical P/N 3P53333A15352 / 3P53333A15452.

## Safety conditions

### WARNINGS

The materials that follow are dangerous. Before you do this procedure, make sure that you know all the safety precautions and first aid instructions for these materials:

- Solvent (Supplies Ref. 17)
- Sealant (Supplies Ref. 14, Supplies Ref. 15, Supplies Ref. 16).

### Procedure

### NOTES

- A. Place an identification tag on all the re-usable components, including the attaching hardware that has been removed to gain access to the modification area and adequately protect them until their later re-use.
- B. Shape the cables in order to prevent interference with the structure and the other existing installations, using where necessary suitable lacing cords.
- C. During drilling operations pay extreme attention in order to prevent instruments, cables and hosing damage. After drilling, clean the area and remove sharp edges. Apply on bare metal a light film of primer unless the hole is used for ground connection.
- D. Before installing new rivets check for holes condition; if holes condition is not suitable use oversize rivets. If necessary install rivets with different grips.
- E. Perform cold working on Aluminium Alloy structure holes for fasteners type "Hi-Lok".
- F. All riveting and de-riveting in accordance with the IETP ASRP.
- G. All Hi-Lok fasteners installed and removed in accordance with IETP ASRP.
- H. Use aliphatic naphtha to degrease. Cleaned surfaces shall be allowed to air dry for at least 30 minutes before bonding.
- I. Let adhesive cure at room temperature for at least 24 hours unless otherwise specified.
- J. All dimensions are in mm.
- K. During the application of the subsequent procedure, in order to receive additional information to get access to the work area, if needed, contact the Manufacturer.

### Note:

The steps below are referred to the right side

1. Get access to the area.
2. Remove part of the firewall located at STA 6460 by de-riveting (ref. Figure 6).

3. Remove thermal blanket and fire wire loom as required.
4. Remove the hardware that connects the engine support to the structure.
5. With reference to Figure 1, cut upper deck skin, water deflector and outboard curved skin according to repair schemes in Appendix B.
6. Remove nuts connecting drain forward and rearward scuppers with skin.
7. Remove rivets connecting upper deck skin and outboard curved skin to the structure in order to have access to the engine reinforcement support.
8. With reference to Figure 2, cut drain line 65mm aft of rear scupper tube and tee section and remove.
9. With reference to Figure 3, remove rivets as required to loosen structure and mount.
10. With reference to Figure 4, remove bracket holding the drain line.
11. With reference to Figure 5, remove triangular gusset frame (it is possible to maintain the lateral L-profile attached) underneath outboard curved skin by de-riveting. Figure 6 and Figure 8 show disassembled and removed parts.
12. With reference to Figure 9, remove profile running afterwards at BL 675.
13. With reference to Figure 7, manufacture a Positioning tool (Ref. Support Equipment 7) to copy the original position of the mount within the airframe.
14. Remove the right engine reinforcement.
15. Temporarily install the new P/N 3P5333A15452 (Ref. Spares 2).
16. Using the positioning tool, report on the new component the holes.
17. Remove the new reinforcement.
18. Clean and deburr holes. Also clear the work area of any contaminants.
19. With reference to Figure 9 to Figure 12, partially install the right engine reinforcement P/N 3P5333A15452 at STA 6388.
20. Position drain line, repair according to AMP DM 39-A-20-40-01-00A-66AA-A.
21. With reference to figures from Figure 13 to Figure 18, install the triangular gusset frame and the attached angular at STA 6388.
22. With reference to figures from Figure 13 to Figure 18, install the bracket P/N 3P5315A01051.
23. With reference to figures from Figure 19 to Figure 22, install the pipe assy P/N 3G7170A11031.
24. With reference to figures from Figure 19 to Figure 22,, install the pipe assy P/N 3G7170A14632.
25. With reference to figures from Figure 9 to Figure 12 and repair schemes in Appendix B, install profile running afterwards at BL 675.
26. With reference to figures from Figure 9 to Figure 12 and repair schemes in Appendix B, complete installation of the right engine reinforcement P/N 3P5333A15452 at STA 6388.



27. Repair upper deck skin, water deflector and outboard curved skin according to repair schemes in Appendix B.
28. Repeat the procedure from step 1 to 27 for the left engine reinforcement P/N 3P5333A15352.
29. With reference to figures from Figure 23 to Figure 30, install the firewall removed at step 2.
30. In applying AMP DM 39-A-71-22-01-00A-720A-A / DM 39-A-71-22-03-00A-720A-A to install the engine fittings, proceed as follows:
  - 30.1 With reference to Figure 10 and Figure 31, apply MC 780 Type I, Class C sealant (Ref. Supplies 14) by interposition between:
    - 30.1.1 Engine reinforcement and cover P/N 3P5333A14351;
    - 30.1.2 Cover and shim P/N 3P5333A14251;
    - 30.1.3 Shims and engine fittings.\
  - 30.2 With reference to Figure 31, cover the bolts heads with Proseal 700 Type I (Ref. Supplies 15) or CS-1900 Type I sealant (Ref. Supplies 16).

### ***Requirement after job completion***

1. Perform the Alignment check procedure as described in Annex A
2. Return the helicopter to flight configuration.

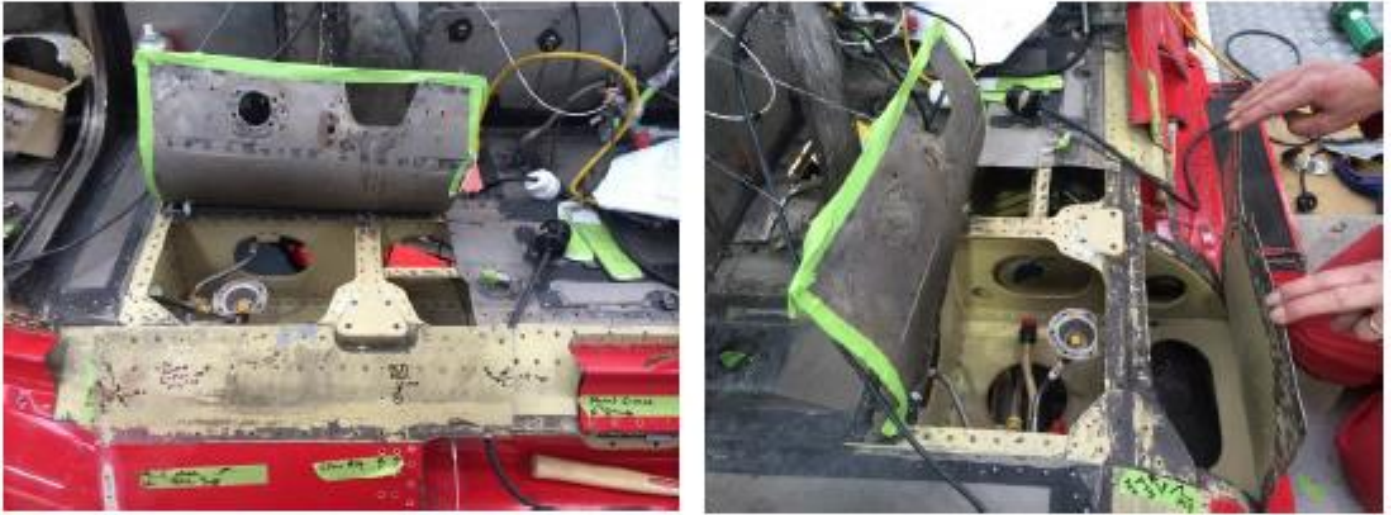

Figure 1

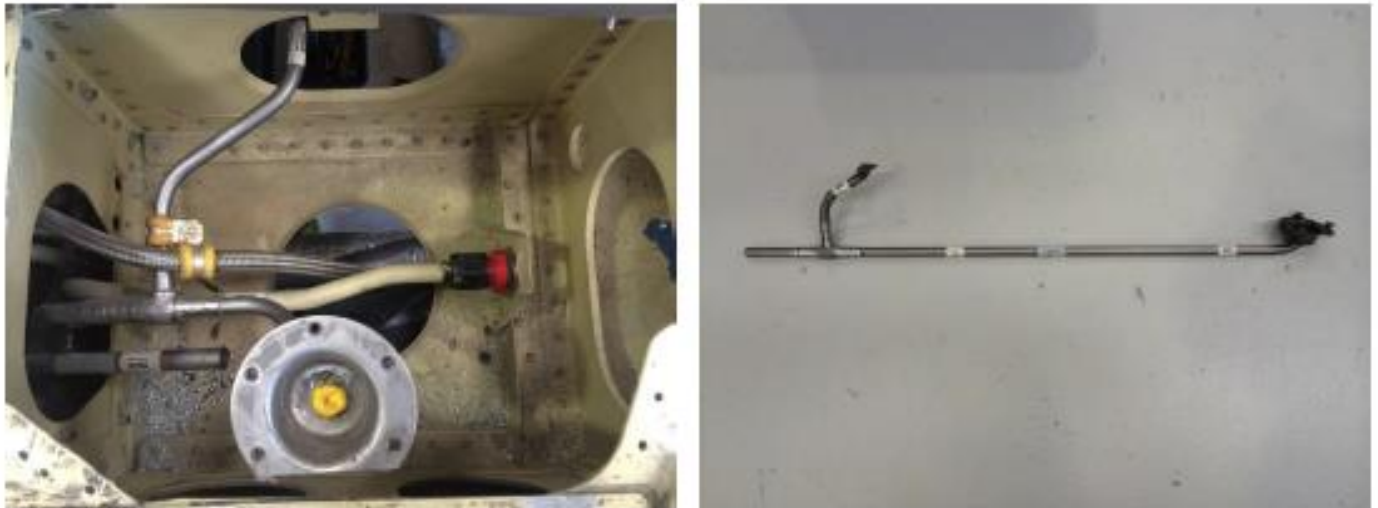

Figure 2

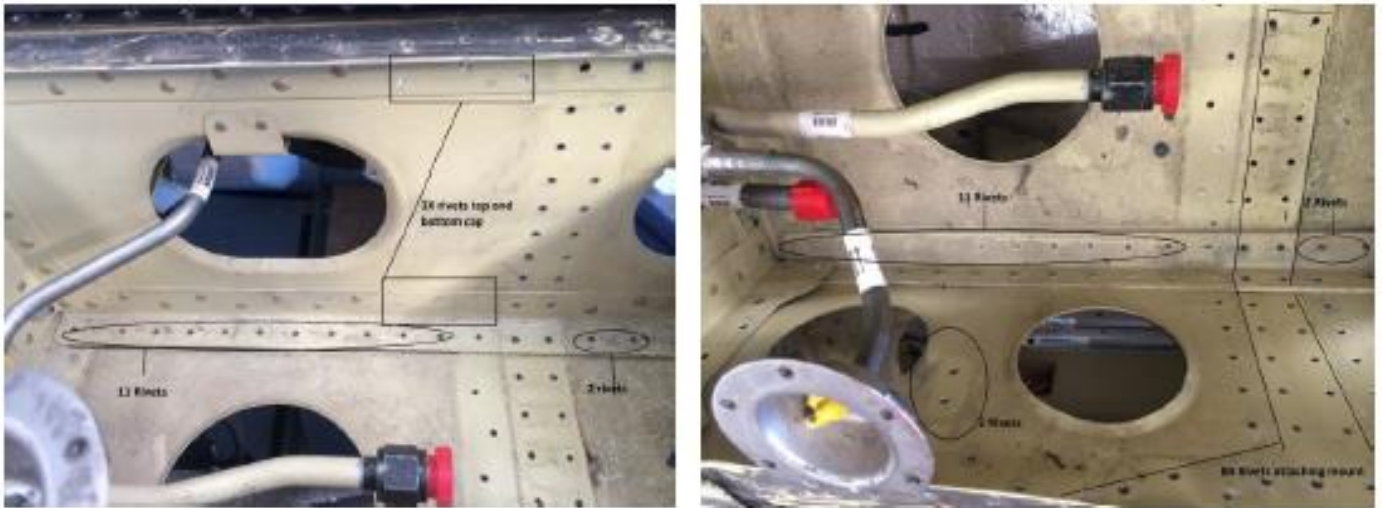

Figure 3



Figure 4



Figure 5



Figure 6

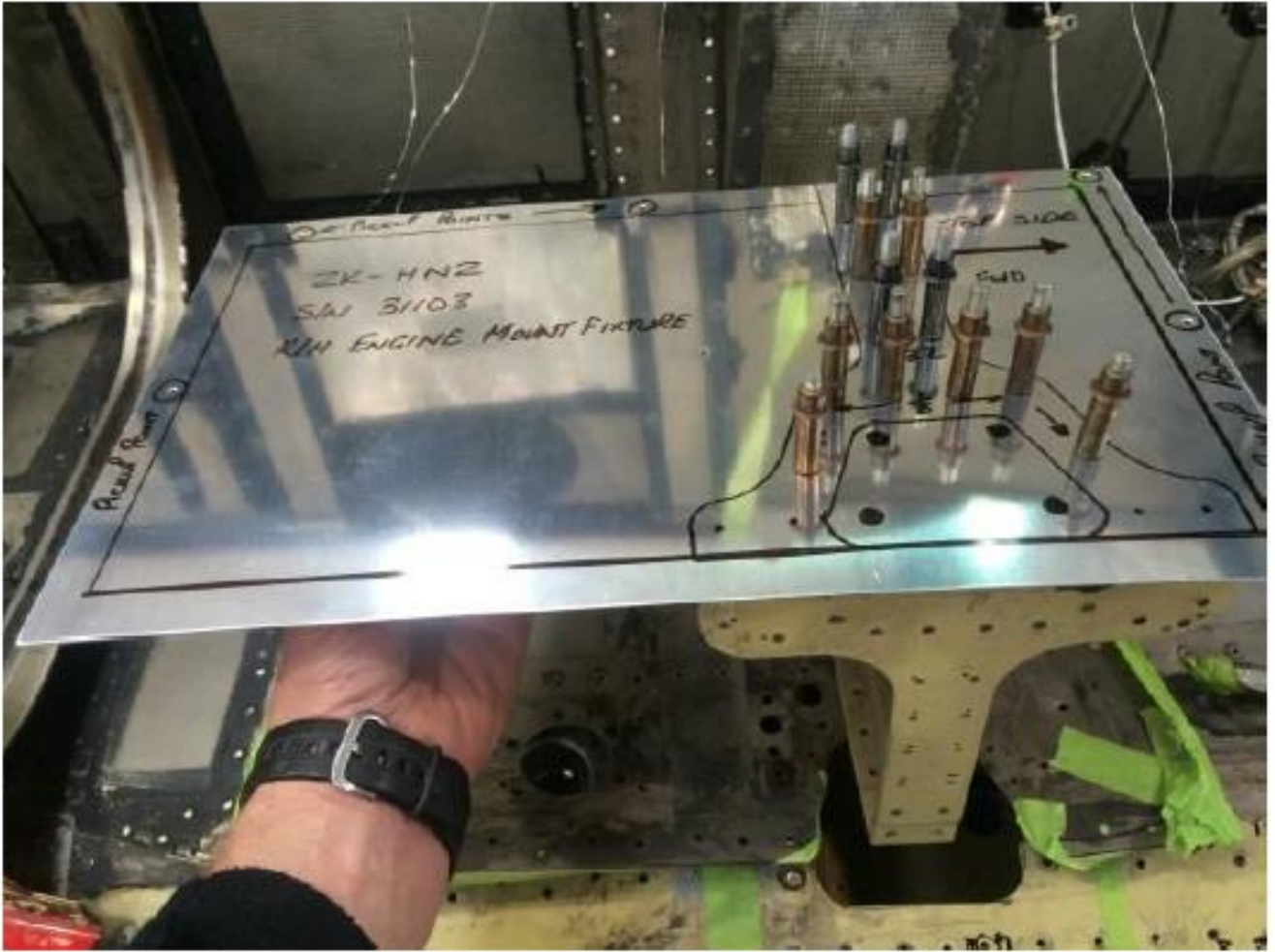

Figure 7



Figure 8

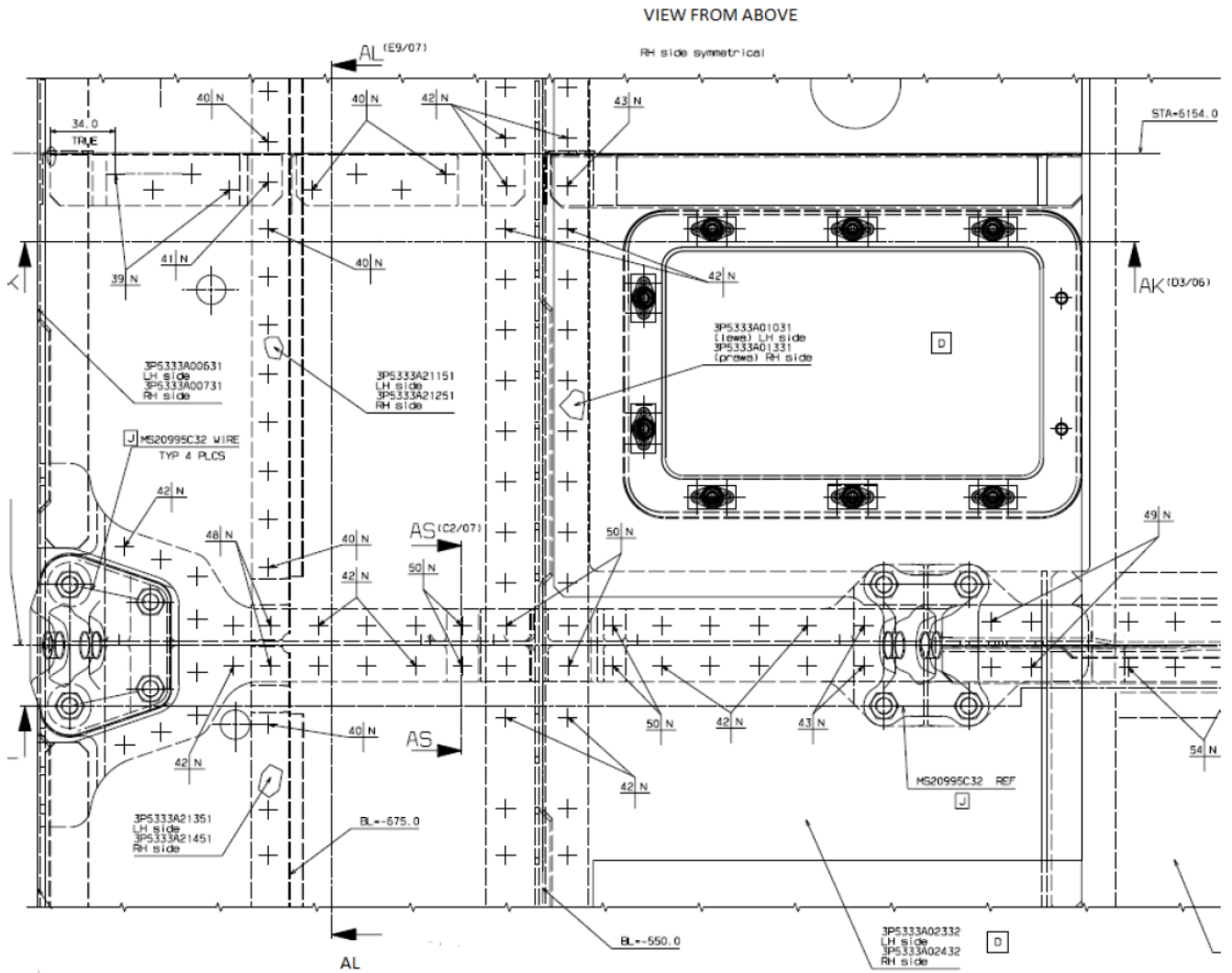

Figure 9



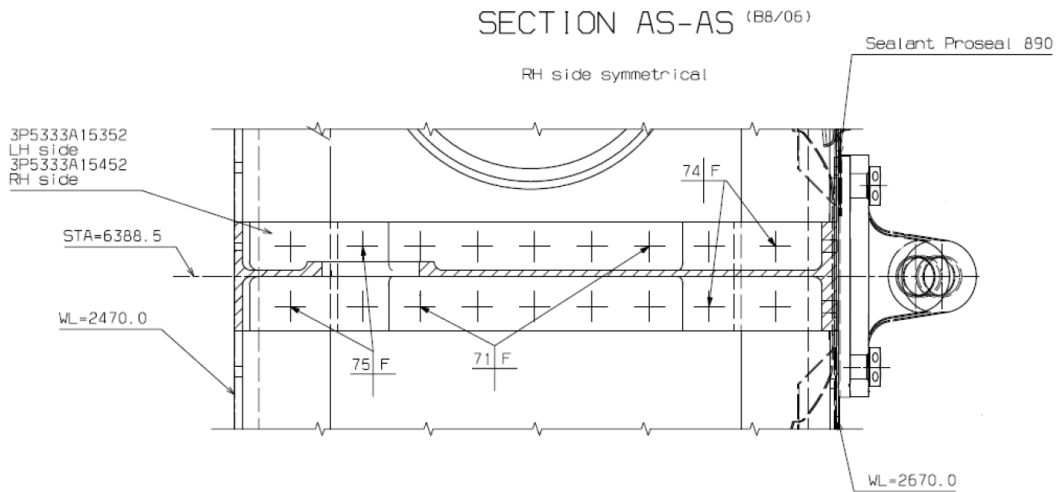

Figure 11

Rivets list for Figures from Figure 9 to Figure 11

REF. No	RIVET PART NUMBER	REF. No	RIVET PART NUMBER
35	MS20426 AD5-8	63	
36	MS20426 AD5-8-5	64	MS20470 AD5-4-5
37		65	MS20470 AD5-5
38		66	MS20470 AD5-5-5
39	MS20615-4M3R	67	MS20470 AD5-6
40	MS20615-4M4	68	MS20470 AD5-6-5
41	MS20615-4M4R	69	MS20470 AD5-7
42	MS20615-4M5	70	MS20470 AD5-7-5
43	MS20615-4M5R	71	MS20470 AD5-8
44		72	MS20470 AD5-8-5
45		73	MS20470 AD5-9
46		74	MS20470 AD5-9-5
47		75	MS20470 AD5-10
48	MS20615-5M6R	76	
49	MS20615-5M7	77	
50	MS20615-5M7R	78	
51		79	
52		80	AS46789-512
53	MS20470 AD4-4	81	
54	MS20470 AD4-4-5	82	
55	MS20470 AD4-5	83	MS20470 E4-6
56	MS20470 AD4-5-5	84	
57	MS20470 AD4-6	85	
58	MS20470 AD4-6-5	86	MS20470 E5-5-5
59		87	MS20470 E5-7
60		88	MS20470 E5-7-5
61		89	MS20470 E5-9
62		90	

RIVET CODE IN ACCORDANCE WITH NTA018R			
REF. NUMBER		ORIENTATION	
COUNTERSINK			BLANK
NOTE: EDGE DISTANCE FROM CENTRAL LINE EXCEPT WHERE INDICATED OTHERWISE NON-COMPOSITE UNIVERSAL HEAD 2 TIMES SHANK DIA. COUNTERSINK HEAD 2.5 TIMES SHANK DIA. COMPOSITE UNIVERSAL HEAD 2.5 TIMES SHANK DIA. COUNTERSINK HEAD 3 TIMES SHANK DIA.			
REF. No	RIVET PART NUMBER	REF. No	RIVET PART NUMBER
01		18	MS20426 AD4-5-5
02		19	
03		20	
04	MS20426 AD3-3-5	21	
05	MS20426 AD3-4	22	
06	MS20426 AD3-4-5	23	
07	MS20426 AD3-5	24	
08	MS20426 AD3-5-5	25	
09	MS20426 AD3-6	26	
10		27	
11	MS20426 AD3-7	28	
12		29	
13		30	
14		31	MS20426 AD5-6
15		32	MS20426 AD5-6-5
16		33	MS20426 AD5-7
17	MS20426 AD4-5	34	MS20426 AD5-7-5

Figure 12



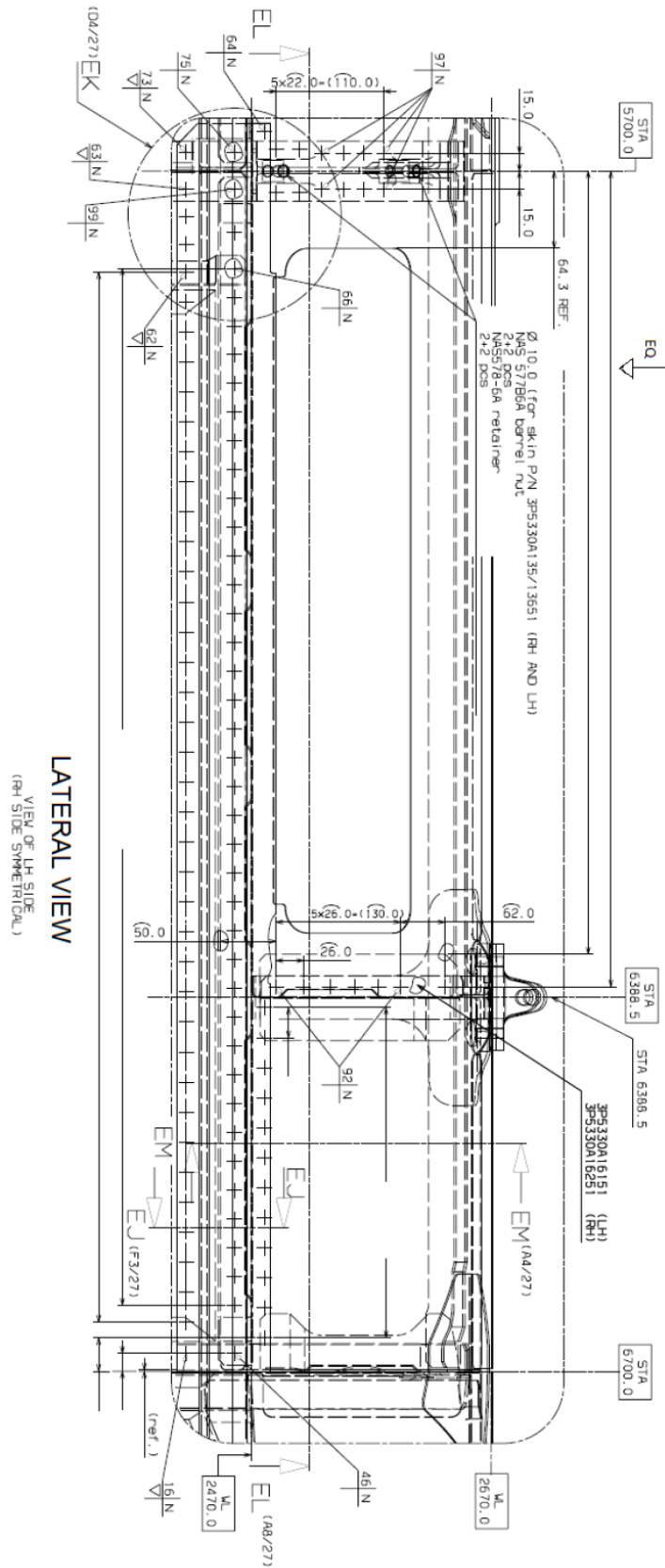

Figure 13

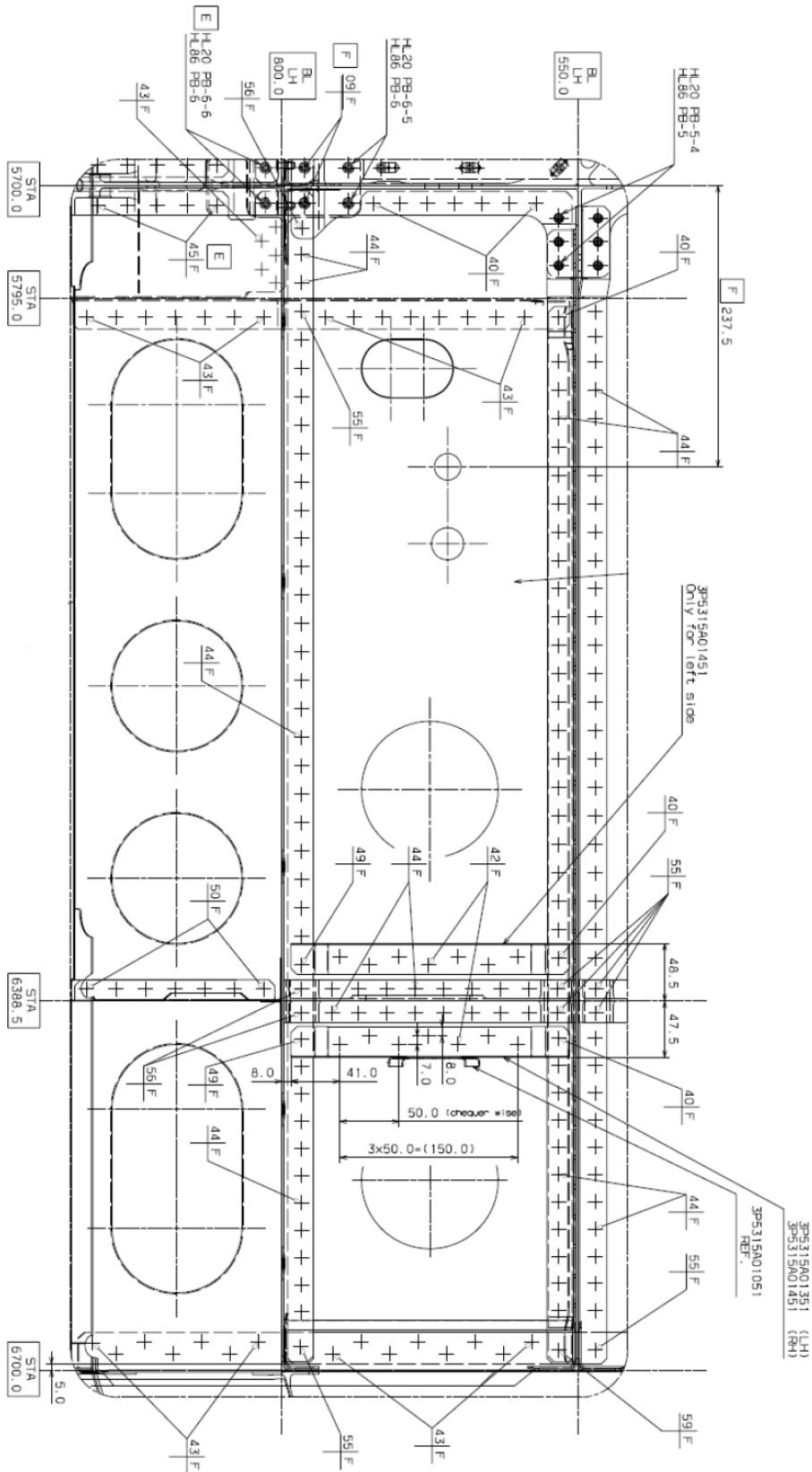

Figure 14

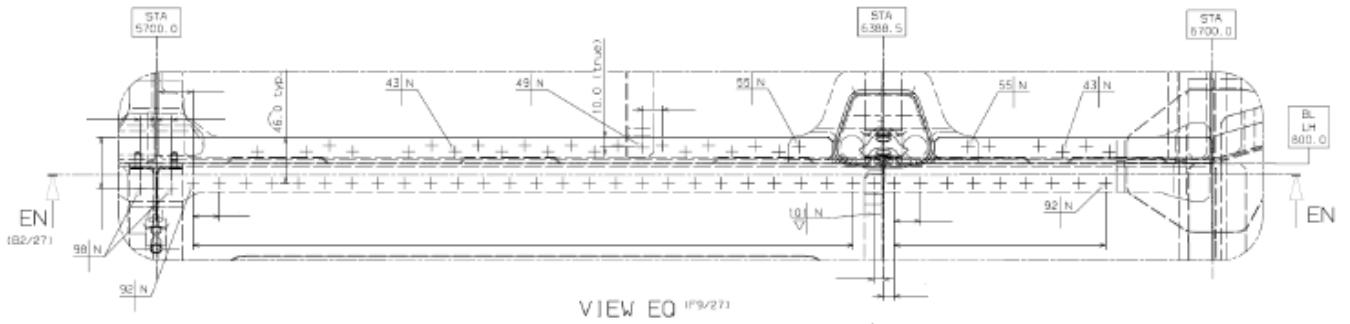

Figure 15

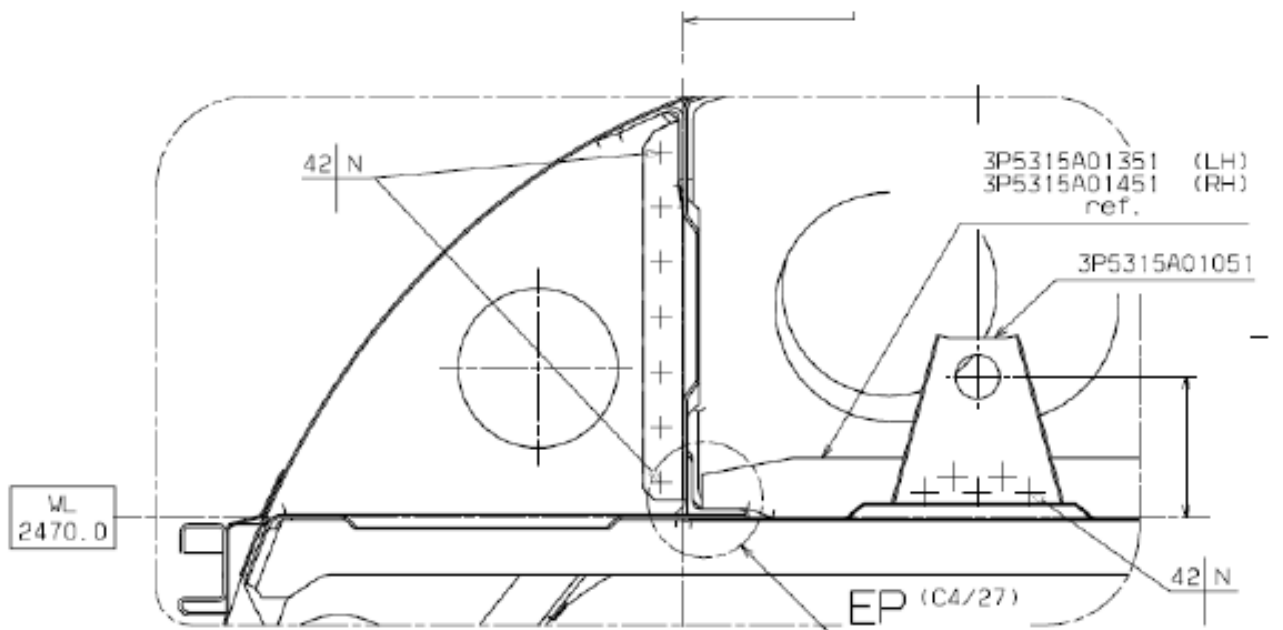

Figure 16

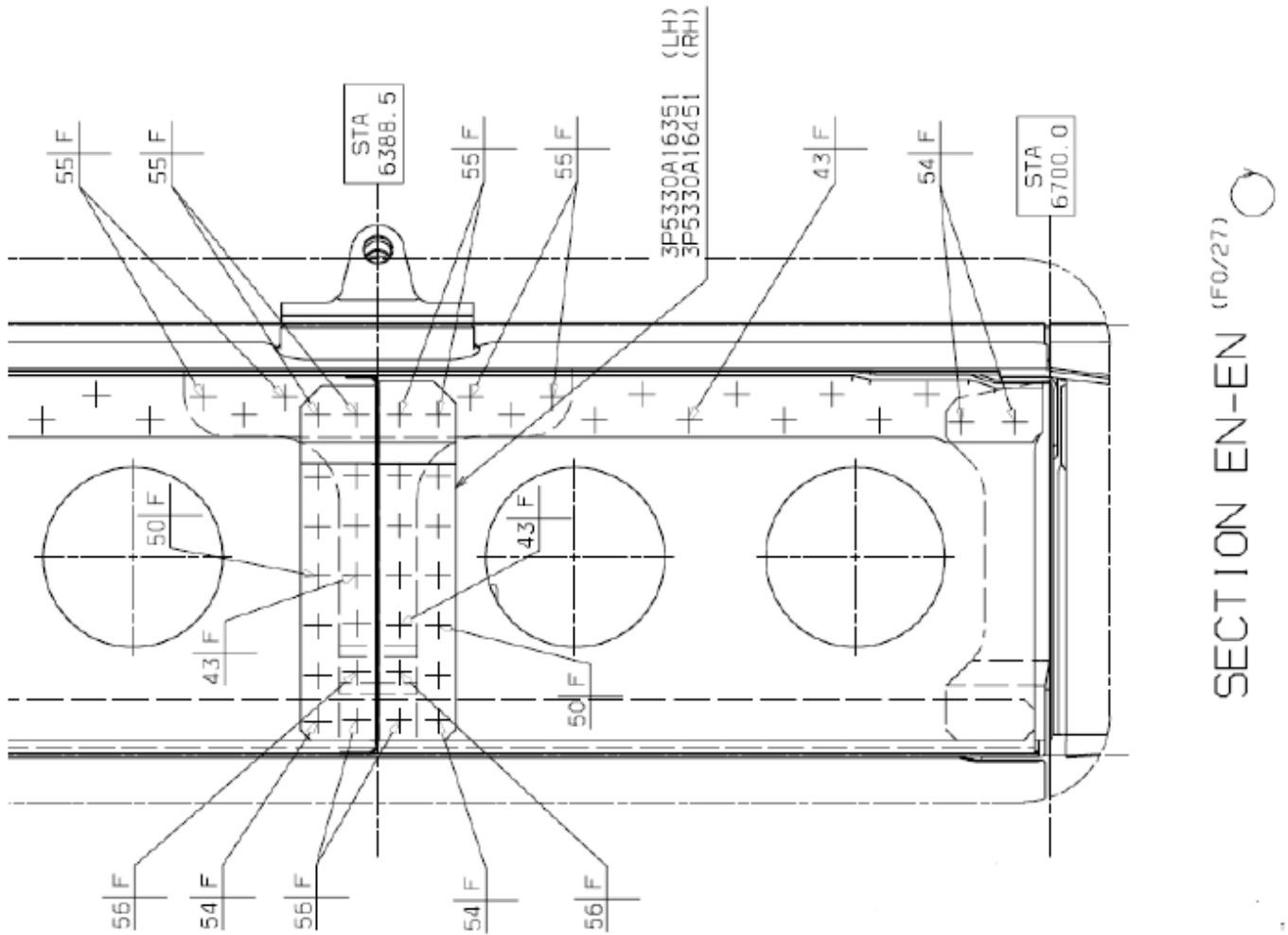

Figure 17

Rivets list for Figures from Figure 13 to Figure 1:

REF. No	RIVET PART NUMBER	REF. No	RIVET PART NUMBER
01	MS20426 AD3-2	56	MS20470 AD5-9
02	MS20426 AD3-3	57	MS20470 AD5-10
03	MS20426 AD3-4	58	MS20470 AD5-6-5
04	MS20426 AD3-5	59	MS20470 AD5-7-5
05	MS20426 AD3-6	60	MS20470 AD5-11
06	MS20426 AD3-5-5	61	AG54720-407
07	MS20426 AD3-7-5	62	AG54720-409
08	MS9035450605	63	AG54720-411
09	MS9035450608	64	AG54719-407
10	MS20426 AD4-4-5	65	MS20615-4M5
11	MS20426 AD4-3	66	AG54719-409
12	MS20426 AD4-4	67	AS46789-407
13	MS20426 AD4-5	68	AS46789-409
14	MS20426 AD4-6	69	AS46789-411
15	MS20426 AD4-7	70	AS46789-512
16	MS20426 AD4-8	71	AS46791-407
17	MS20426 AD4-5-5	72	AS46791-409
18	MS20426 AD4-6-5	73	AS46791-411
19	MS20426 AD4-9	74	AS46791-413
20		75	AS46789-514
21	MS20426 AD5-4	76	MS20427M4-4
22	MS20426 AD5-5	77	MS20427M4-4-5
23	MS20426 AD5-6	78	MS20427M4-5
24	MS20426 AD5-7	79	MS20427M4-5-5
25	MS20426 AD5-8	80	MS20427M4-6
26	MS20426 AD5-9	81	MS20427M4-7
27	MS20426 AD5-10	82	MS20615-5M6R
28		83	MS20615-5M7
29		84	MS20615-5M7R
30		85	NAS1097AD4-5
31	MS20470 AD3-3	86	NAS1097AD4-5-5
32	MS20470 AD3-4	87	NAS1097AD4-7
33	MS20470 AD3-5	88	NAS1097AD5-5
34	MS20470 AD3-6	89	NAS1097AD5-8
35	MS20470 AD3-7	90	NAS1097U4-5
36		91	NAS1097U4-7
37		92	M7885/2-4-02
38		93	M7885/2-4-03
39	MS20470 AD4-7-5	94	M7885/2-4-04
40	MS20470 AD4-6-5	95	AS46789-413
41	MS20470 AD4-3	96	MS20615-4M8
42	MS20470 AD4-4	97	M7885/2-5-03
43	MS20470 AD4-5	98	M7885/2-5-04
44	MS20470 AD4-6	99	M7885/2-5-05
45	MS20470 AD4-7	100	
46	MS20470 AD4-8	101	M7885/3-4-02
47	MS20470 AD4-9	102	M7885/3-4-03
48	MS20470 AD4-10	103	M7885/3-4-04
49	MS20470 AD4-5-5	104	
50	MS20470 AD4-4-5	105	
51	MS20470 AD5-4	106	M7885/3-5-03
52	MS20470 AD5-5	107	M7885/3-5-04
53	MS20470 AD5-6	108	M7885/3-5-05
54	MS20470 AD5-7	109	M7885/3-5-06
55	MS20470 AD5-8	110	AS46789-415

Figure 18

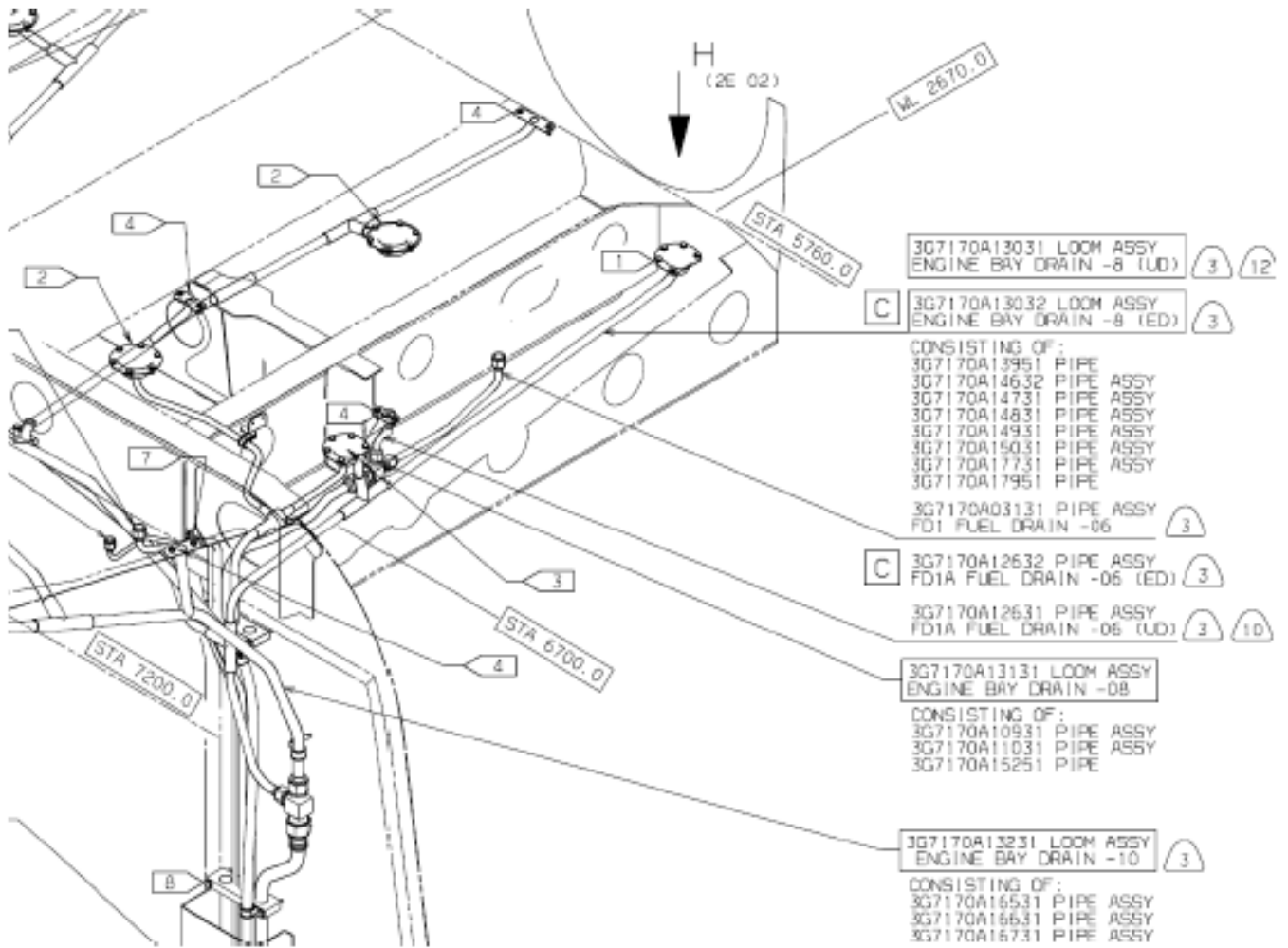

Figure 19

C	4	5	3	MS27039C0806	BOLT	QTY 5
				NAS1802-3-6	BOLT	ALT
				NAS1149CN832R	WASHER	QTY 5

Figure 20

C	4	5	1	NAS1802-08-6	BOLT	QTY 2
				MS27039C0806	BOLT	QTY 3
				NAS1802-3-6	BOLT	ALT
				NAS1149CN832R	WASHER	QTY 5

Figure 21

C	B	4	5	4	MS27039C0808	BOLT	QTY 2
					NAS1802-3-8	BOLT	ALT
					NAS1149CN832R	WASHER	QTY 2

Figure 22

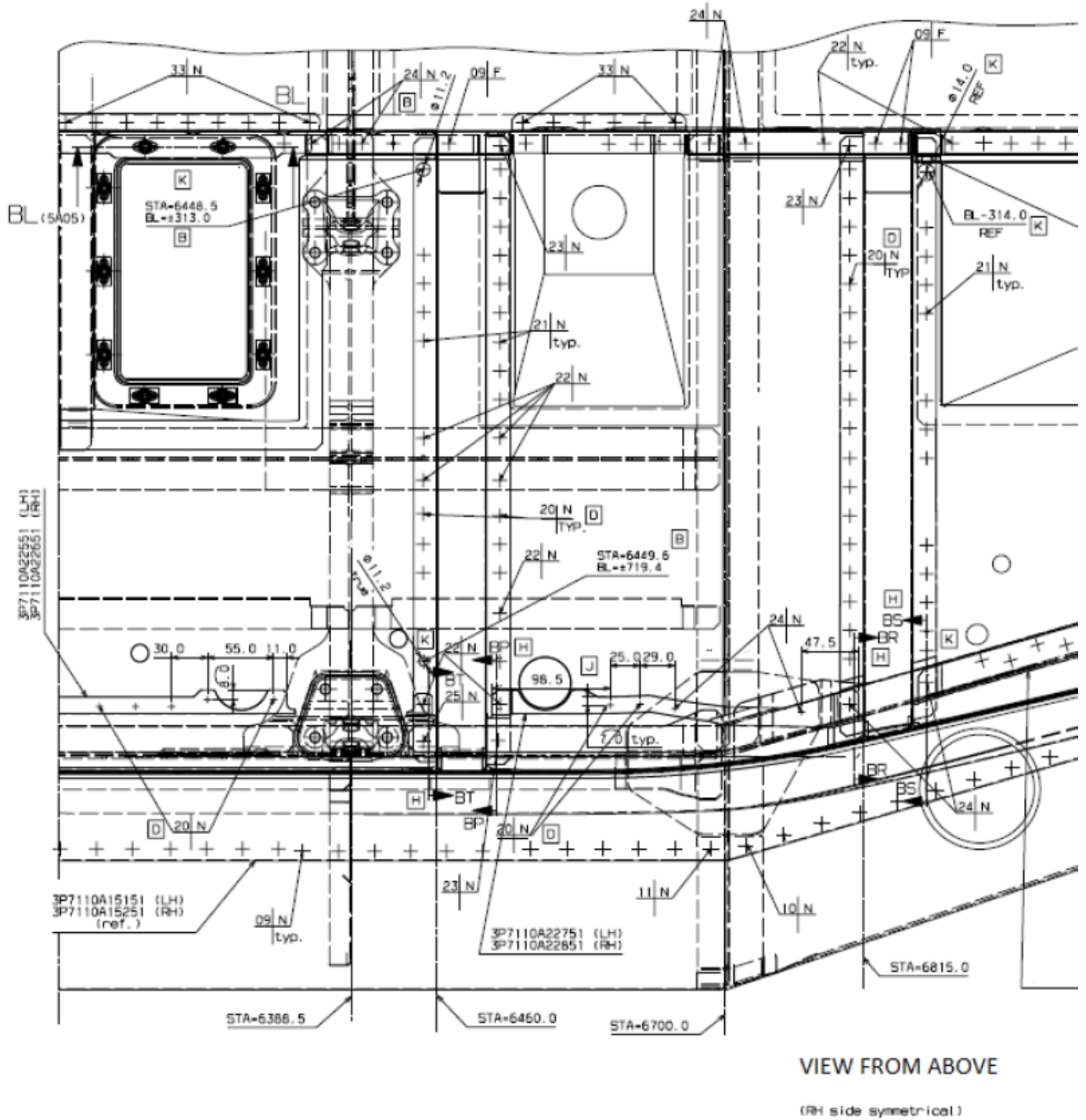

Figure 23

## Rivets list for Figure 23

TABELA NITOW WG NTA018R RIVET CODE IN ACCORDANCE WITH NTA018R				NR KOL/ REF.No	NORMA NITA/ RIVET PART NUMBER	NR KOL/ REF.No	NORMA NITA/ RIVET PART NUMBER
NR KOLEJNY/ REF. NUMBER	POLOZENIE LBA/ ORIENTATION	NIT WPUSZCZANY/ COUNTERSINK	RUSTE POLE/ BLANK	15	MS20427M3-3 <input type="checkbox"/> D	33	MS20470AD4-4-5
				16	MS20427M4-3-5	34	MS20470AD4-5
				17		35	MS20470AD4-5-5
				18	MS20427M4-4-5	36	MS20470AD4-6
				19	MS20427M4-5	37	
				20	MS20615-4M3 <input type="checkbox"/> D	38	NAS9307MP4-02 <input type="checkbox"/> B
				21	MS20615-4M3R	39	
				22	MS20615-4M4	40	M7885/2-4-03
				23	MS20615-4M4R	41	
				24	MS20615-4M5	42	
				25	MS20615-4M5R	43	
NR KOL/ REF.No	NORMA NITA/ RIVET PART NUMBER	NR KOL/ REF.No	NORMA NITA/ RIVET PART NUMBER	26	MS20426AD4-3-5	44	M7885/2-5-04
1	AGS 4719-405	8	AS 46789-405	27	MS20426AD4-4	45	
2	AGS 4719-407	9	AS 46789-407	28	MS20426AD4-4-5	46	M7885/2-5-06
3	AGS 4719-409	10	AS 46789-409	29	MS20426AD4-5	47	
4	AGS 4719-411	11	AS 46789-512	30	MS20426AD4-5-5	48	MS20615-3M4R <input type="checkbox"/> E
5	A298A04TW02	12	AS 46791-407	31	MS20470AD4-3-5	49	MS20615-4M6R
6	AGS 4720-407	13	AS 46791-409	32		50	
7		14					

Figure 24



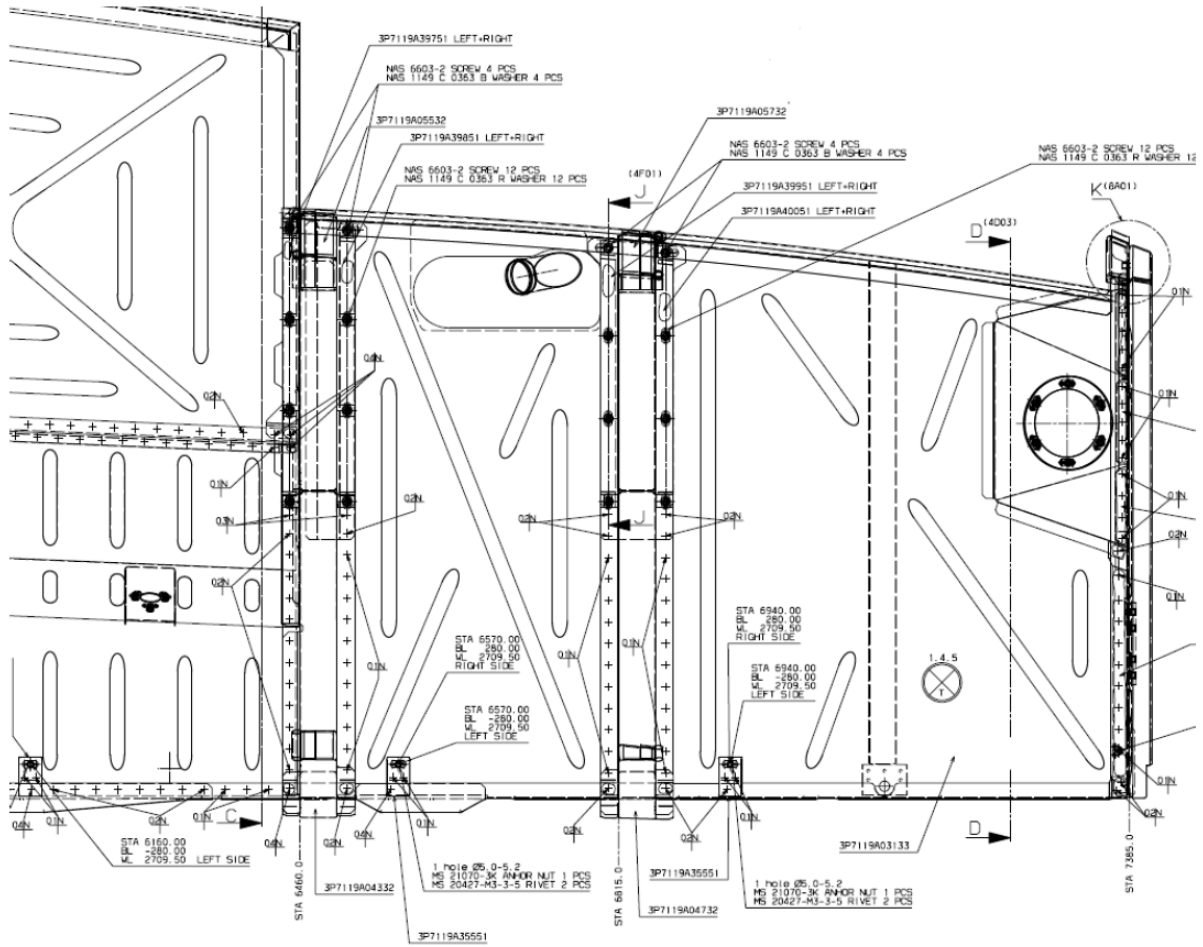

Figure 25

Rivets list for Figure 25

RIVET CODE IN ACCORDANCE WITH NTA018R CODICE RIVETTO SECONDO NTA018R			
REF. NUMBER NUMERO DI RIFERIMENTO		ORIENTATION ORIENTAMENTO	
COUNTERSINK TIPO DI SVASATURA		BLANK LASCIARE LIBERO	
<b>NOTE:</b> EDGE DISTANCE FROM CENTRELINE EXCEPT WHERE INDICATED OTHERWISE  <b>NON-COMPOSITE</b> UNIVERSAL HEAD 2 TIMES SHANK DIA. COUNTERSINK HEAD 2.5 TIMES SHANK DIA.  <b>COMPOSITE</b> UNIVERSAL HEAD 2.5 TIMES SHANK DIA. COUNTERSINK HEAD 3 TIMES SHANK DIA.		<b>NOTA:</b> DISTANZA DEL BORDO DALL'ASSE ECETTO COME INDICATO  <b>NON-COMPOSITO</b> TESTA UNIVERSALE 2 VOLTE IL DIAMETRO DEL GAMBO. TESTA SVASATA 2 VOLTE IL DIAMETRO DEL GAMBO.  <b>COMPOSITO</b> TESTA UNIVERSALE 2,5 VOLTE IL DIAMETRO DEL GAMBO. TESTA SVASATA 3 VOLTE IL DIAMETRO DEL GAMBO.	
REF. No No RIF.	RIVET PART NUMBER NUMERO PEZZO RIVETTO	REF. No No RIF.	RIVET PART NUMBER NUMERO PEZZO RIVETTO
1	MS20615-4M3		
2	MS20615-4M3R		
3	MS20427M4-4		
4	MS20615-4M4		
5	MS20615-4M5		
6	MS20615-4M4R		

Figure 26

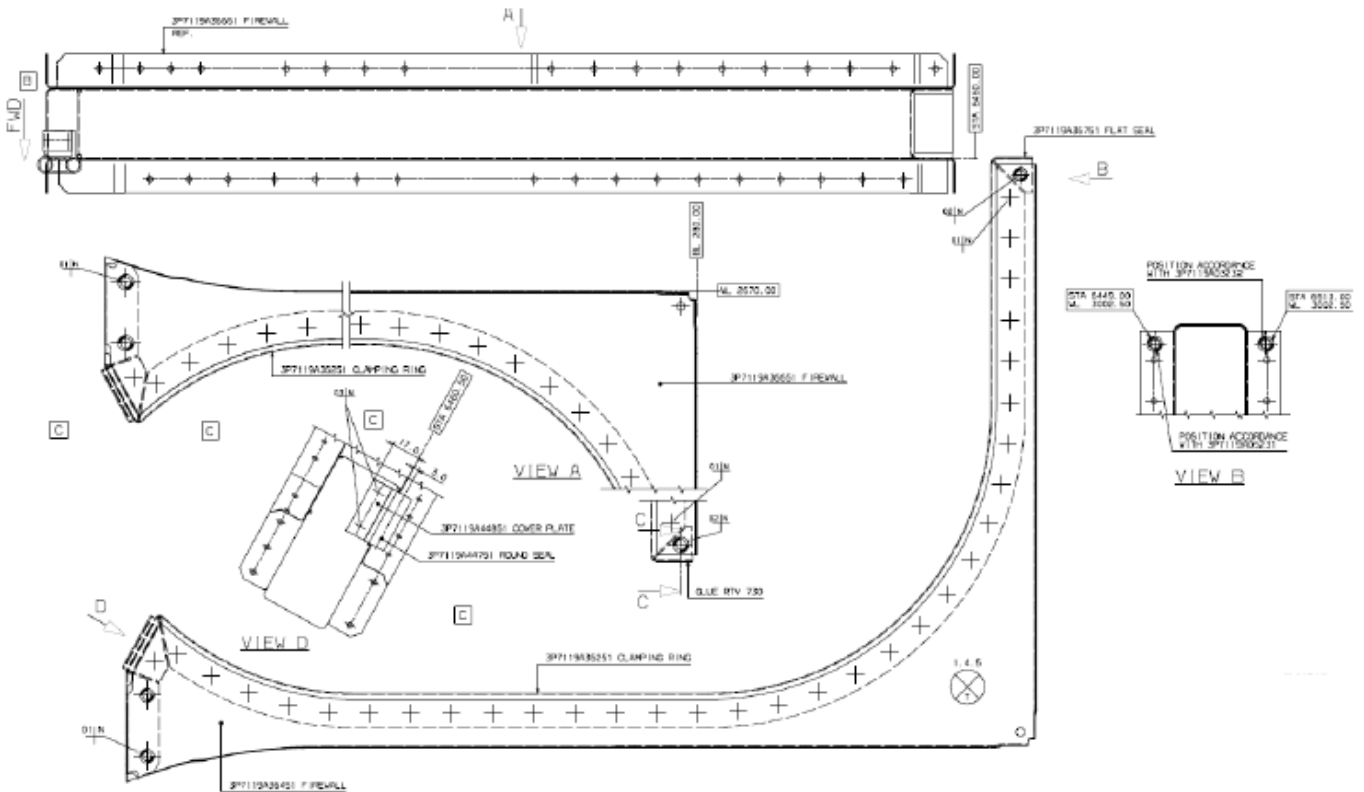

Figure 27 (RH SIDE ONLY)



**Rivets list for Figure 29**

RIVET CODE IN ACCORDANCE WITH NTA018R CODICE RIVETTO SECONDO NTA018R			
REF. NUMBER NUMERO DI RIFERIMENTO		ORIENTATION ORIENTAMENTO	
COUNTERSINK TIPO DI SVASATURA		BLANK LASCiare LIBERO	
<b>NOTE:</b> EDGE DISTANCE FROM CENTRELINE EXCEPT WHERE INDICATED OTHERWISE  <b>NON-COMPOSITE</b> UNIVERSAL HEAD 2 TIMES SHANK DIA. COUNTERSINK HEAD 2.5 TIMES SHANK DIA.  <b>COMPOSITE</b> UNIVERSAL HEAD 2.5 TIMES SHANK DIA. COUNTERSINK HEAD 3 TIMES SHANK DIA.		<b>NOTA:</b> DISTANZA DEL BORDO DALL'ASSE ECETTO COME INDICATO  <b>NON-COMPOSITO</b> TESTA UNIVERSALE 2 VOLTE IL DIAMETRO DEL GAMBO. TESTA SVASATA 2 VOLTE IL DIAMETRO DEL GAMBO.  <b>COMPOSITO</b> TESTA UNIVERSALE 2.5 VOLTE IL DIAMETRO DEL GAMBO. TESTA SVASATA 3 VOLTE IL DIAMETRO DEL GAMBO.	
REF.No No RIF.	RIVET PART NUMBER NUMERO PEZZO RIVETTO	REF.No No RIF.	RIVET PART NUMBER NUMERO PEZZO RIVETTO
01	MS20615-4M3		
02	MS20427M4-4		
03	AS46791-407		

Figure 30

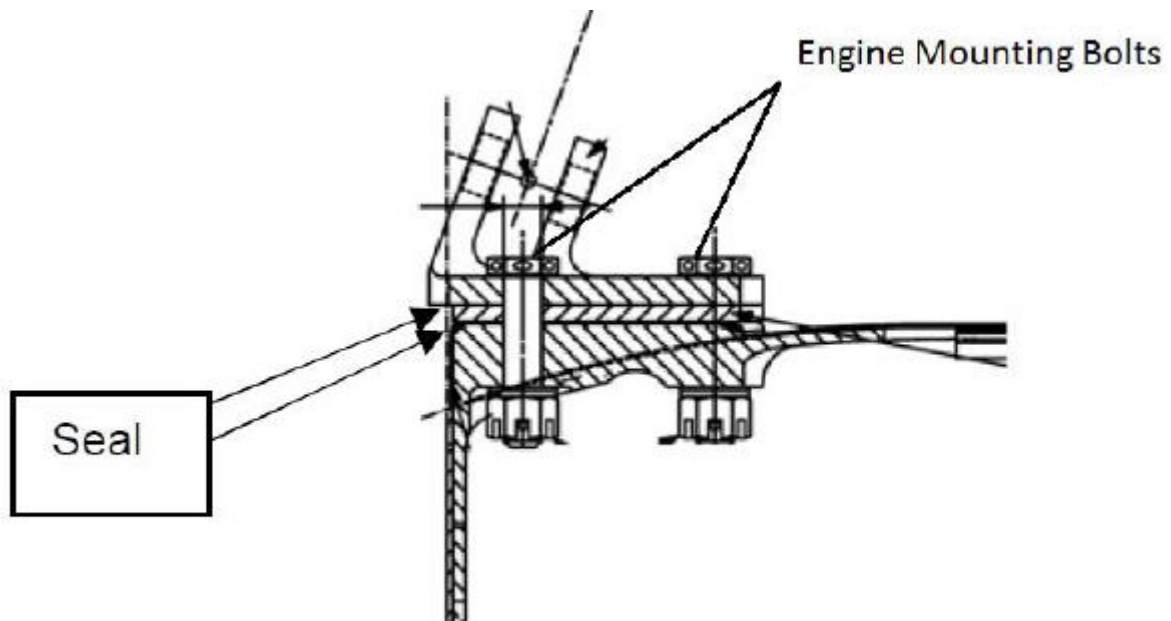

Figure 31

**Annex A**  
**Alignment Check**

**LEGENDA SIMBOLI UTILIZZATI - UTILIZED SYMBOLS LEGEND**

SIMBOLO SYMBOL	DESCRIZIONE DESCRIPTION	SIMBOLO SYMBOL	DESCRIZIONE DESCRIPTION
	INSERIRE FLAG SE OK, OPPURE AD OPERAZIONE ESEGUITA ENTER FLAG IF OK, OR UPON OPERATION COMPLETION		SERRARE SENZA CONTROLLO DI COPPIA TIGHTEN WITHOUT TORQUE VALUE
	ATTENZIONE WARNING		ALLENTARE LOOSEN
	FORWARD		RIMUOVERE REMOVE
	NOTA NOTE		INSTALLARE INSTALL
	REGISTRARE RECORD		
	MISURARE MEASURE		

RIF. FIG.	DESCRIPTION	P/N	S/N	NOTE
A	SCOPE ASSY HOLDER ENGINE MOCK-UP	3G6310H00111A651A		DETECT ENGINE MOCK-UP S/N
B	ENGINE OPTICAL SIGHT ADAPTER			DETECT ENGINE OPTICAL SIGHT ADAPTER S/N
C	ALIGNMENT TELESCOPE OUTSIDE DIA 57.14	TEC06-147		
D	INTERMEDIATE TARGET DIA 57.14	TEC06-148		
E	DATA PROCESSING SOFTWARE; AW139_MGB_ENG_INSTL_V.10	T1396300S1A686A		
F	CROSSHEAD/TRM SPECIAL BOLT	4G6310H00851A651A		TO BE USED WITH ACCESSORY DRIVE KIT 4G6320F00211

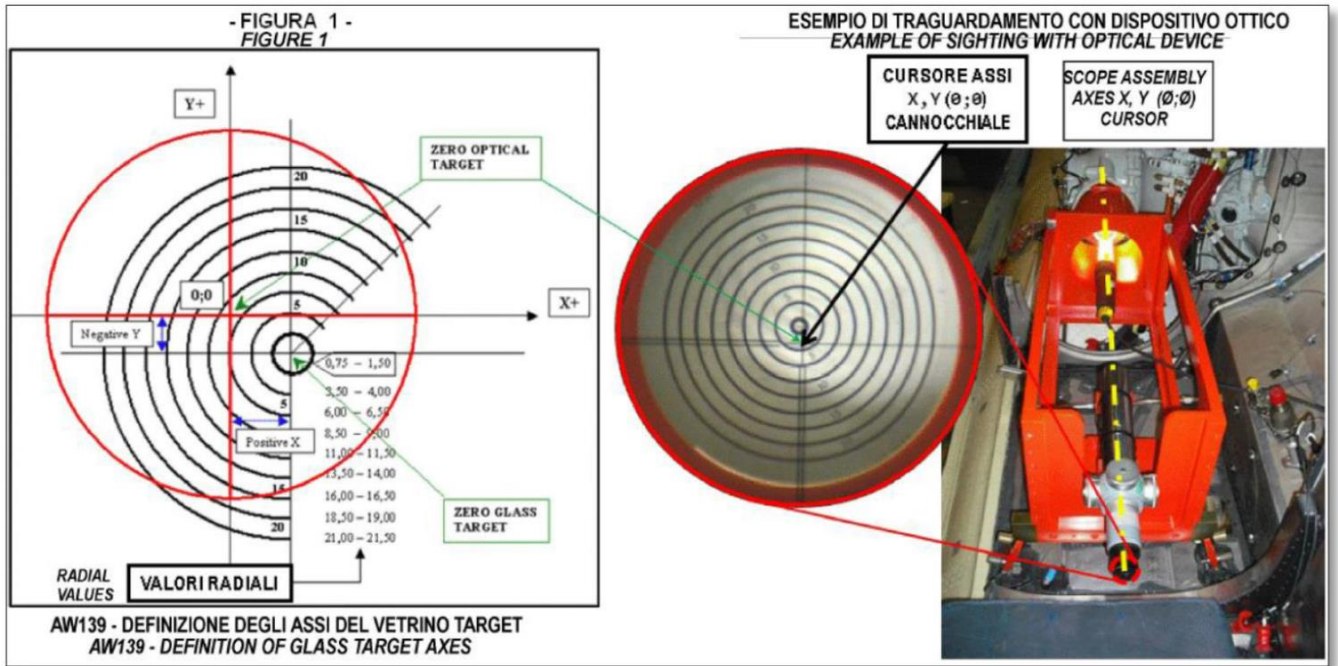

<div style="text-align: right; border: 1px solid black; padding: 2px;">RIF. 5.2</div> <p><b>X:</b> LATERAL AXIS (CORRESPONDING TO HELICOPTER BL)</p> <p><b>Y:</b> VERTICAL AXIS (CORRESPONDING TO HELICOPTER WL)</p> <p><b>Z:</b> LONGITUDINAL AXIS (CORRESPONDING TO HELICOPTER STA)</p> <p style="font-size: small;">LOCAL COORDINATES SYSTEM IS THE X,Y,Z COORDINATES SYSTEM USED IN CASE OF OPTICAL SIGHT UNIT UTILIZATION IN ORDER TO CHECK THE ALIGNMENT</p>	<p style="text-align: center;"><b>APPLICABLE DOCUMENTS:</b></p> <ul style="list-style-type: none"> <li>▪ <b>139G6300D002</b> ATP FOR MGB / ENGINE ALIGNMENT AND TAIL ROTOR DRIVE LINE FINAL ALIGNMENT</li> <li>▪ <b>3G6310V00152 (REF.)</b> INPUT SHAFT</li> <li>▪ <b>3G7100A00212 (REF.)</b> RIGHT ENGINE INSTL.</li> <li>▪ <b>3G6310A00212 (REF.)</b> SHAFT GIMBAL INSTL. RH</li> <li>▪ <b>3G6330A00111 (REF.)</b> MAIN TRASMISSION MOUNTINGS INSTL.</li> <li>▪ <b>139G6300D004 (REF.)</b> ACCEPTANCE TEST PROCEDURE FOR CABIN AND TAIL ALIGNMENTS</li> </ul>	<div style="text-align: right; border: 1px solid black; padding: 2px;">RIF. 5.1</div> <div style="text-align: center; margin-top: 20px;"> </div> <div style="border: 1px solid black; padding: 5px; font-size: small; margin-top: 5px;"> <p>THE HELICOPTER SHALL BE POSITIONED ON LANDING GEARS OR ON JACKS. THE MGB SHALL BE INSTALLED ON THE HELICOPTER AND SECURED IN ITS NOMNAL POSITION.</p> </div>
--	---	--



AW139 – ATP FOR MGB/ENGINE ALIGNMENT – RIF. 6.2 – 6.2.1 – 6.2.2

**ZONA DI LAVORO**  
**WORK AREA**

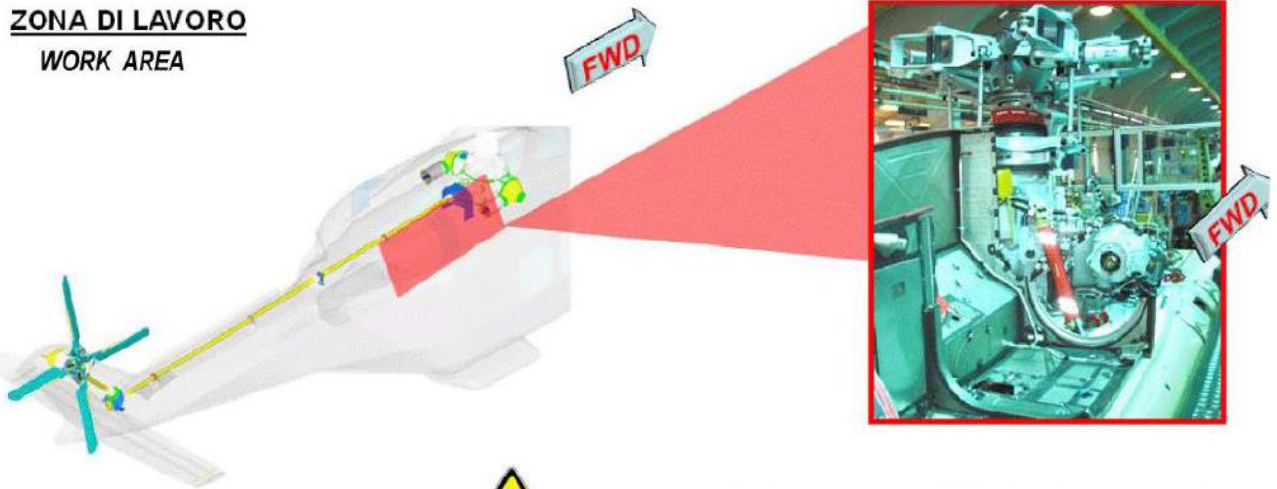

LE IMMAGINI MOSTRATE NELLE SUCCESSIVE OPERAZIONI SONO RELATIVE AL LATO SX. → LATO DX TIPICO E OPPOSTO.  
PICTURES SHOWN IN FOLLOWING OPERATIONS ARE RELEVANT TO LH SIDE → RH SIDE TYPICAL AND OPPOSITE

RIF. 6.2.1.T1 OK

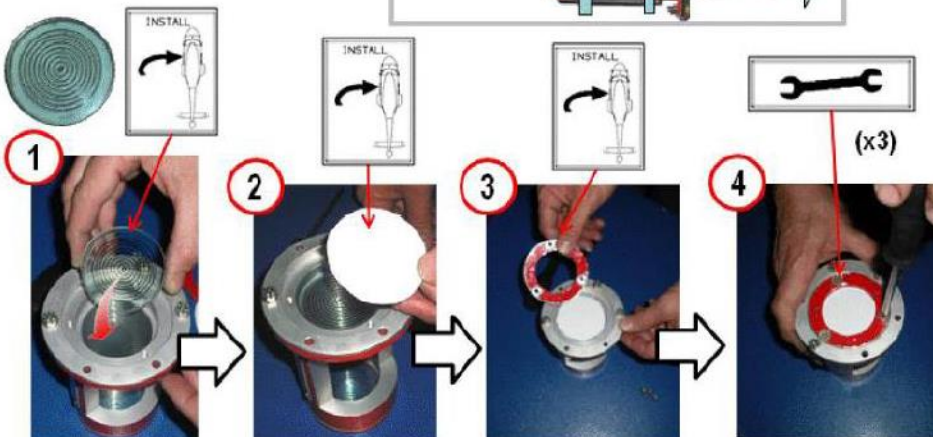
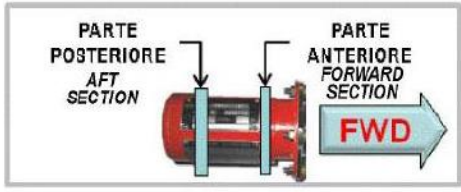





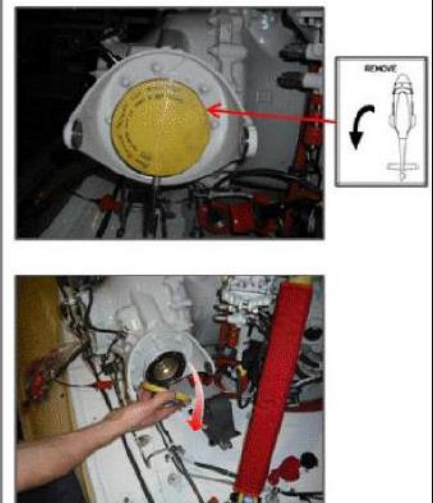

INSTALLARE SULL'ADATTATORE TRAGUARDO OTTICOMOTORE P/N 3G6310H00111A651A IL TARGET P/N TECO6-148 NELLA PARTE ANTERIORE  
INSTALL ON ENGINE OPTICAL SIGHT ADAPTER P/N 3G6310H00111A651A TARGET P/N TECO6-148 IN FORWARD SECTION





RIF. T1 OK

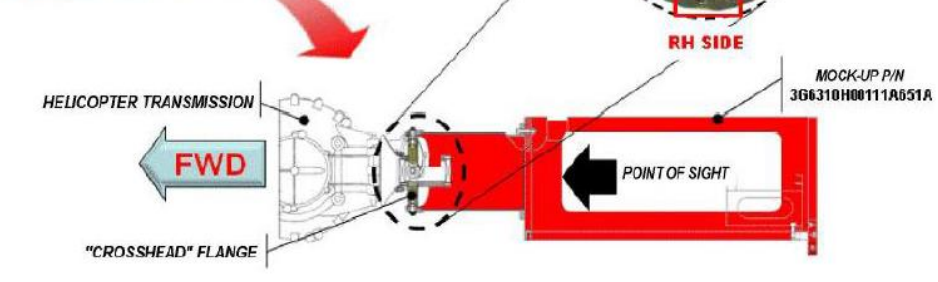

RIMUOVERE LA PROTEZIONE SULLA FLANGIA DX DELLA TRASMISSIONE PRIMA DI INSTALLARE I TOOL.  
REMOVE COVER ON TRANSMISSION RH FLANGE BEFORE INSTALLING THE TOOLS

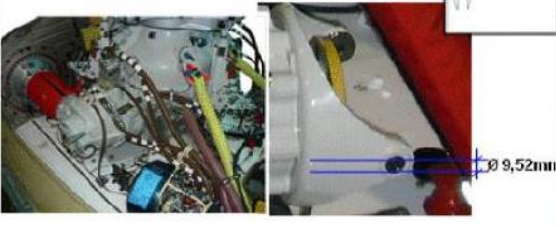
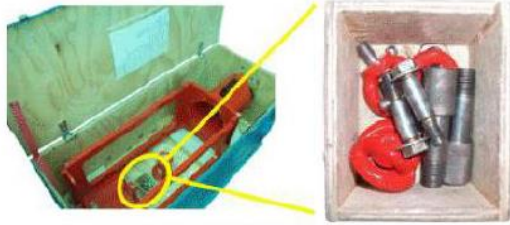

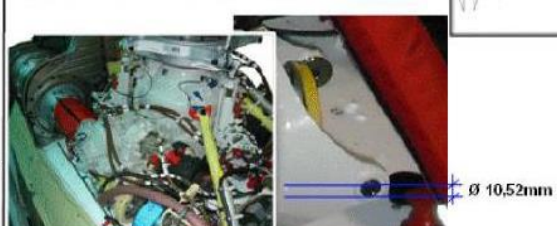
<table border="1" style="width: 100%; border-collapse: collapse;"> <tr> <td style="width: 10%; text-align: center;">RIF.</td> <td style="width: 60%;">6.2.1.T2</td> <td style="width: 10%; text-align: center;">OK</td> <td style="width: 10%;"></td> </tr> </table> <div style="margin-top: 5px;"> <p><b>1</b></p>  <div style="float: right; border: 1px solid black; padding: 2px; text-align: center;">INSTALL </div> </div> <div style="margin-top: 5px;"> <p><b>2</b></p>  <div style="float: right; text-align: center;">(x5) </div> </div> <div style="margin-top: 5px;"> <p><b>3</b></p>  </div> <div style="margin-top: 5px; font-size: small;"> <p><b>INSTALL ENGINE OPTICAL SIGHT ADAPTER P/N 3G6310H00111A651A ON LH TRANSMISSION FLANGE (BL 575.5)</b></p> </div>	RIF.	6.2.1.T2	OK		<table border="1" style="width: 100%; border-collapse: collapse;"> <tr> <td style="width: 10%; text-align: center;">RIF.</td> <td style="width: 60%;">T2</td> <td style="width: 10%; text-align: center;">OK</td> <td style="width: 10%;"></td> </tr> </table> <div style="margin-top: 5px;">  <div style="float: right; text-align: center;">VIEW FROM MOCK-UP INBOARD <b>UP</b> </div> </div> <div style="margin-top: 10px;">  <p style="text-align: right; font-size: small;">MOCK-UP P/N 3G6310H00111A651A</p> </div> <div style="margin-top: 10px; font-size: small;"> <p>FOR P/N 3G6310H00111A651A MOCK-UP INSTALLATION, MAKE SURE THAT "CROSSHEAD" CONNECTION FLANGE IS PROPERLY POSITIONED. CHECK THAT "RH SIDE" WORDING (FOR RH ENGINE) IS VISIBLE FROM MOCK-UP INNER SIDE (SEE POINT OF SIGHT). WORDING "OUTBOARD" WITH RELEVANT ARROW SHALL BE ALWAYS TURNED TOWARDS THE HELICOPTER EXTERNAL SIDE. OTHERWISE ROTATE THE FLANGE TO ENSURE PROPER POSITIONING.</p> </div>	RIF.	T2	OK	
RIF.	6.2.1.T2	OK							
RIF.	T2	OK							

<table border="1" style="width: 100%; border-collapse: collapse;"> <tr> <td style="width: 10%; text-align: center;">RIF.</td> <td style="width: 60%;">T3</td> <td style="width: 10%; text-align: center;">OK</td> <td style="width: 10%;"></td> </tr> </table> <p style="text-align: center; font-weight: bold;">ZONA DI LAVORO WORK AREA</p>  <p style="font-size: small;">VERIFICARE IN QUALE CONDIZIONE CI SI TROVA CHECK WHAT IS THE ACTUAL CONDITION</p>	RIF.	T3	OK		<p><b>CONDIZIONE A) INSTALLAZIONE STANDARD</b> A) CONDITION STANDARD INSTALLATION</p>  <div style="text-align: center; margin-top: 10px;">  <div style="border: 1px solid black; padding: 5px; width: fit-content; margin: 0 auto;"> <p>3G6310H00111A651A.503 Ø 9,5 mm TOT Length Lunghezza TOT 44,0 mm</p>  </div> </div>	<p><b>CONDIZIONE B) INSTALLAZIONE CON ACCESSORY DRIVE</b> B) CONDITION INSTALLATION WITH ACCESSORY DRIVE</p>  <div style="text-align: center; margin-top: 10px;">  <div style="border: 1px solid black; padding: 5px; width: fit-content; margin: 0 auto;"> <p>4G6310H00851A651A Ø 10,5    Ø 9,5 mm        mm TOT Length Lunghezza TOT 44,0 mm</p>  </div> </div>
RIF.	T3	OK				

**ENTER FLAG IN BOX CORRESPONDING TO THE "INSTALLATION" TYPE**

**A) CONDITION**  
**STANDARD MGB/CROSSHEAD INSTALLATION**  
**(WITHOUT ACCESSORY DRIVE KIT)**



**BOLTS TO BE USED TO LINK ENGINE MOCK-UP TO STANDARD MGB**

**BOLTS INCLUDED IN KIT FOR ENGINES ALIGNMENT 3G6310H00111A651A**

**B) CONDITION**  
**MGB+ACCESSORY DRIVE/CROSSHEAD**  
**INSTALLATION**



**BOLTS TO BE USED TO LINK ENGINE MOCK-UP TO MGB + ACCESSORY DRIVE, IDENTIFIED BY FOLLOWING PRODUCTION P/INs:**

- 4G6320F00212A3
- 4G6320F00212A4



**SPECIFY WHICH MGB IS INSTALLED**

**NOTIFY ANY DIFFERENT P/INs**

	R.F. <b>6.2.1.T3</b>	OK			
	<p><b>UTILIZZARE I BULLONI DEFINITI NELLE OPERAZIONI PRECEDENTI</b>  <b>USE BOLTS DEFINED IN PREVIOUS OPERATIONS</b></p>				
<p>POSIZIONARE IL SIMULACRO P/IN 3G6310H00111A651A IN PROSSIMITA' DELLA FLANGIA DX DELLA TRASMISSIONE (BL 575.5) (1), ALLINEARE I FORI DEL CROSSHEAD CON I FORI DELLA FLANGIA (2), ALLINEARE I DUE ATTACCHI POSTERIORI (3) E FISSARLI ENTRAMBI (4). INFINE SERRARE IL SIMULACRO ALLA FLANGIA DELLA PRESA DI MOTORE ELICOTTERO MOTORE DX (5).          POSITION P/IN 3G6310H00111A651A MOCK-UP CLOSE TO TRANSMISSION RH FLANGE (BL 575.5) (1), ALIGN CROSSHEAD HOLES WITH FLANGE HOLES (2), ALIGN THE TWO AFT FITTINGS (3) AND SECURE BOTH (4). FINALLY SECURE THE MOCK-UP TO HELICOPTER RH ENGINE DRIVE QUILL FLANGE (5).</p>					

RIF.	<b>6.2.1.T4</b>	OK	
------	-----------------	----	--

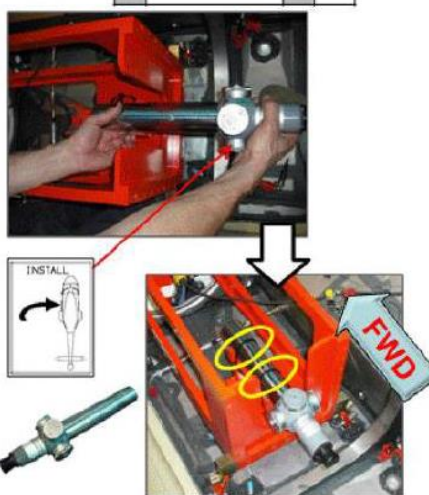

INSTALL

POSITION SCOPE P/N TEC06-147 SECURING IT ON ENGINE MASTER PRISM AND LOCK BY THE USE OF TIE-STRAPS

RIF.	<b>6.2.1.T5</b>	OK	
------	-----------------	----	--

WITH AXES X, Y CURSOR IN 0,0 POSITION MEASURE AND INDICATE WITH A FLAG (↖) IN WHICH OF THE DIAL SECTIONS IS THE TARGET CENTER (1° / 2° / 3° / 4°)

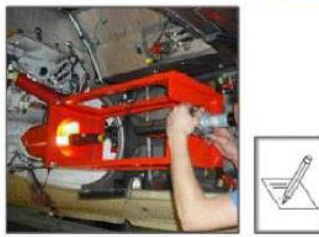

<b>RH ENGINE POSITION SIGHT</b>	
$X_{PENG_{RH}}$	mm
$Y_{PENG_{RH}}$	mm

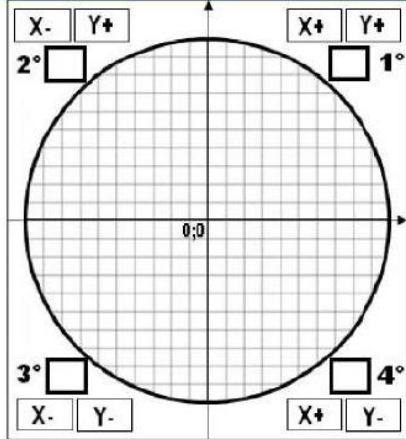

WITH SCOPE P/N TEC06-147 (CURSOR OF AXES X, Y IN POSITION 0,0) SIGHT THE GLASS TARGET AND MEASURE X, Y VALUES. MEASURED VALUES RESPECT TO ZERO SHALL BE INCLUDED WITHIN A 0,4mm DIAMETER. RECORD VALUES IN TABLE.  
TO VERIFY RH ENGINE POSITION TARGET VALUE REFER TO FOLLOWING OPERATIONS.

RIF.	<b>6.2.1.T6</b>	OK	
------	-----------------	----	--

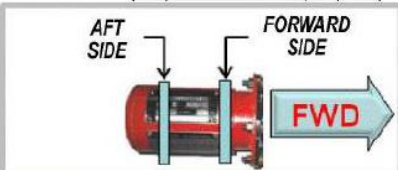
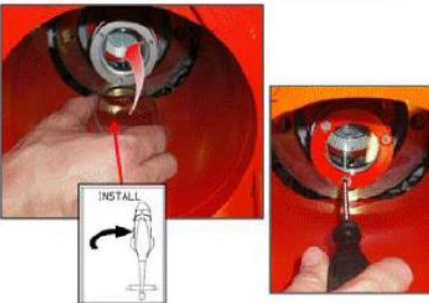



INSTALL

INSTALL ON P/N 3G6310H00111A651A ENGINE OPTICAL SIGHT ADAPTER P/N TEC06-148 TARGET IN AFT SIDE (DISTANCE EQUAL TO 100 mm RESPECT FORWARD SIDE)

RIF.	<b>6.2.1.T7</b>	OK	
------	-----------------	----	--

WITH AXES X, Y CURSOR IN 0,0 POSITION MEASURE AND INDICATE WITH A FLAG (↖) IN WHICH OF THE DIAL SECTIONS IS THE TARGET CENTER (1° / 2° / 3° / 4°)



<b>RH ENGINE ANGLE SIGHT</b>	
$X_{AENG_{RH}}$	mm
$Y_{AENG_{RH}}$	mm

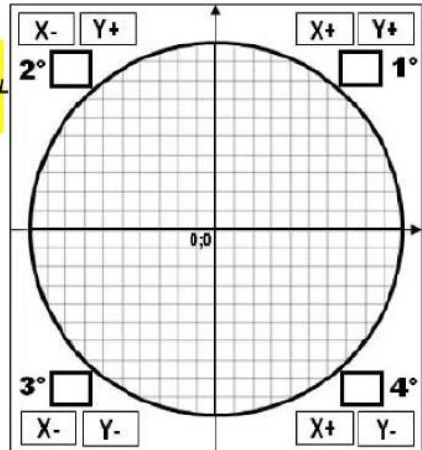

WITH SCOPE P/N TEC06-147 (CURSOR OF AXES X, Y IN POSITION 0,0) SIGHT THE GLASS (AFT SIDE). THE ANGULAR TARGET SHALL BE WITHIN A 0,6mm DIAMETER RESPECT TO THE PREVIOUSLY READ VALUE. READ VALUES AND RECORD IN TABLE.  
TO VERIFY RH ENGINE ANGLE TARGET VALUE REFER TO FOLLOWING OPERATIONS.

BEFORE REMOVING THE EQUIPMENT VERIFY THAT "POSITION" AND "ANGLE" VALUES ARE IN TOLERANCE (SEE FOLLOWING OPERATIONS)

**ENTER THE FLAG IN BOX CORRESPONDING TO THE "ANALYSIS" TYPE THAT WILL BE CARRIED OUT**

**RH ENGINE ALIGNMENT DATA ANALYSIS USING P/N T1396300S1A686A SOFTWARE**



IN THE EVENT THAT TO VERIFY THE ALIGNMENT GOOD QUALITY IT HAS BEEN UTILIZED THE SOFTWARE P/N T1396300S1A686A, ASK FOR THE INTERVENTION OF A QUALITY OPERATOR AND PERFORM OPERATIONS 121 AND 131.



**RECOMMENDED OPTION**

**RH ENGINE ALIGNMENT DATA ANALYSIS USING CALCULATION SHEET**

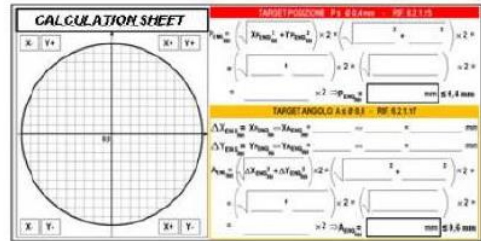

IF CALCULATION SOFTWARE P/N T1396300S1A686A CANNOT BE UTILIZED, REFER TO THE CALCULATION SHEET IN OPERATION 140.



**HAVE CALCULATIONS CERTIFIED BY A QUALITY OPERATOR**

**1** Launch the software file *AW139\_MGB\_ENG\_INSTL\_V.1.0.xls*.

**2** Select "Engine-MGB Alignment Check" and click on "Proceed" button.

**3** Fill in the "INDICATIVE VALUES (AS EXAMPLE)" fields: Operator, Date, Helicopter (31500), Engine Side (Right), Position Target (X: 0.7, Y: 0.7), and Angle Target (X: 0.7, Y: 0.7). Click on "Proceed" button.

**SELECT ENGLISH LANGUAGE FROM THE PREFERENCE MENU**

**SELECT "RIGHT"**

**LAUNCH P/N T1396300S1A686A SOFTWARE FROM FILE AW139\_MGB\_ENG\_INSTL\_V.1.0.xls.(1). SELECT "ENGINE-MGB ALIGNMENT CHECK" AND CLICK ON PROCEED BUTTON(2). FILL CAREFULLY THE HIGHLIGHTED FIELDS ENTERING ALL DATA RELEVANT TO THE CHECK AND CLICK ON PROCEED BUTTON(3).**

- TO BE ABLE TO EXECUTE THE APPLICATION IT IS NECESSARY TO BE IN POSSESSION OF A MICROSOFT EXCEL COPY IN WHICH IT IS SPECIFIED A MEDIUM-LOW LEVEL OF MACRO PROTECTION (INSTRUMENTS/MACRO/PROTECTION MENU). IT IS ALSO NECESSARY TO SET THE "." FULL STOP AS DECIMALS SEPARATION SYMBOL, BY OPENING WINDOWS CONTROL PANEL AT INTERNATIONAL OPTION ITEM.
- IF AFTER SOFTWARE HAS BEEN LAUNCHED THE WINDOW "OPTIONS/PREFERENCES/CREDITS DOES NOT APPEAR, CLICK ON "AVVIO/START" BUTTON.

RIF. **7.1.T2** OK

INDICATIVE VALUES (AS EXAMPLE)

AW139\_MGR\_ENG\_INST\_V\_1.0

Mario Rossi, 01.01.01  
Helicopter 31100, Right Engine Side

Engine Shaft Diaphragm Misalignment Check	Engine Shaft Spline Misalignment Check
0° 1' 33"	0° 1' 33"
Allowable 0°, 10', 00"	Allowable 0°, 3', 00"

Proceed Back Cancel

AW139\_MGR\_ENG\_INST\_V\_1.0

Mario Rossi, 01.01.01  
Helicopter 31100, Right Engine Side

Engine Shaft Diaphragm Misalignment Check	Engine Shaft Spline Misalignment Check
0° 31' 9"	0° 31' 9"
Allowable 0°, 10', 00"	Allowable 0°, 3', 00"

Proceed Back Cancel

COLORS LEGEND

POSITIVE CHECK RESULT     NEGATIVE CHECK RESULT

THE SOFTWARE WILL AUTOMATICALLY DISPLAY THE TEST VALUES AND RESULTS: GREEN = POSITIVE RESULT; RED = NEGATIVE RESULT.

RIF. **T3** OK

- DISALIGNMENT CHECK REPORT -

Engine Shaft Diaphragm Misalignment Check	Engine Shaft Spline Misalignment Check
Allowable 0°, 10', 00"	Allowable 0°, 3', 00"

SING FOR CHECK POSITIVE RESULT

CALCULUS CHECK QUALITY APPVL.

RECORD THE OBTAINED FINAL DISALIGNMENT VALUES

**FOGLIO DI CALCOLO**  
**CALCULATION SHEET**

X-

Y+

X+

Y+

X-

Y-

X+

Y-

**TARGET POSIZIONE (POSITION TARGET) P ≤ 0,4 mm - RIF. 6.2.1.T5**

$$P_{ENG_{RH}} = \left( \sqrt{X_{P_{ENG_{RH}}}^2 + Y_{P_{ENG_{RH}}}^2} \right) \times 2 = \left( \sqrt{\quad^2 + \quad^2} \right) \times 2 =$$

$$= \left( \sqrt{\quad + \quad} \right) \times 2 = \left( \sqrt{\quad} \right) \times 2 =$$

$$= \quad \times 2 \Rightarrow P_{ENG_{RH}} = \quad \text{mm} \leq 0,4 \text{ mm}$$

**TARGET ANGOLO (ANGLE TARGET) A ≤ 0,6 - RIF. 6.2.1.T7**





$$\Delta X_{ENG_{RH}} = X_{P_{ENG_{RH}}} - X_{A_{ENG_{RH}}} = \quad = \quad = \quad \text{mm}$$



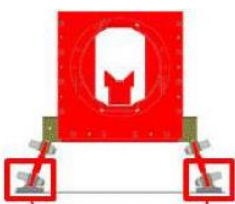

$$\Delta Y_{ENG_{RH}} = Y_{P_{ENG_{RH}}} - Y_{A_{ENG_{RH}}} = \quad = \quad = \quad \text{mm}$$

$$A_{ENG_{RH}} = \left( \sqrt{\Delta X_{ENG_{RH}}^2 + \Delta Y_{ENG_{RH}}^2} \right) \times 2 = \left( \sqrt{\quad^2 + \quad^2} \right) \times 2 =$$

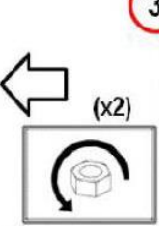
$$= \left( \sqrt{\quad + \quad} \right) \times 2 = \left( \sqrt{\quad} \right) \times 2 =$$

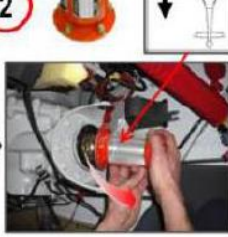
$$= \quad \times 2 \Rightarrow A_{ENG_{RH}} = \quad \text{mm} \leq 0,6 \text{ mm}$$

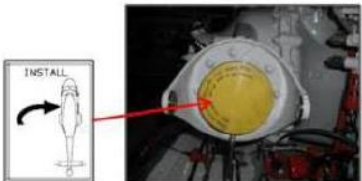
RIF.	<b>T4</b>	OK			
					
					
<p>AL TERMINE DELL'ATTIVITA' RIMUOVERE IL CANNOCCHIALE P/N TEC06-147 DAL SIMULACRO (1). SUCCESSIVAMENTE RIMUOVERE IL SIMULACRO P/N 3G6310H00111A651A (2).          UPON ACTIVITY COMPLETION REMOVE SCOPE P/N TEC06-147 FROM MOCK-UP (1). AFTERWARDS REMOVE MOCK-UP P/N 3G6310H00111A651A (2).</p>					

RIF.	<b>T5</b>	OK			
					
					
<p>REMOVE ENGINE OPTICAL SIGHT ADAPTER P/N 3G6310H00111A651A FROM RH FLANGE(1)(2). REMOVE TARGET P/N TEC06-148 FROM ADAPTER(3). FINALLY INSTALL COVER ON RH ENGINE DRIVE QUILL FLANGE(4).</p>					
<p>STORE ALL EQUIPMENT UTILIZED FOR THE ALIGNMENT ACTIVITY.</p>					

**Annex B**

<p><b>NOTES:</b></p> <ul style="list-style-type: none"> <li>Ⓐ 1) LH/RH FWD EXTERNAL DOUBLER MATERIAL: PLATE CRES 301 CONDITION 1/4H AMS5517 THICKNESS 0.41 MM.</li> <li>Ⓐ 2) LH/RH FWD INTERNAL DOUBLER MATERIAL: PLATE CRES 301 CONDITION 1/4H AMS5517 THICKNESS 0.64 MM.</li> <li>Ⓐ 3) LH/RH AFT EXTERNAL DOUBLER MATERIAL: PLATE CRES 301 CONDITION 1/4H AMS5517 THICKNESS 0.41 MM.</li> <li>Ⓐ 4) LH/RH AFT INTERNAL DOUBLER MATERIAL: PLATE CRES 301 CONDITION 1/4H AMS5517 THICKNESS 0.64 MM.</li> <li>5) RIVETING PROCEDURE I.A.W. 39-A-51-41-01-00A-010A-A</li> <li>6) UNLESS OTHERWISE STATED BREAK SHARP EDGES WITH RADIUS 0, 13*0, 38 MM.</li> <li>7) ADAPT PIECES DURING INSTALLATION.</li> <li>8) DEBURR ALL HOLES AND BREAK SHARP EDGES WITH RADIUS 0, 13*0, 38 MM</li> <li>9) FOR BONDING PROCEDURE REFER TO 39-A-51-62-00-00A-010A-A</li> <li>10) APPLY PRIMER UNLESS OTHERWISE STATED I.A.W. 39-A-51-61-01-00A-010A-A</li> </ul>	
<p>For Paolo Angelo Fedele - Head of Repair Design - AgustaWestland</p> <p>Part Name _____ S/N _____ T.T _____</p> <p>P/N _____ S/N _____ T.T _____</p> <p>This is a _____ repair approved with ref. to NTR- _____</p> <p>Authorized signature as per DDA manual C39-02-002          This repair design approved only covers design aspects and excludes workmanship aspects.          It has been prepared for a specific helicopter or component, based on original AgustaWestland type Certificate, and solely on the basis of the information supplied to AgustaWestland; this repair approval is not to be used for any other helicopter or component or any other purposes than for which it was supplied without the written approval of AgustaWestland DDA</p>	
<p style="text-align: center;"> A Finmeccanica Company</p> <p style="text-align: center;"><b>REPAIR ENGINEERING</b></p>	
<p><b>TITLE:</b> RH/LH PROFILE WL 2670.0 REPAIR Ⓐ</p>	
<p><b>GROUP ENGINEER:</b> P. FEDELE</p>	<p><b>DATE:</b> 09/04/2014</p>
<p><b>SHEET</b> 1 OF 8</p>	<p><b>SKETCH N°</b> SK139-877</p>
<p>THIS DOCUMENT CONTAINS CONFIDENTIAL INFORMATION AND IT IS SUPPLIED ON THE EXPRESS CONDITION THAT IT MAY NOT BE DISCLOSED, REPRODUCED IN WHOLE OR IN PART, OR USED FOR MANUFACTURE FOR ANYONE OTHER THAN AGUSTA WITHOUT ITS WRITTEN CONSENT.</p>	
<p><b>REVISION:</b> Ⓐ DATE: 18/07/2014</p> <p><b>EXTENDED APPLICABILITY TO LH SIDE</b></p>	<p><b>ISS:</b> A</p>

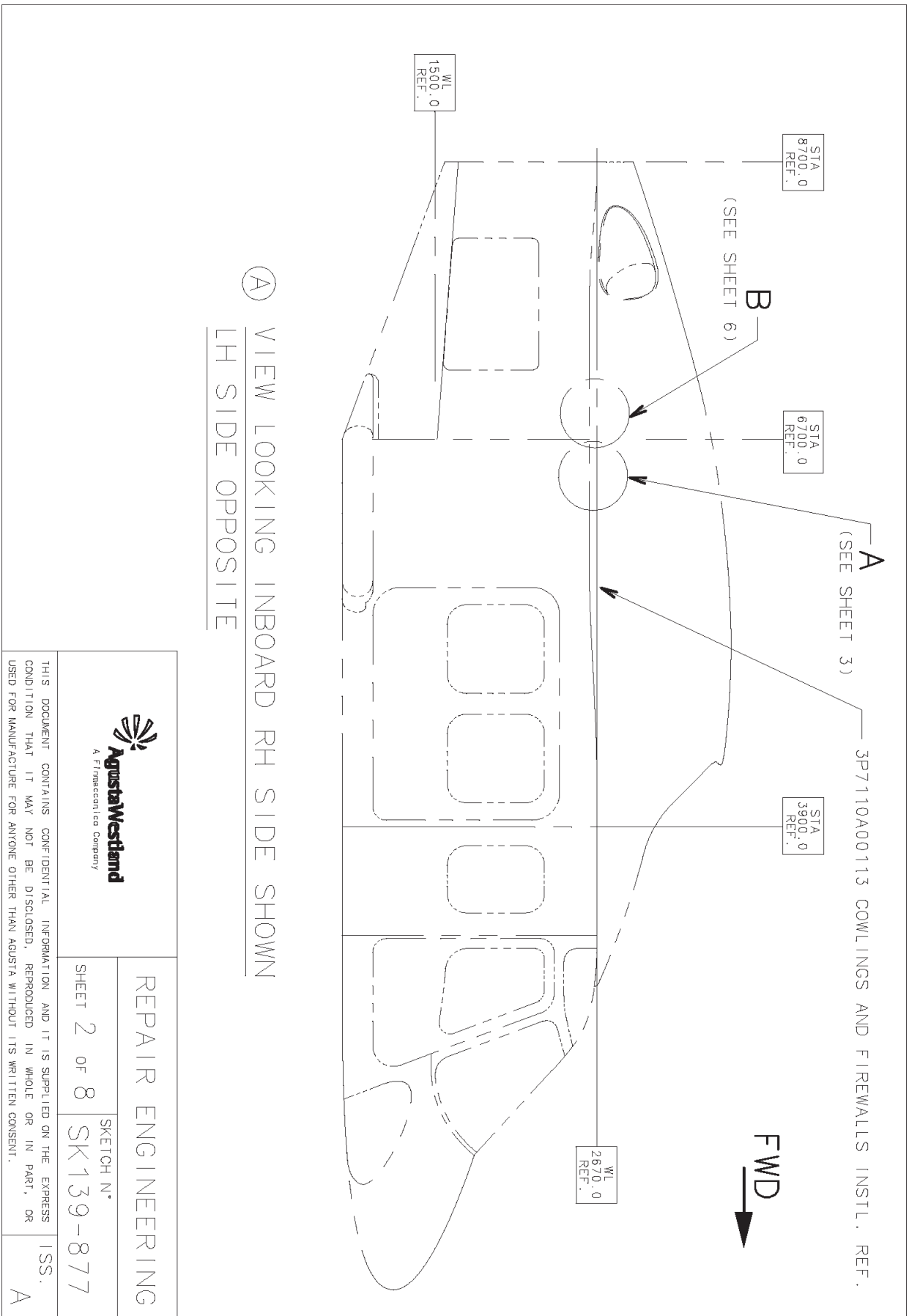

 <p>AgustaWestland A Finmeccanica Company</p>	REPAIR ENGINEERING	
	SHEET 2 OF 8	SKETCH N° SK 139-877
<p>THIS DOCUMENT CONTAINS CONFIDENTIAL INFORMATION AND IT IS SUPPLIED ON THE EXPRESS CONDITION THAT IT MAY NOT BE DISCLOSED, REPRODUCED IN WHOLE OR IN PART, OR USED FOR MANUFACTURE FOR ANYONE OTHER THAN AGUSTA WITHOUT ITS WRITTEN CONSENT.</p>		ISS. A



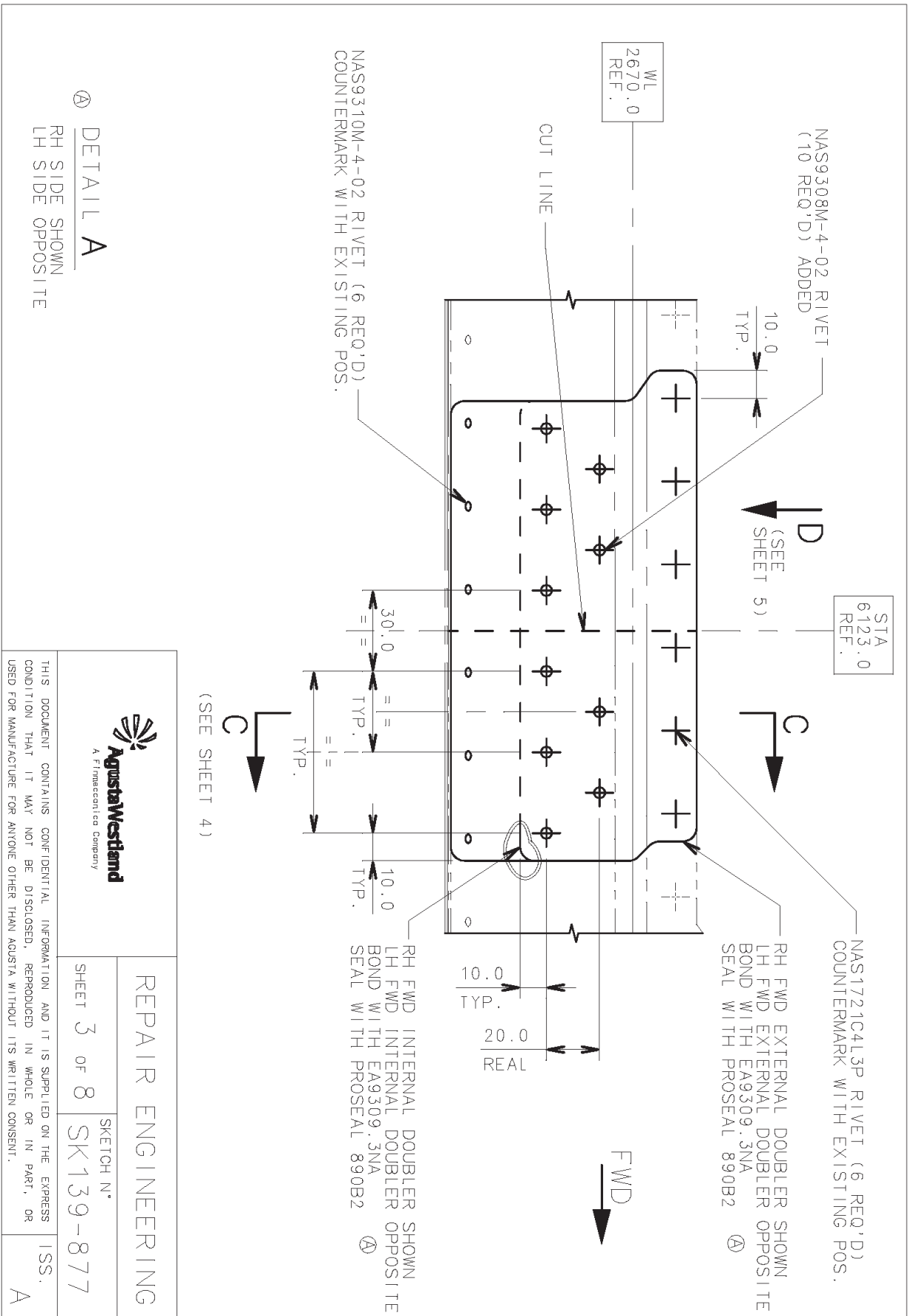

ⓐ **DETAIL A**  
 RH SIDE SHOWN  
 LH SIDE OPPOSITE

 A Finmeccanica Company	<b>REPAIR ENGINEERING</b>	
	SHEET 3 OF 8	SKETCH N° SK139-877
THIS DOCUMENT CONTAINS CONFIDENTIAL INFORMATION AND IT IS SUPPLIED ON THE EXPRESS CONDITION THAT IT MAY NOT BE DISCLOSED, REPRODUCED IN WHOLE OR IN PART, OR USED FOR MANUFACTURE FOR ANYONE OTHER THAN AGUSTA WITHOUT ITS WRITTEN CONSENT.		ISS. A

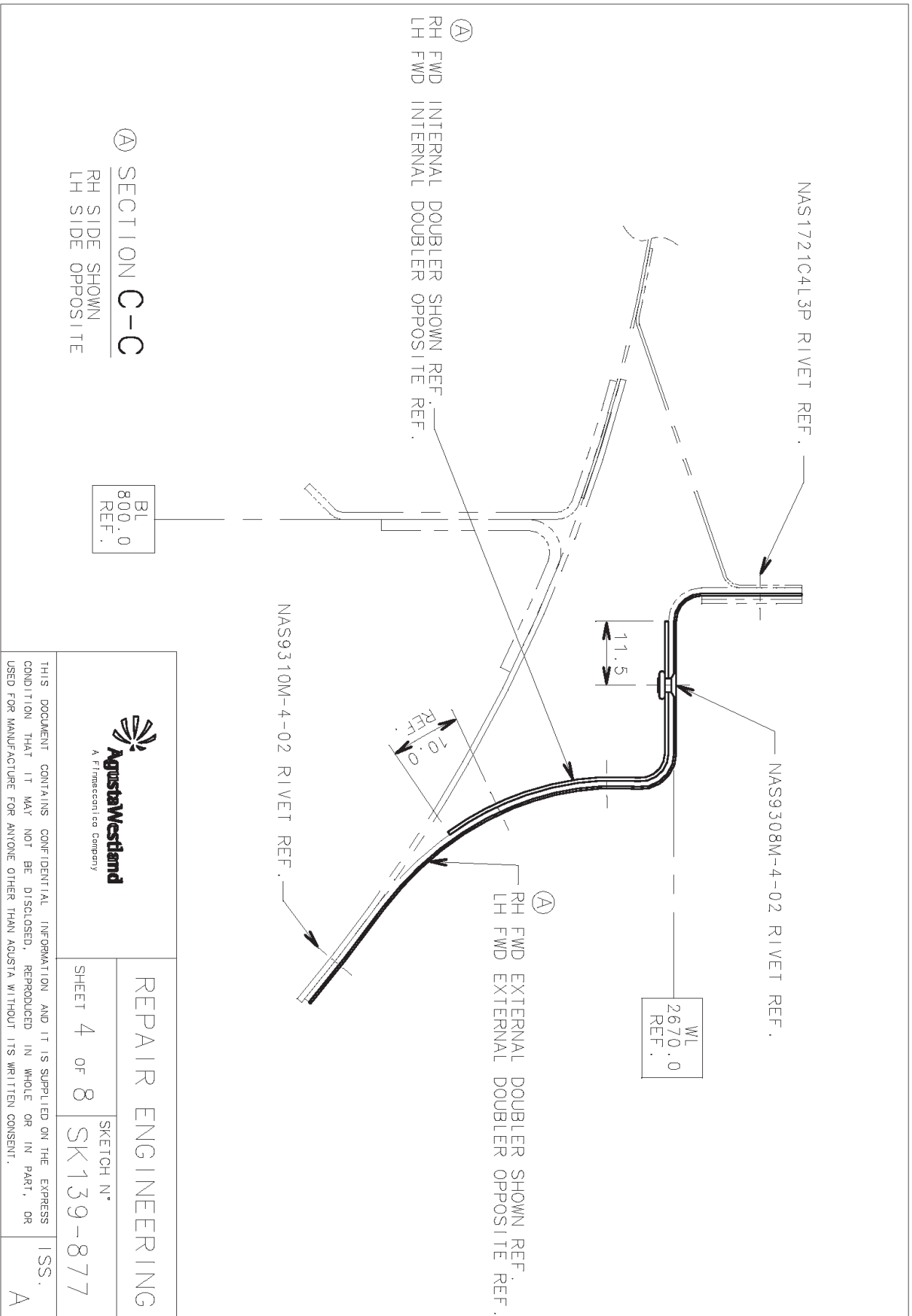

 AgustaWestland A Finmeccanica Company	REPAIR ENGINEERING	
	SHEET 4 OF 8	SKETCH N° SK139-877
THIS DOCUMENT CONTAINS CONFIDENTIAL INFORMATION AND IT IS SUPPLIED ON THE EXPRESS CONDITION THAT IT MAY NOT BE DISCLOSED, REPRODUCED IN WHOLE OR IN PART, OR USED FOR MANUFACTURE FOR ANYONE OTHER THAN AGUSTA WITHOUT ITS WRITTEN CONSENT.		ISS. A

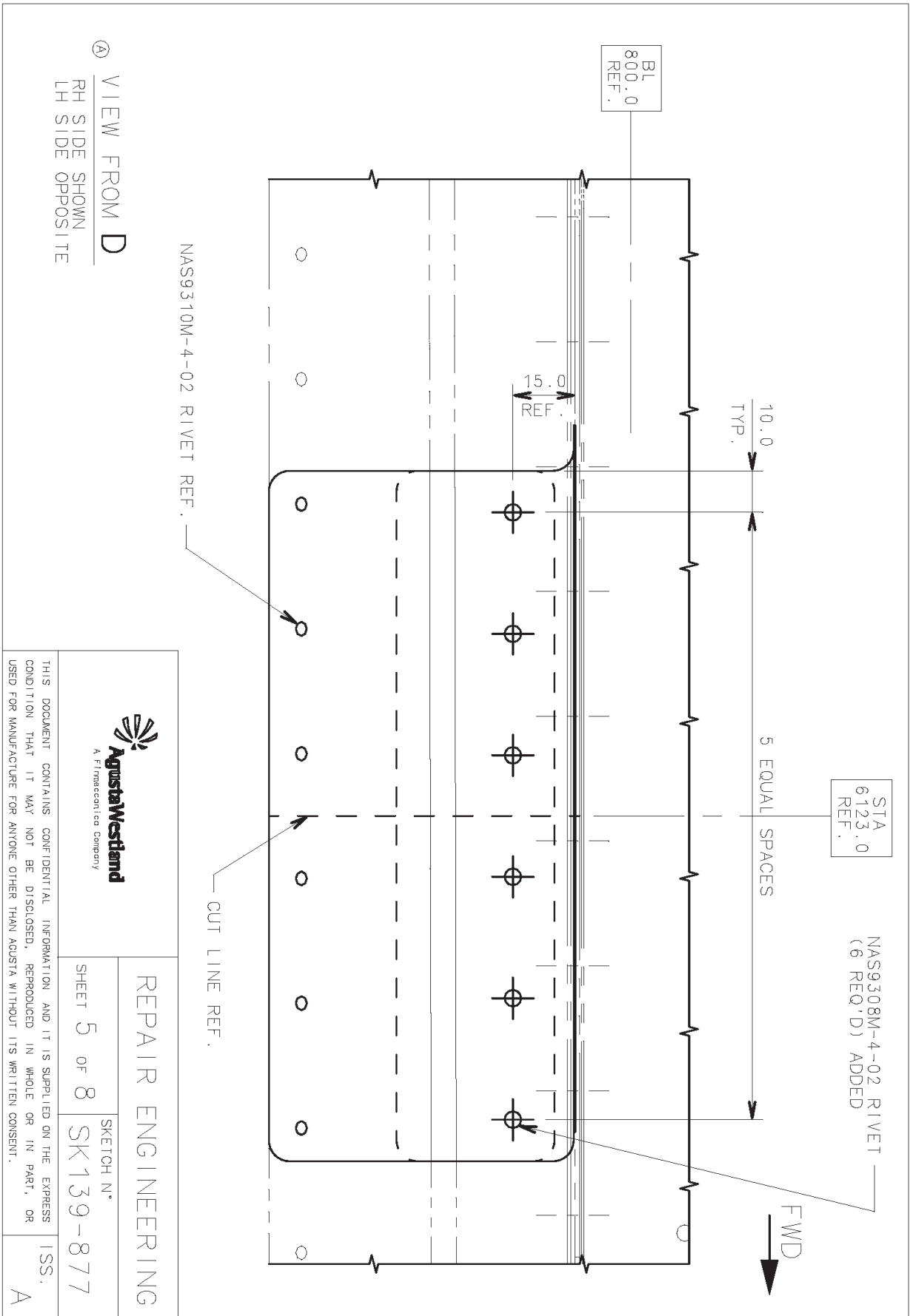

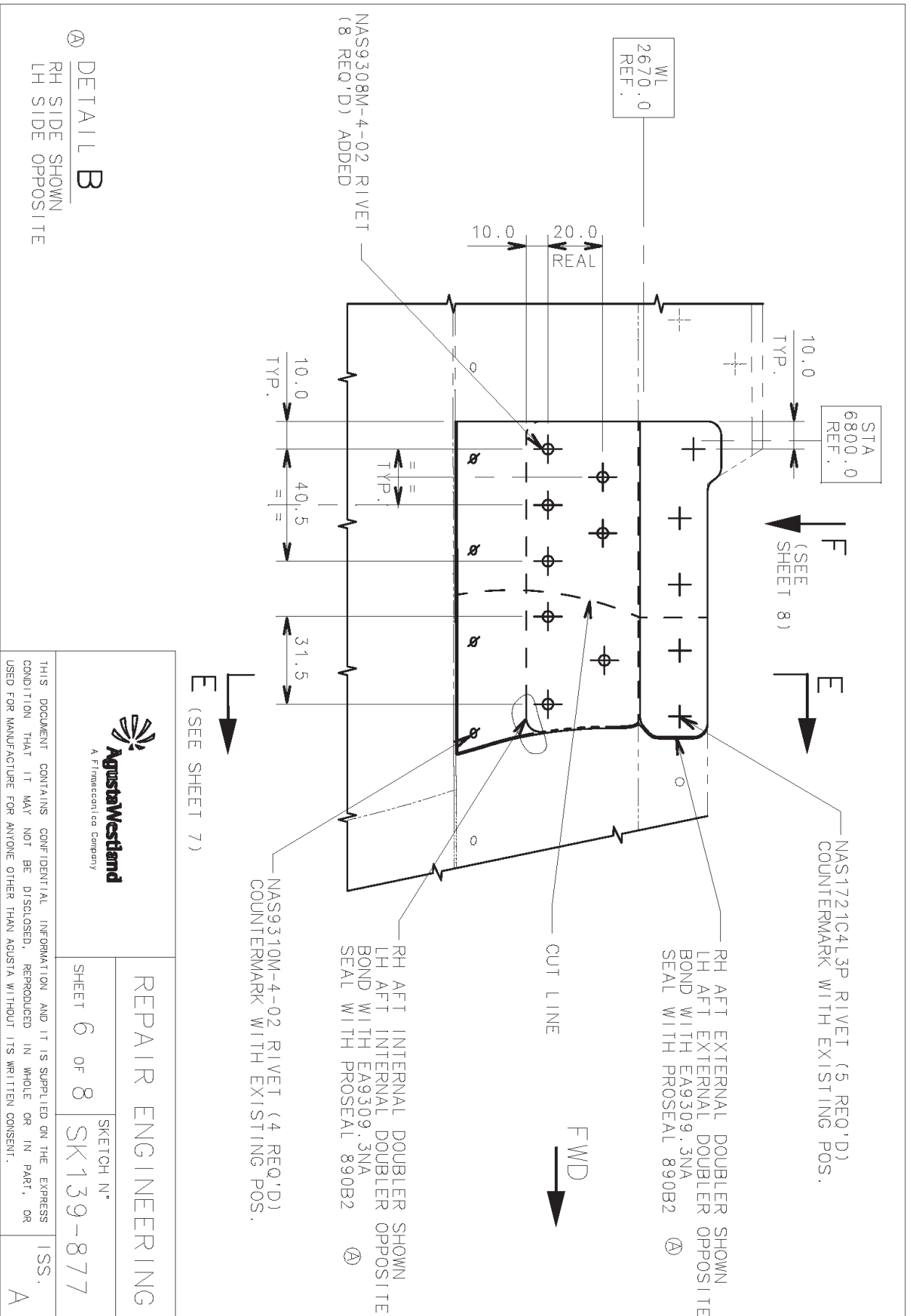

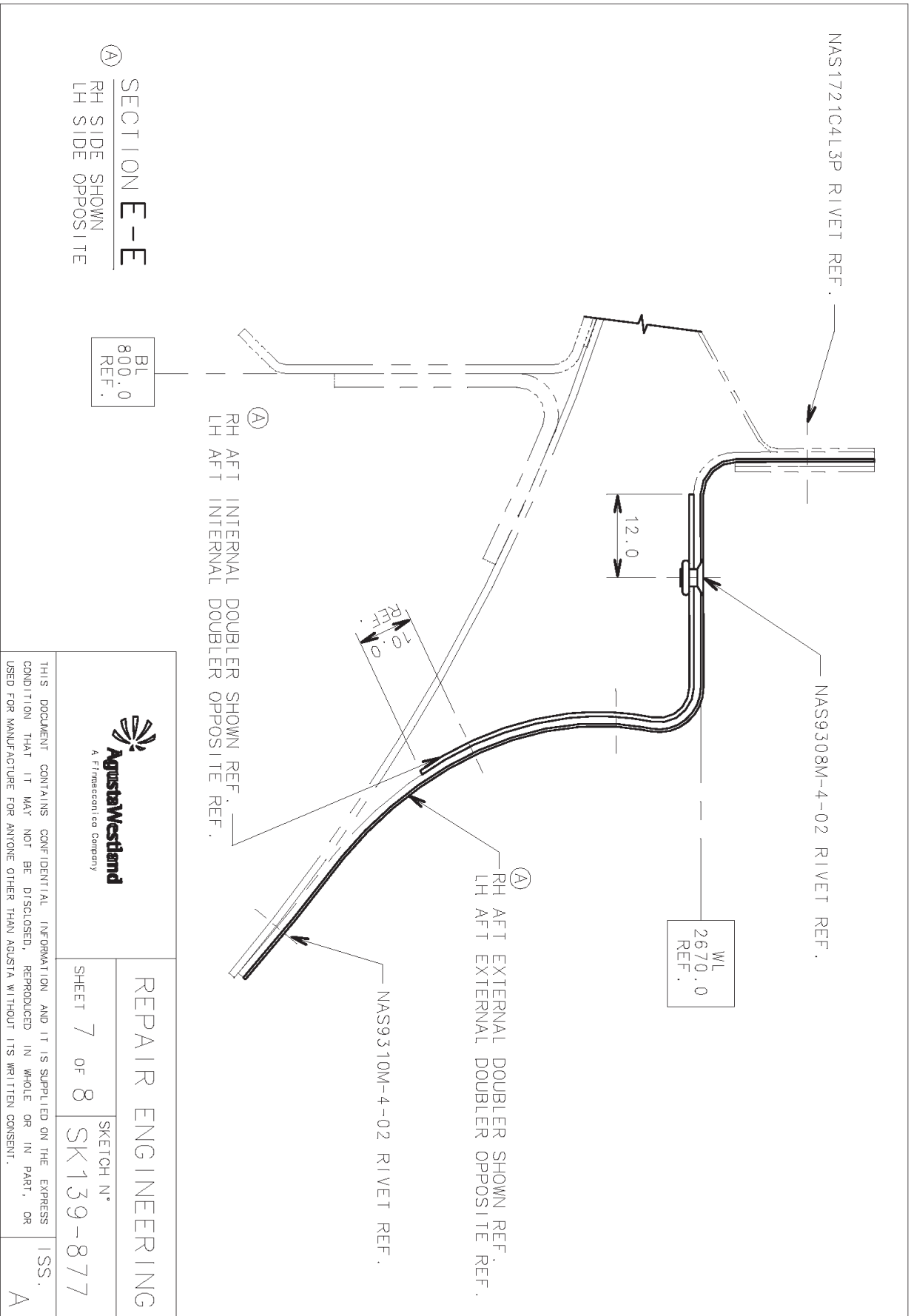

REPAIR ENGINEERING

SHEET 7 OF 8 SKETCH N° SK139-877

THIS DOCUMENT CONTAINS CONFIDENTIAL INFORMATION AND IT IS SUPPLIED ON THE EXPRESS CONDITION THAT IT MAY NOT BE DISCLOSED, REPRODUCED IN WHOLE OR IN PART, OR USED FOR MANUFACTURE FOR ANYONE OTHER THAN AGUSTA WITHOUT ITS WRITTEN CONSENT.

ISS. A

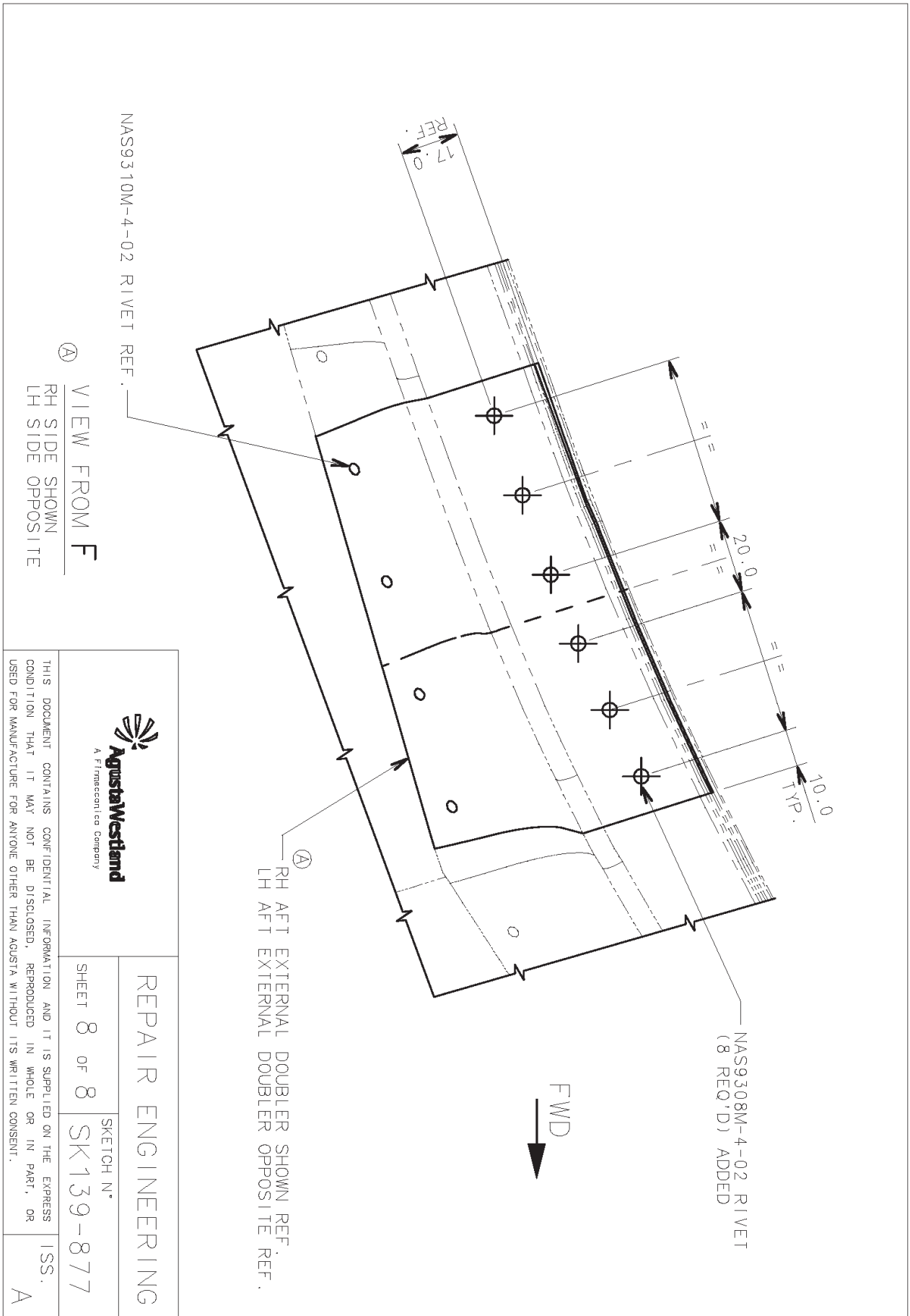

REPAIR ENGINEERING

SKETCH N°

SHEET 8 of 8 SK139-877

ISS. A

THIS DOCUMENT CONTAINS CONFIDENTIAL INFORMATION AND IT IS SUPPLIED ON THE EXPRESS CONDITION THAT IT MAY NOT BE DISCLOSED, REPRODUCED IN WHOLE OR IN PART, OR USED FOR MANUFACTURE FOR ANYONE OTHER THAN AGUSTA WITHOUT ITS WRITTEN CONSENT.

NOTES:

- 1) LH/RH UPPER DOUBLER MATERIAL: PLATE CRES 301 CONDITION 1/4H AMS5517 THICKNESS 3.64 MM.
- 2) LH/RH DOUBLER MATERIAL: PLATE CRES 301 CONDITION 1/4H AMS5517 THICKNESS 0.51 MM.
- 3) DEBURR ALL HOLES AND BREAK SHARP EDGES WITH RADIUS 3, 13\*0, 38 MM.
- 4) ADAPT PIECES DURING INSTALLATION.
- 5) RIVETING PROCEDURE I.A.W. CSRPA-A-51-41-00-00A-663A-D
- 6) TREAT BARE ALUMINIUM SURFACES I.A.W. CSRPA-A-51-21-05-00A-644A-D
- 7) FOR BONDING PROCEDURE REFER TO CSRPA-A-51-22-00-00A-328A-D
- 8) APPLY PRIMER A.W. CSRA-A-51-21-02-00A-028A-D

Paolo Argello Fedele - Head of Repair Design - Finmeccanica Helicopter Division For S/N 1.1				REPAIR ENGINEERING	
Part Name S/N T.I This is a repair approved with ref. to NFR-					
Authorized signature as per DOA manual C750-02-002 This repair design approval only covers design aspects and excludes workmanship aspects. It has been prepared for a specific helicopter or component, based on original Finmeccanica Helicopter Div. Type Certificate and solely on the basis of the information supplied to Finmeccanica Helicopter Division. This repair approval is not to be used for any other helicopter or component, or any other purposes than for which it was supplied without the written approval of Finmeccanica Helicopter Division DOA.		GROUP ENGINEER: P. FEDELE DATE: 13/09/2016		SHEET 1 OF 8 SKETCH N° 139-1474	
THIS DOCUMENT CONTAINS CONFIDENTIAL INFORMATION AND IT IS SUPPLIED ON THE EXPRESS CONDITION THAT IT MAY NOT BE DISCLOSED, REPRODUCED IN WHOLE OR IN PART, OR USED FOR MANUFACTURE FOR ANYONE OTHER THAN FINMECCANICA HELICOPTER DIVISION WITHOUT ITS WRITTEN CONSENT.				ISS. /	

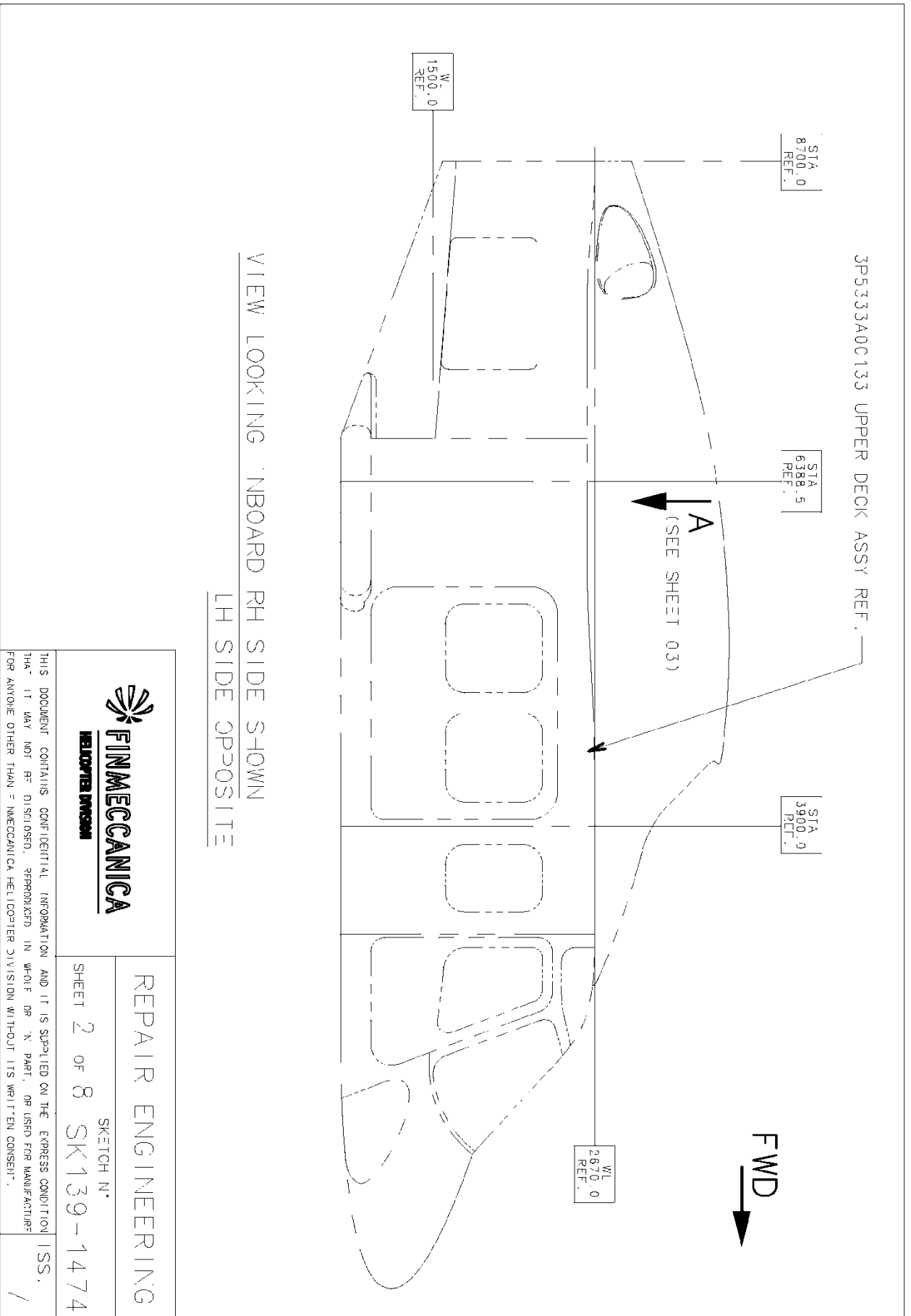

	
REPAIR ENGINEERING	SKETCH N°
SHEET 2 OF 8	SK 139-1474
<small>THIS DOCUMENT CONTAINS CONFIDENTIAL INFORMATION AND IT IS SUPPLIED ON THE EXPRESS CONDITION THAT IT MAY NOT BE DISCLOSED, REPRODUCED IN WHOLE OR IN PART, OR USED FOR MANUFACTURE FOR ANYONE OTHER THAN FINMECCANICA HELICOPTER DIVISION WITHOUT ITS WRITTEN CONSENT.</small>	
/	/



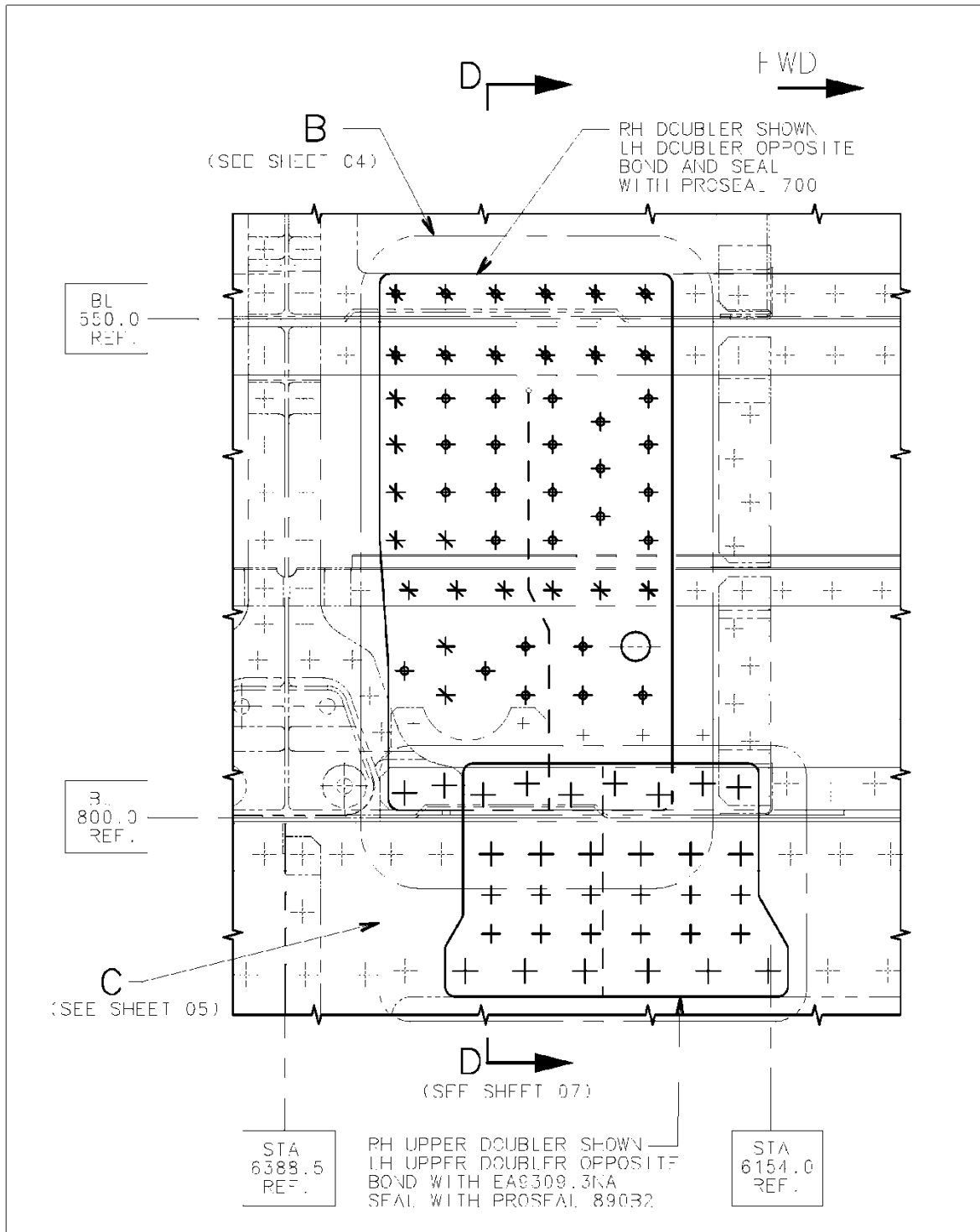

VIEW FROM A  
 RH SIDE SHOWN  
 LH SIDE OPPOSITE

	REPAIR ENGINEERING	
	SHEET 3 OF 8	SKETCH N° SK139-1474
<small>THIS DOCUMENT CONTAINS CONFIDENTIAL INFORMATION AND IT IS SUPPLIED ON THE EXPRESS CONDITION THAT IT MAY NOT BE DISCLOSED, REPRODUCED IN WHOLE OR IN PART, OR USED FOR MANUFACTURE FOR ANYONE OTHER THAN FINMECCANICA HELICOPTER DIVISION WITHOUT ITS WRITTEN CONSENT.</small>		ISS. /

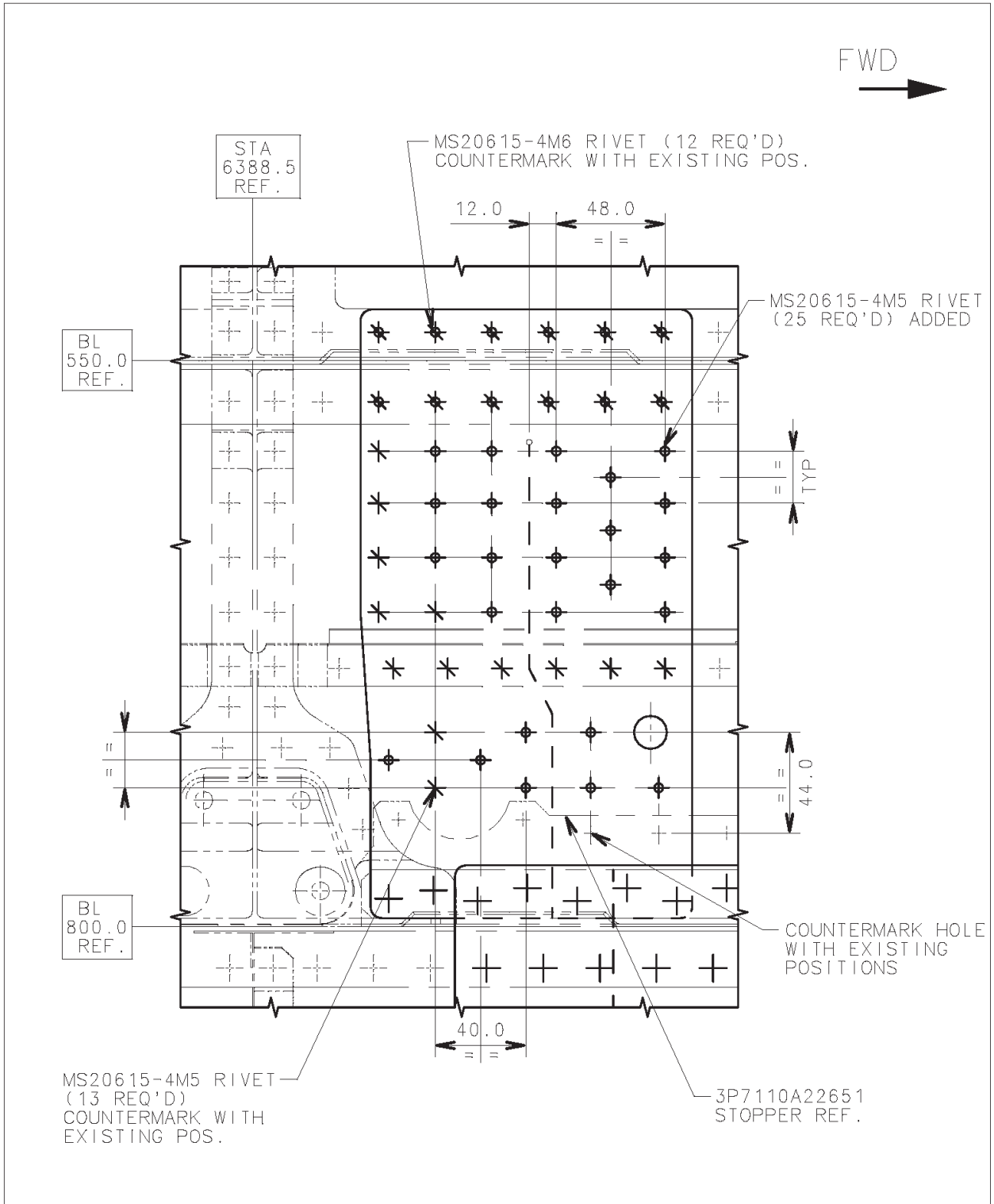

DETAIL B  
RH SIDE SHOWN  
LH SIDE OPPOSITE

	REPAIR ENGINEERING	
	SHEET 4 OF 8	SKETCH N° SK139-1474
<small>THIS DOCUMENT CONTAINS CONFIDENTIAL INFORMATION AND IT IS SUPPLIED ON THE EXPRESS CONDITION THAT IT MAY NOT BE DISCLOSED, REPRODUCED IN WHOLE OR IN PART, OR USED FOR MANUFACTURE FOR ANYONE OTHER THAN FINMECCANICA HELICOPTER DIVISION WITHOUT ITS WRITTEN CONSENT.</small>		ISS. /

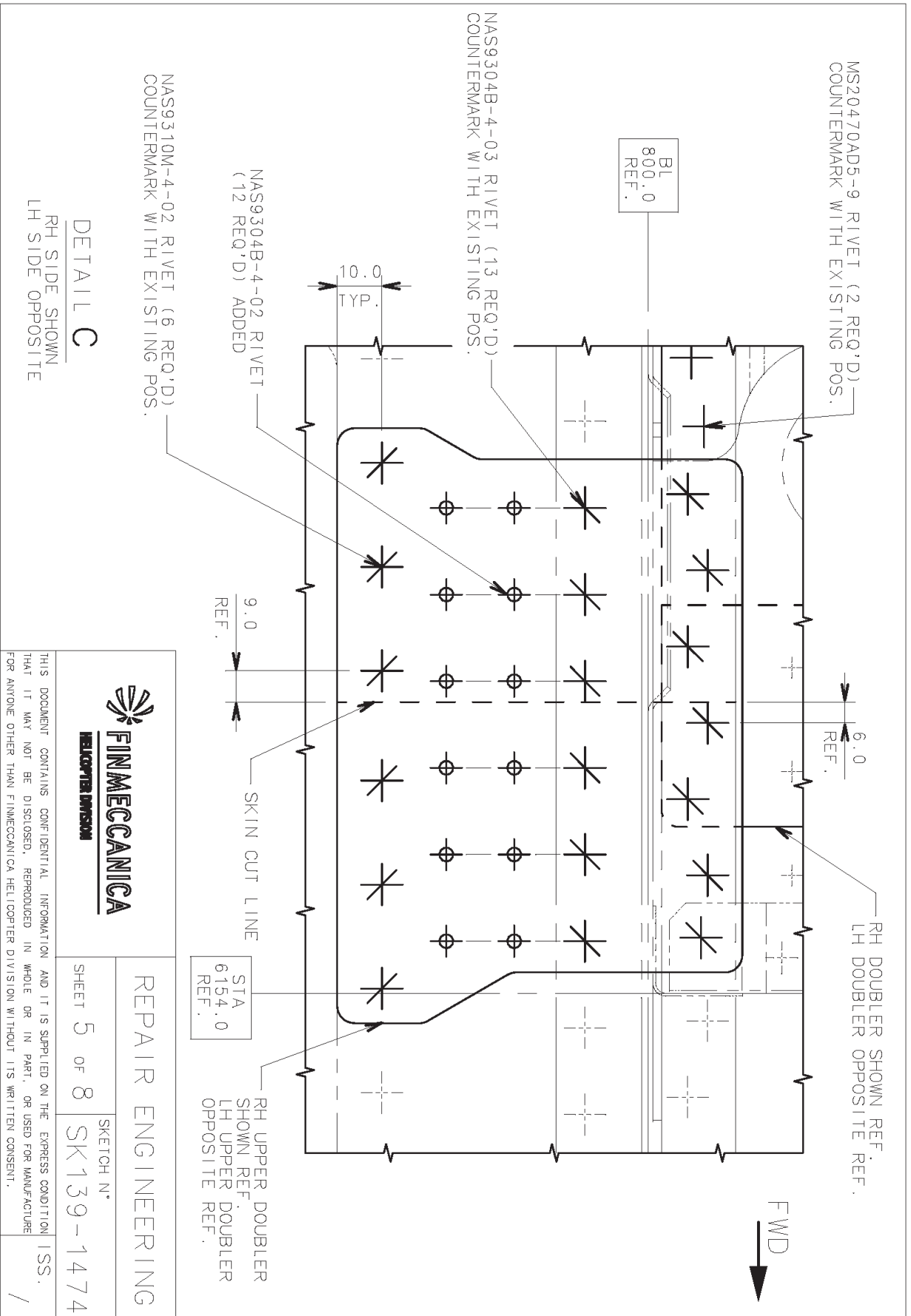

**FINMECCANICA**  
HELICOPTER DIVISION

REPAIR ENGINEERING

SHEET 5 OF 8 SKETCH N° SK 139-1474

THIS DOCUMENT CONTAINS CONFIDENTIAL INFORMATION AND IT IS SUPPLIED ON THE EXPRESS CONDITION THAT IT MAY NOT BE DISCLOSED, REPRODUCED IN WHOLE OR IN PART, OR USED FOR MANUFACTURE FOR ANYONE OTHER THAN FINMECCANICA HELICOPTER DIVISION WITHOUT ITS WRITTEN CONSENT.

ISS. /

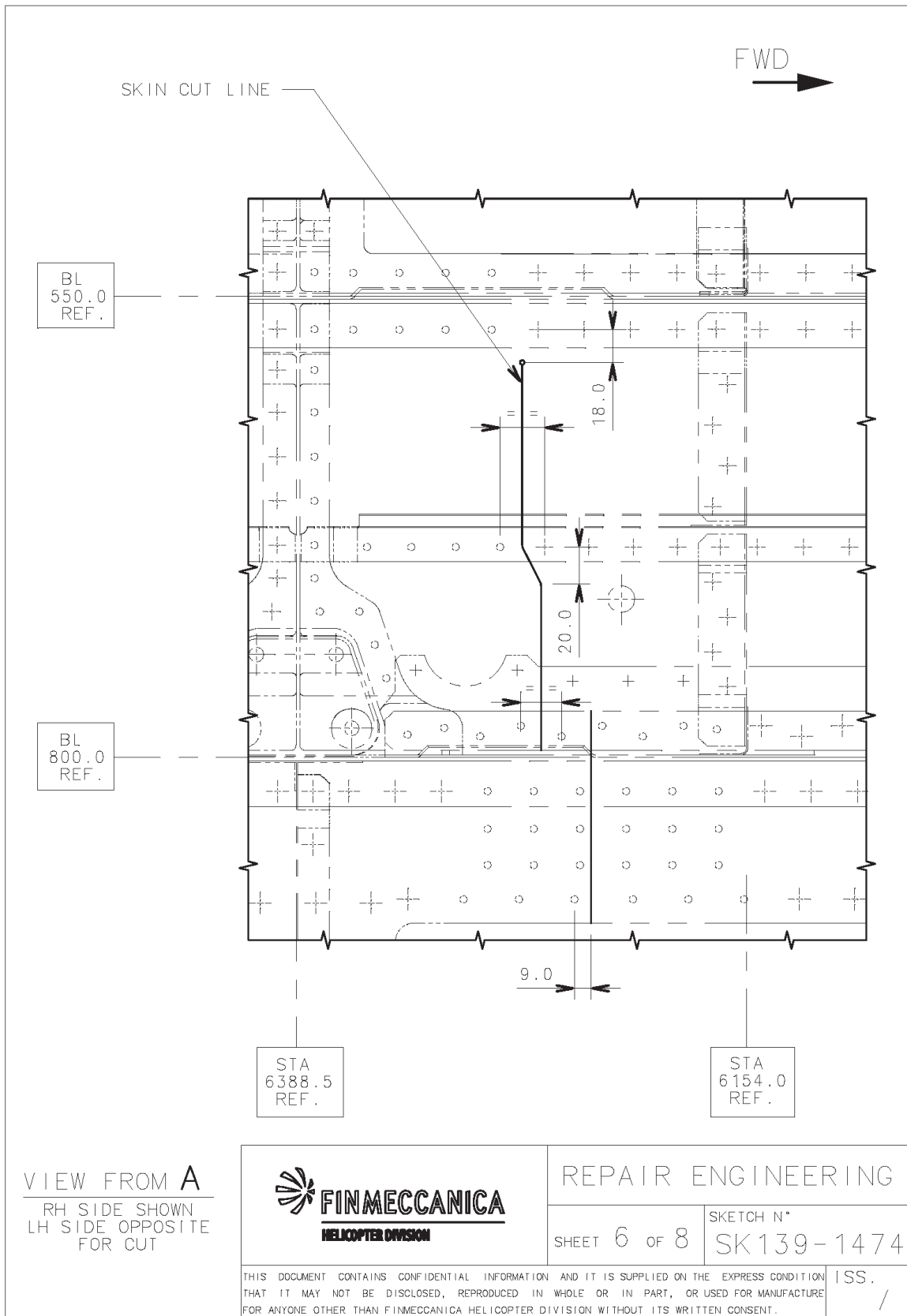

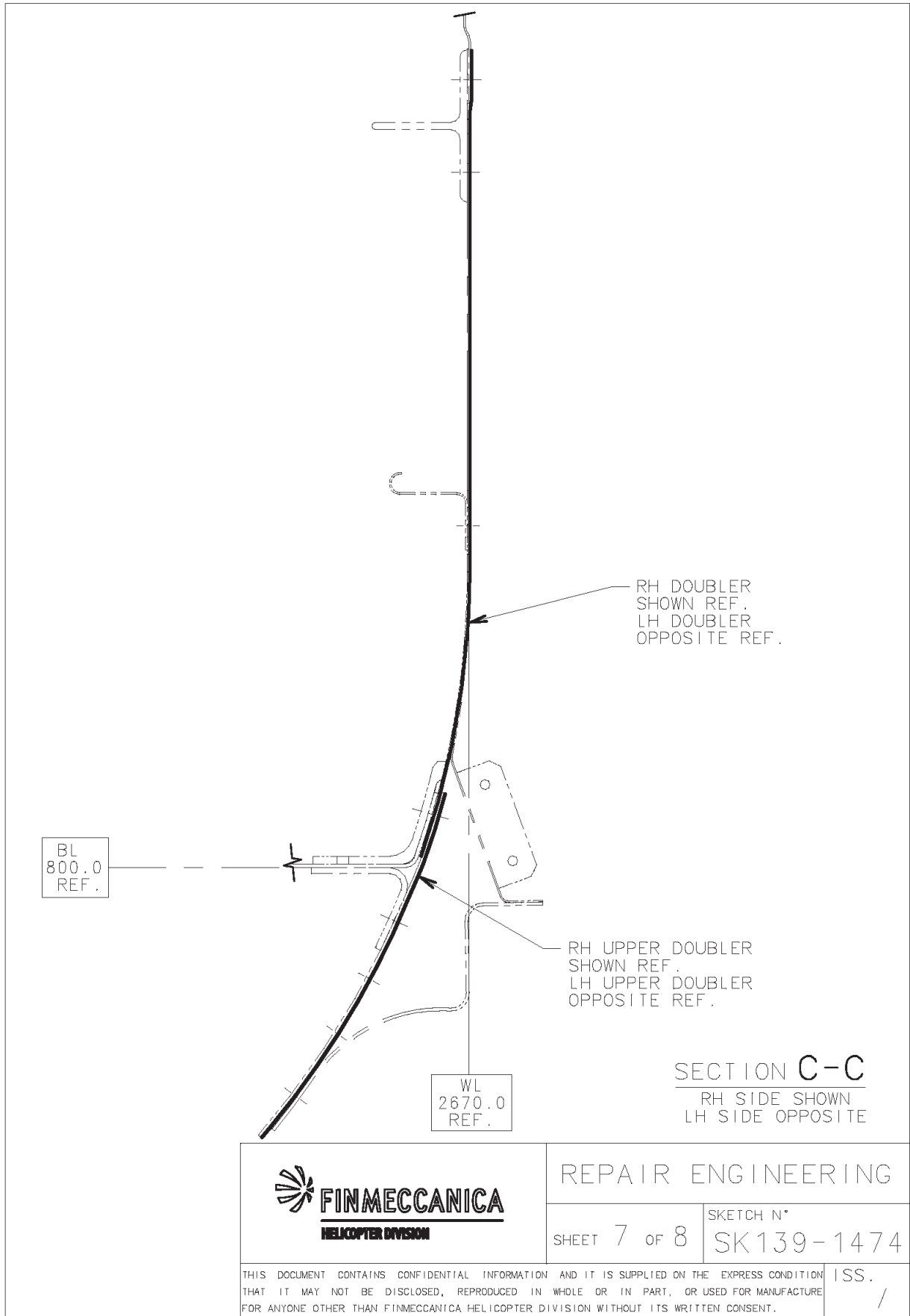

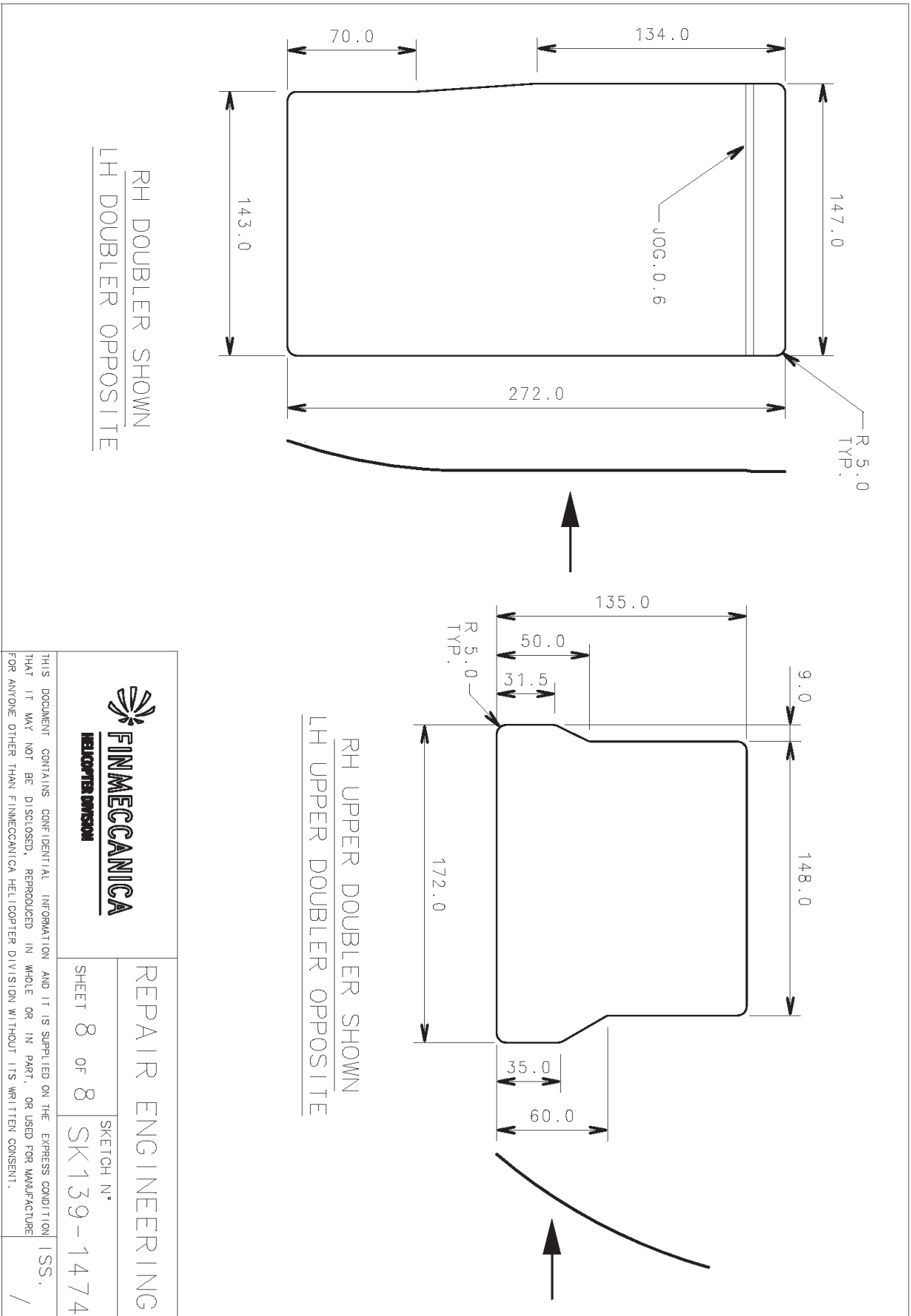

	REPAIR ENGINEERING	
	SHEET 8 OF 8	SKETCH N° SK 139-1474
<small>THIS DOCUMENT CONTAINS CONFIDENTIAL INFORMATION AND IT IS SUPPLIED ON THE EXPRESS CONDITION THAT IT MAY NOT BE DISCLOSED, REPRODUCED IN WHOLE OR IN PART, OR USED FOR MANUFACTURE FOR ANYONE OTHER THAN FINMECCANICA HELICOPTER DIVISION WITHOUT ITS WRITTEN CONSENT.</small>		ISS. /