SERVICE BULLETIN

N° 139-564

DATE: October 12, 2022

REV. : /

TITLE

**ATA 00 – AV900 CABIN STATION, POWER SOCKET AND AVIONIC VARIANT
INSTALLATION**

REVISION LOG

First Issue

1. PLANNING INFORMATION

A. EFFECTIVITY

AW139 helicopters S/N 31795 and S/N 31799.

B. COMPLIANCE

At Customer's option.

C. CONCURRENT REQUIREMENTS

N.A.

D. REASON

This Service Bulletin is issued in order to provide the necessary instructions on how to perform the installation of:

- the ICS AV900 cab station 4 P/N 4G2350F00914;
- the audio customization upgrade (structural provision P/N 3G5311A41211 and electrical provision P/N 3G2350P04911);
- the power socket (structural provision P/N 3G5311A41011 and electrical provision P/N 3G2460A04811);
- the cabin liners retromod for D.A.W. (fiber) P/N 3G2580P21111;
- the utility CB panel elect provision P/N 3G4620A00611;
- the AUX O/H PNL retromod P/N 3G2460P01026.

E. DESCRIPTION

The ICS AV900 cab station 4 consist of the ICS AV900 cabin station 4 electrical provision P/N 4G2350A03412 (installation of C/A A2B298, C/A B1A433, C/A B2A299, C/A B2A301, C/A B2B319 and relevant fixing hardware) and the ICS AV900 cabin station 4 electrical installation P/N 4G2350A03211 (installation of AV900 audio panel P/N 7511900-99002).

The audio customization upgrade Dubai structural provision P/N 3G5311A41211 consist of the installation of the bracket P/N 3G5317A88151, the support assy P/N 3G5318A03431, n°10 inserts, n°2 nut plates and the rework of the FWD panel assy P/N 3G5315A51631. The audio customization upgrade Dubai AW P/N 3G2350P04911 consist of the modify of some wiring and the installation of the HI Z4 place intercom with trasmit P/N AA38-603, the audio connector assy P/N 3G2350A10231, C/A A1A682, C/A A2A619, C/A B1L120, C/A B2B746, C/A B2L115 and relevant fixing hardware.

The 12VDC 5AMP max utility sockets structural provision P/N 3G5311A41011 consist of the installation of the 12VDC 5 AMP sockets support assy P/N 3G5318A03131, relevant fixing hardware and n°4 inserts P/N NAS1835-08. The 12VDC 5AMP max utility sockets elect installation P/N 3G2460A04811 consist of the installation of the power converter P/N LT-71, C/A B1L121, C/A B1R19 and relevant fixing hardware.

The cabin liners retromod for D.A.W. (fiber) P/N 3G2580P21111 consist of the rework of the window LWR liner LH P/N 3G2580P04332 and the upper liner P/N 3G2580A68331 and the installation of the cable cover assy LH and RH, the cover for flashlight P/N 3G2580A79951 and n°2 headphone jack sockets.

The MLT cabin control panel (MCCP) elect prov P/N 3G4620A00611 consist of the installation of the mission bus RH structural provision P/N 3G5310A63413, n°3 circuit breakers, C/A B1B167, C/A B1B168, C/A E1C243 and relevant fixing hardware.

The AUX O/H PNL retromod P/N 3G2460P01026 consist of the replacement of the integrally light AUX breaker panel P/N 3G2490L04159 with the P/N 3G2490L05769 and the integrally light switch panel P/N 3G2490V00958 with the P/N 3G2491L00162 and of the modification of some electrical wires involves in the replacement.

F. APPROVAL

The technical content of this Service Bulletin is approved under the authority of DOA nr. EASA.21.J.005. For helicopters registered under other Aviation Authorities, before applying the Service Bulletin, applicable Aviation Authority approval must be checked within Leonardo Helicopters customer portal.

EASA states mandatory compliance with inspections, modifications or technical directives and related time of compliance by means of relevant Airworthiness Directives. If an aircraft listed in the effectivity embodies a modification or repair not LHD certified and affecting the content of this Service Bulletin, it is responsibility of the Owner/Operator to obtain a formal approval by Aviation Authority having jurisdiction on the aircraft, for any adaptation necessary before incorporation of the present Service Bulletin.

G. MANPOWER

To comply with this Service Bulletin three hundred eighty (380) MMH are deemed necessary.

MMH are based on hands-on time and can change with personnel and facilities available.

H. WEIGHT AND BALANCE

WEIGHT (Kg)	ARM (mm)	MOMENT (Kgmm)
		10,2
LONGITUDINAL BALANCE	3943	40061,64
LATERAL BALANCE	-61	-616,91

I. REFERENCES

1) PUBLICATIONS

<u>DATA MODULE</u>	<u>DESCRIPTION</u>	<u>PART</u>
DM01 39-A-00-20-00-00A-120A-A	Helicopter on ground for a safe maintenance	-
DM02 39-A-06-41-00-00A-010A-A	Access doors and panels – General data.	-
DM03 39-A-23-57-01-00A-720A-A	Cabin station 4 audio panel – Install procedure	-
DM04 39-A-11-00-01-00A-720A-A	Decal - Install procedure	-
DM05 39-A-20-10-18-00A-691A-A	Electrical wires and cables – Marking	-
DM06 39-A-20-10-08-00A-622A-A	Electrical contacts - Crimp	-
DM07 39-A-20-00-00-00A-711A-A	Threaded fasteners - Tighten procedure	-
DM08 39-A-46-20-00-00A-750A-A	Processing and integrating - Optio and setting file - Load software procedure	-

2) ACRONYMS & ABBREVIATIONS

AMDI	Aircraft Material Data Information
AMP	Aircraft Maintenance Publication
AR	As Required
CB	Circuit Breaker
DM	Data Module
DOA	Design Organization Approval
EASA	European Aviation Safety Agency
ICS	Intercommunication System
LHD	Leonardo Helicopters Division
LH	Left Hand
MMH	Maintenance-Man-Hours
RH	Right Hand

3) ANNEX

Annex A - 3G2350P04911 (DAW upgrade) system test procedure

Annex B - cabin AV900 acceptance test procedure

Annex C - AW139 rescue hoist system Breeze 90 meters ATP

J. PUBLICATIONS AFFECTED

N.A.

K. SOFTWARE ACCOMPLISHMENT SUMMARY

Software to be updated:

Option file P/N DM60004869-60629.

2. MATERIAL INFORMATION

A. REQUIRED MATERIALS

1) PARTS

#	P/N	ALTERNATIVE P/N	DESCRIPTION	Q.TY	LVL	NOTE	LOG P/N
1	4G2350F00914		KIT ICS AV900 CAB STATION 4	REF	.		-
2	4G2350A03211		ICS AV900 CABIN STATION 4 ELEC INSTL	REF	..		-
3	7511900-99002	7511900-99202	AV900 audio panel block 3	1	...	(1) (2)	-
4	ED300A189		Decal	1	...		139-564L1
5	4G2350A03313		ICS AV900 CABIN STATION 4 COMPLETE	REF	..		-
6	4G2350A03412		ICS AV900 CABIN STATION 4 ELEC PROV	REF	...		-
7	3G9A01A31201	4G2350A03412A1R	ICS cabin station 4 C/A (A1A312)	REF		-
8	3G9A02A28901		ICS cabin station 4 C/A (A2A289)	REF		-
9	3G9A02B29801	3G9A02B29801A10R	ICS cabin station 4 C/A (A2B298)	1		139-564L1
10	3G9B01A43301	4G2350A03412A11R	ICS cabin station 4 C/A (B1A433)	1		139-564L1
11	3G9B02A29901		ICS cabin station 4 C/A (B2A299)	1		139-564L1
12	3G9B02A30101		ICS cabin station 4 C/A (B2A301)	1		139-564L1
13	3G9B02B31901	4G2350A03412A12R	ICS cabin station 4 C/A (B2B319)	1		139-564L1
14	3G9B02B31701		ICS cabin station 4 C/A (B2B317)	1		139-564L1
15	A366A3E12C75		Stud	1		139-564L1
16	A366A3E32C		Stud	1		139-564L1
17	A522A02A		Mounting rail	1		139-564L1
18	A524A1A-A		Identification plate	1		139-564L1
19	A524A2A-A		Identification plate	1		139-564L1
20	A593A-A02		Terminal board	1		139-564L1
21	A593A-B03		Terminal board	1		139-564L1
22	AW001CB03H		Clamp	8		139-564L1
23	AW001CB08H		Clamp	6		139-564L1
24	AW001CB13H		Clamp	3		139-564L1
25	AW001CL000A-X3		Support	5		139-564L1
26	ED300TB277		Decal	1		139-564L1
27	MS21042L3		Nut	3		139-564L1
28	MS9592-014		Bracket	1		139-564L1
29	NAS1149D0332J		Washer	5		139-564L1
30	NAS1149DN816J		Washer	2		139-564L1
31	NAS1802-08-7		Screw	2		139-564L1
32	NAS1802-3-14		Screw	1		139-564L1
33	NAS1802-3-26		Screw	5		139-564L1
34	NAS1802-3-28		Screw	1		139-564L1
35	NAS1802-3-9		Screw	1		139-564L1
36	NAS43DD3-110N		Spacer	1		139-564L1
37	NAS43DD3-16N		Spacer	1		139-564L1
38	NAS43DD3-20N		Spacer	1		139-564L1
39	NAS43DD3-65N		Spacer	1		139-564L1

#	P/N	ALTERNATIVE P/N	DESCRIPTION	Q.TY	LVL	NOTE	LOG P/N
40	NAS43DD3-75N		Spacer	5	...		139-564L1
41	M39029/56-348		Electrical contact	2	...		139-564L1
42	M39029/58-360		Electrical contact	1	...		139-564L1
43	A523A-A01		Electrical contact	5	...		139-564L1
44	A523A-A03		Electrical contact	1	...		139-564L1
45	A523A-A05		Electrical contact	4	...		139-564L1
46	M39029/56-351		Electrical contact	10	...		139-564L1
47	M39029/58-363		Electrical contact	13	...		139-564L1
48	A523A-A02		Electrical contact	1	...		139-564L1
49	3G5311A41211		AUDIO CUST UPGRADE DUBAI STRUC PROV	REF	.		-
50	3G5317A88151		Bracket	1	..		139-564L1
51	3G5318A03431		Support assy	1	..		139-564L1
52	3G5318A03651		Spacer	2	..		139-564L1
53	A813A08CM		Insert	4	..		139-564L1
54	MS20426AD3-7		Rivet	0.1 kg	..		139-564L1
55	MS21069L06		Nut plate	2	..		139-564L1
56	MS27039-1-05		Screw	8	..		139-564L1
57	MS27039-1-07		Screw	4	..		139-564L1
58	NAS1149D0316K		Washer	8	..		139-564L1
59	NAS1835-3		Insert	8	..		139-564L1
60	NAS1836-06-13		Insert	2	..		139-564L1
61	3G5315P05531		FWD PANEL ASSY REWORKED	REF	..	(3)	-
62	3G2350P04911		AUDIO CUSTOMIZATION UPGRADE DUBAI AW	REF	.		-
63	3G2350A10231		Audio connector assy	1	..		139-564L1
64	3G9A01A68201	3G2350P04911A1R	Audio customization upgrade C/A (A1A682)	1	..	(8)	139-564L1
65	3G9A02A61901	3G2350P04911A1R	Audio customization upgrade C/A (A2A619)	1	..	(9)	139-564L1
66	3G9B01L12001	3G2350P04911A2R	Audio customization upgrade C/A (B1L120)	1	..	(10)	139-564L1
67	3G9B02L11501	3G2350P04911A2R	Audio customization upgrade C/A (B2L115)	1	..	(11)	139-564L1
68	3G9B02B74601		Audio customization upgrade C/A (B2B746)	1	..		139-564L1
69	M39029/56-348		Electrical contact	2	..		139-564L1
70	M39029/56-351		Electrical contact	2	..		139-564L1
71	A363A01		Terminal stud assy	1	..		139-564L1
72	ED300GS2103		Decal	1	..		139-564L1
73	A366A3E16C		Stud	1	..		139-564L1
74	A366A3E22C		Stud	1	..		139-564L1
75	A366A3E32C		Stud	2	..		139-564L1
76	A522A02A		Mounting rail	1	..		139-564L1
77	A524A1A-A		Identification plate	1	..		139-564L1
78	A593A-A06		Terminal Board	1	..		139-564L1
79	AA38-603		HI Z4 place intercom with trasmit	1	..		139-564L1
80	AW001CB03H		Clamp	2	..		139-564L1
81	AW001CB04H		Clamp	1	..		139-564L1
82	AW001CB05H		Clamp	1	..		139-564L1
83	AW001CB06H		Clamp	1	..		139-564L1
84	AW001CB07H		Clamp	1	..		139-564L1
85	AW001CB10H		Clamp	1	..		139-564L1
86	AW001CB17H		Clamp	1	..		139-564L1
87	AW001CL000A-X3		Support	1	..		139-564L1

#	P/N	ALTERNATIVE P/N	DESCRIPTION	Q.TY	LVL	NOTE	LOG P/N
88	AW001CL001-N6		Support	4	..		139-564L1
89	ED300A670		Decal	1	..		139-564L1
90	ED300HT128J1		Decal	1	..		139-564L1
91	ED300HT129J1		Decal	1	..		139-564L1
92	ED300J2441		Decal	1	..		139-564L1
93	ED300J2443		Decal	1	..		139-564L1
94	ED300K429		Decal	1	..		139-564L1
95	ED300PAX		Decal	1	..		139-564L1
96	ED300RADIO;ICS		Decal	2	..		139-564L1
97	ED300S408		Decal	1	..		139-564L1
98	ED300S409		Decal	1	..		139-564L1
99	ED300TB2297		Decal	1	..		139-564L1
100	LED-6A-45-KA-38735		Switch	2	..		139-564L1
101	M83536/26-002L		Relay	1	..		139-564L1
102	M85049/95-12A-A		Connector mounting device	2	..		139-564L1
103	MS21043L3	MS21043-3	Nut	3	..		139-564L1
104	MS3181-12CA		Dust	2	..		139-564L1
105	NAS1149D0332J		Washer	7	..		139-564L1
106	NAS1149DN416J		Washer	8	..		139-564L1
107	NAS1149DN616J		Washer	2	..		139-564L1
108	NAS1802-04-6		Screw	8	..		139-564L1
109	NAS1802-06-7		Screw	2	..		139-564L1
110	NAS43DD3-19N		Spacer	1	..		139-564L1
111	NAS43DD3-35N		Spacer	1	..		139-564L1
112	NAS43DD3-40N		Spacer	1	..		139-564L1
113	NAS43DD3-45N		Spacer	1	..		139-564L1
114	NAS43DD3-50N		Spacer	1	..		139-564L1
115	NAS1802-3-9		Screw	4	..		139-564L1
116	3G5311A41011		12VDC 5AMP MAX UTILITY SCKTS STRUC PROV	REF	.		-
117	3G5315P05431		FWD PANEL ASSY REWORKED	REF	..	(3)	-
118	NAS1836-08-13		Insert	6	...		139-564L1
119	3G5318A03131		12VDC 5 AMP sockets support assy	1	..		139-564L1
120	MS27039-0805		Screw	6	..		139-564L1
121	NAS1149DN816K		Washer	6	..		139-564L1
122	NAS1835-08		Insert	4	..		139-564L1
123	3G2460A04811		12VDC 5AMP MAX UTILITY SCKTS ELECT INSTL	REF	.		-
124	3G2460A03231		28VDC/20A utility socket assy	2	..		139-564L1
125	3G9B01L12101	3G2460A04811A1R	12VDC 5AMP max utility sckts (B1L121)	1	..		139-564L1
126	3G9B01R01901		12VDC 5AMP max utility sckts (B1R19)	1	..		139-564L1
127	A236A02AB85	A236A02AB	Nonmetallic channel	1,2 m	..		139-564L1
128	A363A01		Terminal stud assy	1	..		139-564L1
129	A366A3E16C		Stud	1	..		139-564L1
130	A366A3E22C		Stud	2	..		139-564L1
131	A608A01		Plate	1	..		139-564L1
132	AW001CB03H		Clamp	2	..		139-564L1
133	AW001CB04H		Clamp	1	..		139-564L1
134	AW001CL001-N6		Support	4	..		139-564L1
135	AW001CL005A01-X1		Support	1	..		139-564L1

#	P/N	ALTERNATIVE P/N	DESCRIPTION	Q.TY	LVL	NOTE	LOG P/N
136	ED30012VDC		Decal	2	..		139-564L1
137	ED3005A;MAX		Decal	2	..		139-564L1
138	ED300GS2105		Decal	1	..		139-564L1
139	ED300PS108		Decal	1	..		139-564L1
140	LT-71		Power Converter (28/14VDC-8A)	1	..		139-564L1
141	MS21042L3		Nut	3	..		139-564L1
142	NAS1149D0332J		Washer	7	..		139-564L1
143	NAS1802-3-7		Screw	4	..		139-564L1
144	NAS43DD3-35N		Spacer	1	..		139-564L1
145	NAS43DD3-55N		Spacer	2	..		139-564L1
146	MS25036-103		Terminal lug	1	.		139-564L1
147	M39029/58-364		Electrical contact	1	.		139-564L1
148	3G4620A00611		MLT CABIN CTL PNLs (MCCP) ELECT PROV	REF	.		-
149	1035685-22		Bus bar	1	..		139-564L1
150	3G2490L04058		Illuminated NVIS panel utility	1	..		139-564L1
151	3G5310A63413		MISSION BUS RH STRUCTURAL PROVISION	REF	..		-
152	3G5315A68151		Bracket	1	...		139-564L1
153	NAS9301B-4-02		Rivet	3	...		139-564L1
154	3G9B11B16712		Utility CB panel RH C/A (B1B167)	1	..	(4)	139-564L1
155	3G9B11B16814		Utility CB panel RH C/A (B1B168)	1	..	(5)	139-564L1
156	3G9E01C24330		Utility CB panel RH C/A (E1C243)	REF	..		-
157	A556A-T18		Wire	2.5 m	.		139-564L1
158	A556A-T20		Wire	1.5 m	.		139-564L1
159	M39029/56-351		Electrical contact	1	.		139-564L1
160	M39029/56-352		Electrical contact	1	.		139-564L1
161	MS25036-149		Terminal lug	2	.		139-564L1
162	A584A02		Nipple	2	..		139-564L1
163	AW001CB02H		Clamp	2	..		139-564L1
164	AW001CB05H		Clamp	1	..		139-564L1
165	AW001YC01RED		Circuit breaker locking ring	3	..		139-564L1
166	ED300CB377		Decal	1	..		139-564L1
167	ED300CB646		Decal	1	..		139-564L1
168	ED300CB647		Decal	1	..		139-564L1
169	MS21043-3		Nut	1	..		139-564L1
170	MS25244-50	30-072-1	Circuit breaker	1	..		139-564L1
171	MS3320-7-1/2		Circuit breaker	2	..		139-564L1
172	MS35338-138		Washer	1	..		139-564L1
173	NAS1149D0332J		Washer	1	..		139-564L1
174	NAS1149D0332K		Washer	1	..		139-564L1
175	NAS1190E3P14AK		Screw	1	..		139-564L1
176	NAS43DD3-25N		Spacer	2	..		139-564L1
177	NAS43DD3-30N		Spacer	1	..		139-564L1
178	A366A3E16C		Stud	1	..		139-564L1
179	NAS1802-3-7		Screw	1	..		139-564L1
180	NAS1802-3-12		Screw	1	..		139-564L1
181	MS25036-116		Terminal lug	1	..		139-564L1
182	MS25036-115		Terminal lug	2	..		139-564L1
183	DM60004869-60629		Option file	1	.		139-564L1
184	3G2580P21111		CABIN LINERS RETROMOD FOR D.A.W. (FIBER)	REF	.		-

#	P/N	ALTERNATIVE P/N	DESCRIPTION	Q.TY	LVL	NOTE	LOG P/N
185	3G2580A78231		Cable cover assy RH	1	..		139-564L1
186	3G2580A78331		Cable cover assy LH	1	..		139-564L1
187	3G2580A78451		Cover	1	..		139-564L1
188	3G2580A78551		Frame	1	..		139-564L1
189	3G2580A78651		Honeycomb	5	..		139-564L1
190	3G2580A79911		COVER INSTL FOR FLASH NC LIGHT	REF	..		-
191	3G2580A79951	3G2580A79951A1	Cover for flashlight	1	...		139-564L1
192	MS35214-40		Screw	4	...		139-564L1
193	NAS1835-08		Insert	4	...		139-564L1
194	3G2580P10731		Window liner assy lower reworked LH	REF	..	(6)	-
195	3G5317A77455		Headphone jack socket	1	..		139-564L1
196	3G5317A77454		Headphone jack socket	1	..		139-564L1
197	A196A500B		Plug	1	..		139-564L1
198	A350A-F009	A350A-F	Receptacle	1 m	..		139-564L1
199	A407A08C1P		Anchor Nut	4	..		139-564L1
200	AN525-832R9		Screw	4	..		139-564L1
201	MS35206-227		Screw	4	..		139-564L1
202	NAS620-6L		Washer	4	..		139-564L1
203	NAS9303B-4-02		Rivet	1	..		139-564L1
204	NAS1097AD4-7		Rivet	0,1 kg	..		139-564L1
205	3G2350P06411		PTT HOIST & AUDIO CUSTOMIZATION UPGRADE	REF	.		-
206	3G9B01L20901		PTT HOIST & AUDIO CUNTOT C/A (B1L209)	REF	..		-
207	AW001CL001-N6		Support	1	...		139-564L1
208	350690-3		Electrical contact	1	...		139-564L1
209	A523A-A02		Electrical contact	2	...		139-564L1
210	A556A-T22		Wire	4m	...		139-564L1
211	BJE86		Fuse link	1	...		139-564L1
212	M39029/56-348		Electrical contact	1	...		139-564L1
213	3G9B01R09701		PTT HOIST & AUDIO CUNTOT C/A (B1R097)	REF	..		-
214	A574A01-03		Insulation sleeving	1	...		139-564L1
215	A574A04-01		Insulation sleeving	2	...		139-564L1
216	A523A-A02		Electrical contact	4	...		139-564L1
217	A556A-T20		Wire	2m	...		139-564L1
218	A556A-T22		Wire	6.5m	...		139-564L1
219	AW001YD03		Diode	2	...		139-564L1
220	M39029/56-348		Electrical contact	3	...		139-564L1
221	M39029/56-351		Electrical contact	1	...		139-564L1
222	M81824/1-1		Splice	1	...		139-564L1
223	3G2460P01026		AUX O/H PNL RETROMOD	REF	.		-
224	ED300S137		Decal	1	..		139-564L1
225	ED300S352		Decal	1	..		139-564L1
226	3G2490L05769		Integrally light AUX breaker panel	1	..		139-564L1
227	3G2491L00162		Integrally light switch panel	1	..		139-564L1
228	AS44417-B12		Plug	1	..		139-564L1
229	3G9E01C30007		AUX CB PNL VARIANT C/A (E1C300)	REF	.		-
230	M39029/1-102		Electrical contact	2	..		139-564L1
231	M39029/56-351		Electrical contact	3	..		139-564L1
232	M39029/56-352		Electrical contact	1	..		139-564L1
233	MS25036-149		Electrical contact	1	..		139-564L1

#	P/N	ALTERNATIVE P/N	DESCRIPTION	Q.TY	LVL	NOTE	LOG P/N
234	A556A-T20		Electrical wire	3.0 m	..		139-564L1
235	MS25036-153		Electrical contact	1	.		139-564L1
236	A583A2610W		Cap	2	.		139-564L1
237	MS20426AD3-7		Rivet	0,1 kg	.		139-564L1
238	MS21069L08		Nut	2	.		139-564L1

2) CONSUMABLES

The following consumable materials, or equivalent, are necessary to accomplish this Service Bulletin:

#	Spec./LHD code number	DESCRIPTION	Q.TY	NOTE	PART
239	AWTR033	Fiberglass (C932)	AR	(7)	-
240	199-50-002 TY I Code No. 900001557	Araldit LY5138-2	AR	(7)	-
241	199-05-002 TY II, CL 2 Code No. 900004603 MMM-A-132, Type 1, Class 3	Adhesive Epoxy EA934NA (C057)	AR	(7)	-
242	A236A01AB	Edging	AR	(7)	-
243	A582A08 or EN6049-006-08-5	Tubing braided	AR	(7)	-
244	AWMS44-0 TY B, CL B	Fiberglass	AR	(7)	-
245	Commercial	Fabric, Fiberglass	AR	(7)	-
246	199-50-002 TY II Code No. 900001558	Amine hardener HY5173	AR	(7)	-
247	199-05-002 TY I, CL 2 Code no. 900000581 (MMM-A-132)	Adhesive EA9309.3NA (C021)	AR	(7)	-
248	A236A02AB	Nonmetallic channel	AR	(7)	-
249	A305A25B1Y	Velcro hook	AR	(7)	-

Refer also to AMDI for the consumable materials required to comply with the AMP DM referenced in the accomplishment instructions.

3) LOGISTIC MATRIX

In order to apply this Service Bulletin, the following Logistic P/N can be ordered in accordance with the applicable notes:

LOGISTIC P/N	Q.TY (PER HELO)	NOTE	PART
139-564L1	1	-	-
7511900-99002	1	(1)	-
7511900-99202	1	(2)	-

NOTES

- (1) P/N 7511900-99002 is applicable only for helicopter NOT in NVG configuration.
- (2) P/N 7511900-99202 is applicable only for helicopter with NVG.
- (3) This item is obtained from the rework of the FWD panel assy P/N 3G5315A51631 already installed on the helicopter.
- (4) This item is composed of utility CB panel C/A P/N 3G9B01B39922 (B1B399), marker sleeves P/N A578A06-9 and meta-aramid P/N MDS/N1335V.
- (5) This item is composed of utility CB panel C/A P/N 3G9B01B40129 (B1B401), marker

sleeves P/N A578A06-9 and meta-aramid P/N MDS/N1335V.

(6) This item is obtained from the rework of the window LWR liner LH P/N 3G2580P04332 already installed on the helicopter.

(7) Item to be procured as local supply.

(8) The C/A P/N 3G9A01A68201 (A1A682) can be provided as loose items not assembled. Below, the list of the parts:

P/N	DESCRIPTION	Q.TY
A556A-T20	Wire	4 m
A523A-A02	Electrical contact	2
M39029/58-363	Electrical contact	2

(9) The C/A P/N 3G9A02A61901 (A2A619) can be provided as loose items not assembled. Below, the list of the parts:

P/N	DESCRIPTION	Q.TY
A556A-T22	Wire	2.5 m
M39029/56-348	Electrical contact	1
M39029/58-360	Electrical contact	1

(10)The C/A P/N 3G9B01L12001 (B1L120) can be provided as loose items not assembled. Below, the list of the parts:

P/N	DESCRIPTION	Q.TY
A556A-T20	Wire	14 m
A556A-T22	Wire	1 m
A556A-T24	Wire	25 m
18-240	Connector	2
A523A-A01	Electrical contact	3
A523A-A02	Electrical contact	1
A523A-A05	Electrical contact	1
D37000GVL0	Backshell	2
FC7520D	Electrical contact	5
M12883/47-10S	Socket relay	1
M39029/22-192	Electrical contact	18
M39029/5-116	Electrical contact	2
M39029/56-351	Electrical contact	1
M39029/58-363	Electrical contact	1
M81824/1-1	Splice	7
M81824/1-2	Splice	3
MS25036-103	Terminal lug	1
SD37F10GVL0	Connector	2

(11)The C/A P/N 3G9B02L11501 (B2L115) can be provided as loose items not assembled. Below, the list of the parts:

P/N	DESCRIPTION	Q.TY
A556A-T22	Wire	15 m
A556A-T24	Wire	60 m
A561A-T2-22	Wire	25 m
A561A-T2-24	Wire	50 m

350690-3	Electrical contact	4
350781-1	Connector	1
A523A-A01	Electrical contact	9
A523A-A02	Electrical contact	8
A523A-A05	Electrical contact	2
A532A300-1203C	Adapter	1
A590A02	Ferule	18
AW001YD12	Diode assembly	4
FC7520D	Electrical contact	42
M23053/8-004-C	Insulation sleeve	0.5 m
M39029/22-192	Electrical contact	6
M39029/5-115	Electrical contact	12
M39029/5-117	Electrical contact	10
M39029/56-348	Electrical contact	1
M39029/57-354	Electrical contact	4
M39029/57-357	Electrical contact	9
M39029/58-363	Electrical contact	2
M81824/1-1	Splice	8
MS25036-148	Terminal lug	1
MS3470L12-10S	Connector	2

B. SPECIAL TOOLS

The following special tools, or equivalent, are necessary to accomplish this Service Bulletin:

#	P/N	DESCRIPTION	Q.TY	NOTE	PART
250	3G2350G00131	Testing Audio Cable	1	(B1)	-

Refer also to Annex A, Annex B for the special tools required to comply with the annexes and to ITEP for the special tools required to comply with the AMP DM referenced in the accomplishment instructions.

SPECIAL TOOLS NOTE

(B1) Tool P/N 3G2350G00131 can be used as a valid alternative to P/N TME392350AA00 required in Annex A.

C. INDUSTRY SUPPORT INFORMATION

Customization

3. ACCOMPLISHMENT INSTRUCTIONS

GENERAL NOTES

- a) Place an identification tag on all components that are re-usable, including the attaching hardware that has been removed to gain access to the modification area and adequately protect them until their later re-use.
 - b) Exercise extreme care during drilling operations to prevent instruments, cables and hoses damage.
 - c) After drilling, remove all swarf and sharp edges. Apply on bare metal a light film of primer unless the hole is used for ground connection.
 - d) Shape the cables in order to prevent interference with the structure and the other existing installations, using where necessary suitable lacing cords.
 - e) During the installation of bonding braids or components requiring grounding, clean the surface structure in order to obtain a good ground contact.
 - f) Protect properly all those equipment not removed from area affected by the modification during installation procedure.
 - g) Let the adhesive cure at room temperature for at least 24 hours, unless otherwise specified.
 - h) All lengths are in mm.
 - i) To ensure proper installation, it is allowed to use clamps larger than the nominal one.
-
1. In accordance with AMP DM 39-A-00-20-00-00A-120A-A prepare the helicopter on ground for a safe maintenance. Disconnect the battery, all electrical power sources and/or the external power supply.
 2. In accordance with AMP DM 39-A-06-41-00-00A-010A-A and with reference to Figures 41 thru 47, gain access to the area affected by the installation and perform the cabin liners retromod for D.A.W. (fiber) P/N 3G2580P21111 as described in the following procedure:
 - 2.1 With reference to Figure 47, perform the cover installation for flashlight P/N 3G2580A79911 as described in the following procedure:

- 2.1.1 With reference to Figure 47 View A-A, temporarily locate the cover for flashlight P/N 3G2580A79951 in its position on the limo window.
 - 2.1.2 With reference to Figure 47 Detail B, drill n°4 holes $\varnothing 17.42 \div 17.55$ thru the limo window in accordance with the cover for flashlight P/N 3G2580A79951 and the dimensioning shown.
 - 2.1.3 With reference to Figure 47 Detail B, install n°4 inserts P/N NAS1835-08 on the limo window by means of adhesive EA934NA (C057).
- NOTE**
- During the installation, it is admitted to trim the cover for flashlight P/N 3G2580A79951 in accordance with the existing velcro on limo window.
- 2.1.4 With reference to Figure 47 View A-A and Section C-C, install the cover for flashlight P/N 3G2580A79951 on the limo window by means of n°4 screws P/N MS35214-40.
 - 2.1.5 With reference to Figure 47 View A-A, paint the external finishing in view of the cover for flashlight P/N 3G2580A79951 by means of black matt paint in accordance with the limo window finishing.
- 2.2 With reference to Figure 41 View C, install the cable cover assy LH P/N 3G2580A78331 by means of n°2 screws P/N MS35206-227 and n°2 washers P/N NAS620-6L.
 - 2.3 With reference to Figure 42 View E, repeat step 2.2 for the cable cover assy RH P/N 3G2580A78231.
 - 2.4 With reference to Figure 42 Isoviev, remove the window LWR liner LH P/N 3G2580P04332.
 - 2.5 With reference to Figures 42 and 43, perform the rework of the window LWR liner LH P/N 3G2580P04332 as described in the following procedure:
 - 2.5.1 With reference to Figure 43 Detail F, remove the dzus receptacle P/N A350A-F007 from the window LWR liner LH P/N 3G2580P04332 and retain for later reuse.
 - 2.5.2 With reference to Figure 43 Detail F, perform the indicated cut-out of the window LWR liner LH P/N 3G2580P04332 in accordance with the dimensioning shown.
 - 2.5.3 With reference to Figure 43 Detail F and View D, install the dzus receptacle P/N A350A-F009 on the window LWR liner LH P/N 3G2580P04332 by means of n°10 rivets P/N NAS1097AD4.

- 2.5.4 With reference to Figure 43 View D and Detail G, perform the indicated cut-out of the window LWR liner LH P/N 3G2580P04332 in accordance with the dimensioning shown.
- 2.5.5 With reference to Figure 43 Detail G and View D, install the dzus receptacle P/N A350A-F007 previously removed on the window LWR liner LH P/N 3G2580P04332 by means of n°10 rivets P/N NAS1097AD4.

NOTE

Flare the existing hole 100 DEG x 0.7.

- 2.5.6 With reference to Figure 43 View D, close the existing hole on the window LWR liner LH P/N 3G2580P04332 by means of the rivet P/N NAS9303B-4-02.
- 2.5.7 With reference to Figure 43 View D, close the existing hole on the window LWR liner LH P/N 3G2580P04332 by means of the plug P/N A196A500B.
- 2.5.8 With reference to Figure 43 View D, remark the window LWR liner LH P/N 3G2580P04332 as the window LWR liner LH P/N 3G2580P10731.
- 2.6 With reference to Figure 44 View A, remove the headphone jack socket P/N 3G5317A77452 from the liner assy ceiling central reworked P/N 3G2580P10131 and retain existing fixing hardware.
- 2.7 With reference to Figure 44 View A, install the headphone jack socket P/N 3G5317A77454 on the liner assy ceiling central reworked P/N 3G2580P10131 by means of existing hardware previously removed.
- 2.8 With reference to Figure 44 View A, remove the headphone jack socket P/N 3G5315A82953 from the liner assy ceiling central reworked P/N 3G2580P10131 and retain existing fixing hardware.
- 2.9 With reference to Figure 44 View A, install the headphone jack socket P/N 3G5317A77455 on the liner assy ceiling central reworked P/N 3G2580P10131 by means of existing hardware previously removed.
- 2.10 With reference to Figure 45 View H, perform the indicated cut-out thru the upper liner P/N 3G2580A68331 in accordance with the dimensioning shown.
- 2.11 With reference to Figure 45 View H and Figure 46 Schematic Section K-K, apply and bond n°5 honeycombs P/N 3G2580A78651 on the upper liner P/N 3G2580A68331 in the indicated positions by means of adhesive EA9309.3NA (C021).
- 2.12 With reference to Figure 45 View H and Figure 46 Schematic Section K-K, apply

n°2 plies of fiberglass commercial and n°2 plies of fiberglass AWMS44-004 Type B Class B for each honeycomb P/N 3G2580A78651 in accordance with the dimensioning shown. Impregnate the layers by means of Araldit LY5138-2 and Amine hardener HY5173.

- 2.13 With reference to Figure 45 View B-B, temporarily locate the cover P/N3G2580A78451 on the upper liner assy P/N 3G2580A68231.
- 2.14 With reference to Figure 45 View H, drill n°4 holes $\varnothing 5.16 \div 5.28$ thru the upper liner P/N 3G2580A68331 in accordance with the dimensioning shown and the cover P/N 3G2580A78451.
- 2.15 With reference to Figure 45 View J, install n°4 anchor nuts P/N A407A08C1P on the upper liner P/N 3G2580A68331 in accordance with the dimensioning shown by means of adhesive EA9309.3NA (C021).
- 2.16 With reference to Figure 46 View J, install the velcro hook P/N A305A25B1Y on the previously installed honeycombs P/N 3G2580A78651.
- 2.17 With reference to Figure 46 View J and Section L-L, install the frame P/N 3G2580A78551 inside the performed cut-out by means of adhesive EA934NA (C057).
- 2.18 With reference to Figure 46 Section L-L, apply the nonmetallic channel P/N A236A02AB above the frame edge P/N 3G2580A78551.
- 2.19 With reference to Figure 45 View B-B, install the cover P/N 3G2580A78451 on the performed cut-out on the upper liner assy P/N 3G2580A68231 by means of n°4 screws P/N AN525-832R9.

NOTE

In order to avoid any interferences with other fixings the site of the drilling can be slightly moved.

- 2.20 With reference to Figure 57 Detail A and Section B-B, drill n°2 holes $\varnothing 4.36 \div 4.49$ thru the structure P/N 2P5335A10752 in accordance with the dimensioning shown.
 - 2.21 With reference to Figure 57 Section B-B, install n°2 anchor nuts P/N MS21069L08 on the structure P/N 2P5335A10752 by means of n°4 rivets P/N MS20426AD3.
3. In accordance with AMP DM 39-A-06-41-00-00A-010A-A and with reference to Figures 1 thru 5, gain access to the area affected by the installation and perform audio cust upgrade dubai struct prov P/N 3G5311A41211 as described in the following procedure:

NOTE

Perform step 3.1 thru step 3.4 only if the lower panel assy avionic bay P/N 3G5315A43431 is installed on configuration, otherwise skip at step 3.5.

- 3.1 With reference to Figure 2 Detail C, drill n°8 insert holes $\varnothing 17.42 \pm 17.55$ thru the lower panel assy avionic bay P/N 3G5315A43431 in accordance with the dimensioning shown.

NOTE

Prepare the surface shown on figure for electrical bonding.

- 3.2 With reference to Figure 2 Detail C, install n°8 inserts P/N NAS1835-3 on the lower panel assy avionic bay P/N 3G5315A43431 by means of adhesive EA934NA (C057).
- 3.3 With reference to Figure 1 Section A-A, install the bracket P/N 3G5317A88151 on the lower panel assy avionic bay P/N 3G5315A43431 by means of n°4 screws P/N MS27039-1-05 and n°4 washers P/N NAS1149D0316K.
- 3.4 With reference to Figure 1 Section A-A, install the support assy P/N 3G5318A03431 on the lower panel assy avionic bay P/N 3G5315A43431 by means of n°4 screws P/N MS27039-1-05 and n°4 washers P/N NAS1149D0316K.

NOTE

Perform step 3.5 and step 3.6 only if the under tank panel P/N 3G5338A06632 is installed on configuration, otherwise skip at step 3.7.

- 3.5 Repeat step 3.1 thru step 3.3 for the under tank panel P/N 3G5338A06632.
- 3.6 With reference to Figure 1 Section A-A, install the support assy P/N 3G5318A03431 on the under tank panel P/N 3G5338A06632 by means of n°4 screws P/N MS27039-1-07, n°4 washers P/N NAS1149D0316K and n°2 spacers P/N 3G5318A03651.
- 3.7 With reference to Figure 2 Section D-D and Figure 4 Section L-L, drill n°2 insert holes $\varnothing 17.42 \pm 17.55$ thru the panel P/N 3G5333A10231 in accordance with the dimensioning shown.
- 3.8 With reference to Figure 4 Section L-L, install n°2 inserts P/N NAS1836-06-13 on the panel P/N 3G5333A10231 by means of adhesive EA934NA (C057).
- 3.9 With reference to Figure 2 Section D-D, perform the indicated cut-out on the lower panel P/N 3G5333A10231.
- 3.10 With reference to Figure 3 Section F-F, fill the honeycomb with adhesive EA934NA (C057) and apply n°2 plies of fiberglass C932 on the cutout edges of the lower panel P/N 3G5333A10231 by means of the resin Araldit LY5138-2.
- 3.11 With reference to Figure 3 Detail E and Section G-G, drill n°2 holes $\varnothing 3.68 \pm 3.81$

thru the structure P/N 3P5333A01031.

NOTE

Prepare the surface shown on figure for electrical bonding.

- 3.12 With reference to Figure 3 Detail E and Section G-G, install n° 2 nut plates P/N MS21069L06 on the structure P/N 3P5333A01031 by means of n°4 rivets P/N MS20426AD3-7.
- 3.13 With reference to Figure 4 Detail H and Section M-M, drill n°4 insert holes $\varnothing 14.25 \div 14.38$ thru the left side wall assy P/N 3P5335A00134.
- 3.14 With reference to Figure 4 Detail H and Section M-M, install n°4 inserts P/N A813A08CM on the left side wall assy P/N 3P5335A00134 by means of adhesive EA934NA (C057).
- 3.15 With reference to Figures 1 and 5, perform the FWD panel assy reworked P/N 3G5315P05531 and the FWD panel assy reworked P/N 3G5315P05431 as described in the following procedure:
 - 3.15.1 With reference to Figure 1 View B, remove the FWD panel assy P/N 3G5315A51631 from the helicopter.
 - 3.15.2 With reference to Figure 5 Detail N and Section P-P, perform the indicated cut-out and fill the cut-out edges all around with adhesive EA934NA (C057).
 - 3.15.3 With reference to Figure 5 Detail N and Section Q-Q, perform the indicated cut-out and fill the cut-out edges all around with adhesive EA934NA (C057).
 - 3.15.4 With reference to Figure 5 Detail N, drill n°6 holes $\varnothing 3.68 \div 3.81$ thru the FWD panel assy P/N 3G5315A51631 in accordance with the dimensioning shown.
 - 3.15.5 With reference to Figure 5 Section Q-Q, install n°6 inserts P/N NAS1836-08-13 on the FWD panel assy P/N 3G5315A51631 by means of adhesive EA934NA (C057).
 - 3.15.6 With reference to Figure 1 View B, re-install the FWD panel assy reworked.
4. In accordance with AMP DM 39-A-06-41-00-00A-010A-A and with reference to Figures 6 thru 10 and Figures 26 thru 28 Wiring Diagram, gain access to the area affected by the installation and perform kit ICS AV900 cab station 4 P/N 4G2350F00914 as described in the following procedure:
 - 4.1 With reference to Figures 6 thru 9 and Figures 26 thru 28 Wiring Diagram, perform

ICS AV900 cabin station 4 complete prov P/N 4G2350A03313 and install ICS AV900 cabin station 4 elec prov P/N 4G2350A03412 as described in the following procedure:

- 4.1.1 With reference to Figure 9 Detail A, install the stud P/N A366A3E12C75 and the stud P/N A366A3E32C on the structure in the indicated positions.
- 4.1.2 With reference to Figure 8, install n°5 supports P/N AW001CL000A-X3 in the indicated position.
- 4.1.3 With reference to Figure 9 Detail A, install the mounting rail P/N A522A02A by means of n°2 screws P/N NAS1802-08-7 and n°2 washers P/N NAS1149DN816J.
- 4.1.4 Remove and discard the wire R1846B24-S (WH) and (BL) (part of C/A B2B317) from the production P/N 4G2350A03412A12R.

NOTE

Use the edging P/N A236A on edges which are liable to cause damage to cable assemblies or where abrasion may occur.

NOTE

Install the tubing braided P/N A582A where protection against chafing and prevention of contact with structure may occur, but the tubing protection is not substitute for good routing practice.

NOTE

With reference to Figure 27 Wiring Diagram, do not install the C/A B2B317.

- 4.1.5 With reference to Figures 6 thru 9, lay down the following cable assemblies on the existing routes unless otherwise indicated on the figures:
 - 3G9A02B29801 ICS cabin station 4 C/A (A2B298);
 - 3G9B01A43301 ICS cabin station 4 C/A (B1A433);
 - 3G9B02A29901 ICS cabin station 4 C/A (B2A299);
 - 3G9B02A30101 ICS cabin station 4 C/A (B2A301);
 - 3G9B02B31901 ICS cabin station 4 C/A (B2B319).
- 4.1.6 With reference to Figures 6 thru 9, secure the cable assemblies laid down at previous step by means of existing hardware and lacing cord.

- 4.1.7 With reference to Figure 9 Detail A, install the clamp P/N AW001CB13H on C/A B2A299 and C/A B2A301 by means of the spacer P/N NAS43DD3-16N, the screw P/N NAS1802-3-14, the washer P/N NAS1149D0332J and existing hardware.
- 4.1.8 With reference to Figure 9 Detail A, install the clamp P/N AW001CB03H on C/A B1A433 and the clamp P/N AW001CB13H on C/A B2A301 and C/A B2A299 by means of the bracket P/N MS9592-014, the spacer P/N NAS43DD3-20N, the screw P/N NAS1802-3-9, n°3 washers P/N NAS1149D0332J and n°2 nuts P/N MS21042L3.
- 4.1.9 With reference to Figure 9 Detail A, install the clamp P/N AW001CB03H on C/A B1A433 and the clamp P/N AW001CB13H on C/A B2A301 and C/A B2A299 by means of the spacer P/N NAS43DD3-65N, the washer P/N NAS1149D0332J and the nut P/N MS21042L3.
- 4.1.10 With reference to Figure 8, remove and discard the existing screw.
- 4.1.11 With reference to Figure 8, install the clamp P/N AW001CB03H on C/A B1A433 and the clamp P/N AW001CB08H on C/A B2A299 and C/A B2A301 by means of the spacer P/N NAS43DD3-110N, the screw P/N NAS1802-3-28 and existing hardware.
- 4.1.12 With reference to Figure 8, remove and discard n°5 existing screws.
- 4.1.13 With reference to Figure 8, install n°5 clamps P/N AW001CB03H on C/A B1A433 and n°5 clamps P/N AW001CB08H on C/A B2A299 and C/A B2A301 by means of n°5 spacers P/N NAS43DD3-75N, n°5 screws P/N NAS1802-3-26 and existing hardware.
- 4.1.14 With reference to Figure 9 Detail A, install the terminal board P/N A593A-A02 (TB277-2), the terminal board P/N A593A-B03 (TB277-1), the identification plate P/N A524A1A-A and the identification plate P/N A524A2A-A on the mounting rail previously installed.
- 4.1.15 In accordance with AMP DM 39-A-11-00-01-00A-720A-A and with reference to Figure 9 Detail A, apply the decal P/N ED300TB277 next to the terminal board TB277.

NOTE

During the application of the following step, instead of the pin 118 of the TB122P1 it is possible to use pin 116 of the TB122P1.

- 4.1.16 With reference to Figure 7 and Figure 27 Wiring Diagram, perform electrical connection of C/A A2B298 to connector P113 and to terminal board TB122P1. Use n°1 electrical contact P/N M39029/56-348 for TB122P1 and n°1 electrical contact P/N M39029/58-360 for P113.

NOTE

During the application of the following step, do not install wire marked as R1843B20-G between J127 pin L and TB277-1 pin K.

- 4.1.17 With reference to Figures 7 thru 9 and Figure 26 Wiring Diagram, perform electrical connection of C/A B1A433 to connector PL1P3, to terminal board TB209P1, to terminal board TB277-1, to terminal board TB277-2 and to connector J127. Use n°5 electrical contacts P/N A523A-A01 for TB277-2, n°1 electrical contacts P/N A523A-A03 and n°4 electrical contacts P/N A523A-A05 for TB277-1, n°1 electrical contacts P/N M39029/56-351 for J127, n°1 electrical contact P/N M39029/58-363 for PL1P3 and n° 1 electrical contact P/N M39029/56-351 for TB209P1.

NOTE

During the application of the following step, do not install wire marked as R1847A22-S between J133 pin 14 and A189P2 pin M as per figure 27.

- 4.1.18 With reference to Figures 7 and 8 and Figures 26 and 27 Wiring Diagram, perform electrical connection of C/A B2A299 to terminal board TB207, to connector J133 and to connector P205. Use n°1 electrical contact P/N A523A-A02 for TB207, use n°1 electrical contact P/N M39029/56-348 for J133 and use n°4 electrical contacts P/N M39029/58-363 for P205.
- 4.1.19 With reference to Figure 8 and Figure 28 Wiring Diagram, perform electrical connection of C/A B2A301 to connector P205. Use n°8 electrical contacts P/N M39029/58-363 for P205.

NOTE

During the application of the following step, if necessary, relocate the wire marked L3365B22-S (blue) from pin d of the connector J205 to pin KK of the connector J205 and the relative connection wire on P205 side: form pin d to pin KK.

- 4.1.20 With reference to Figure 8 and Figure 28 Wiring Diagram, perform electrical connection of C/A B2B319 to connector J205. Use n°8 electrical contacts P/N M39029/56-351 for J205.
- 4.1.21 With reference to Figure 9 and Figure 28 Wiring Diagram, remove n°4 resistors from C/A B2B313.
- 4.1.22 With reference to Figure 9 and Figure 28 Wiring Diagram, perform electrical connection of C/A B2B313 to C/A B2B319 by means of splices SP2066, SP2068, SP2070 and SP2072.
- 4.2 With reference to Figure 42 Isoview, install the window LWR liner LH P/N 3G2580P10731 in its position on helicopter by means of existing hardware.
- 4.3 With reference to Figure 10, perform the ICS AV900 cabin station 4 electrical installation P/N 4G2350A03211 as described in the following procedure:
 - 4.3.1 With reference to Figure 17 View B, move as shown the ICS gemelli control panel (PL60) already installed on helicopter.
 - 4.3.2 In accordance with AMP DM 39-A-23-57-01-00A-720A-A and with reference to Figure 10 View A and Figure 17 View A and View B, install the AV900 audio panel P/N 7511900-99002 or P/N 7511900-99202 in accordance with the position shown.
 - 4.3.3 In accordance with AMP DM 39-A-11-00-01-00A-720A-A and with reference to Figure 10 View A, apply the decal P/N ED300A189 on the AV900 audio panel block 3 P/N 7511900-99002.
 - 4.3.4 With reference to Figure 10 View B, remove the lock ring P/N Y30700501 from the aux CB panel.
5. In accordance with AMP DM 39-A-06-41-00-00A-010A-A and with reference to Figure 11, gain access to the area affected by the installation and perform 12VDC 5AMP max utility sckts struc prov P/N 3G5311A41011 as described in the following procedure:
 - 5.1 With reference to Figure 11 Section A-A, drill n°4 insert holes $\varnothing 17.42 \pm 17.55$ thru the lower panel assy avionic bay P/N 3G5315A43431 in accordance with the dimensioning shown.

NOTE

Prepare the surface shown on figure for electrical bonding.

NOTE

If the lower panel assy avionics bay P/N 3G5315A43431 is not present on configuration perform the installation of inserts on the under tank panel P/N 3G5338A06632.

- 5.2 With reference to Figure 11 Section A-A, install n°4 inserts P/N NAS1835-08 on the lower panel assy avionics bay P/N 3G5315A43431 by means of adhesive EA934NA (C057).
- 5.3 With reference to Figure 11 View B, install the 12VDC 5 AMP sockets support assy P/N 3G5318A03131 on the FWD panel assy reworked at step 3.15 by means of n°6 screws P/N MS27039-0805 and n°6 washers P/N NAS1149DN816K.
6. In accordance with AMP DM 39-A-06-41-00-00A-010A-A and with reference to Figures 12 thru 14 and Figure 29 Wiring Diagram, gain access to the area affected by the installation and perform 12VDC 5AMP max utility sockets elect instl P/N 3G2460A04811 as described in the following procedure:
 - 6.1 With reference to Figure 13 View A, install n°4 supports P/N AW001CL001-N6 in the indicated positions.
 - 6.2 With reference to Figure 13 View C, install the support P/N AW001CL005A01-X1 in the indicated position.
 - 6.3 With reference to Figure 14 View B, apply the nonmetallic channel P/N A236A02AB85 in the indicated position.
 - 6.4 With reference to Figure 14 View B, install the stud P/N A366A3E16C and n°2 studs P/N A366A3E22C in the indicated positions.

NOTE

Use the edging P/N A236A on edges which are liable to cause damage to cable assemblies or where abrasion may occur.

NOTE

Install the tubing braided P/N A582A where protection against chafing and prevention of contact with structure may occur, but the tubing protection is not substitute for good routing practice.

- 6.5 With reference to Figures 12 thru 14, lay down the following cable assemblies on the existing routes unless otherwise indicated on the figures:
 - 3G9B01L12101 12VDC 5AMP max utility sckts C/A (B1L121);
 - 3G9B01R01901 12VDC 5AMP max utility sckts C/A (B1R19).
- 6.6 With reference to Figures 12 thru 14, secure the cable assemblies laid down at previous step by means of existing hardware and lacing cords.
- 6.7 With reference to Figure 14 View B, install the clamp P/N AW001CB03H on the C/A B1R19 by means of the spacer P/N NAS43DD3-35N, the nut P/N MS21042L3 and the washer P/N NAS1149D0332J.
- 6.8 With reference to Figure 14 View B, install the clamp P/N AW001CB03H on the C/A B1L121 by means of the spacer P/N NAS43DD3-55N, the nut P/N MS21042L3 and the washer P/N NAS1149D0332J.
- 6.9 With reference to Figure 14 View B, install the clamp P/N AW001CB04H on the C/A B1L121 and C/A B1R19 by means of the spacer P/N NAS43DD3-55N, the nut P/N MS21042L3 and the washer P/N NAS1149D0332J.
- 6.10 With reference to Figure 14 View B, install n°2 28VDC/20A utility socket assemblies P/N 3G2460A03231.
- 6.11 With reference to Figure 14 View B, install the power converter (28/14VDC-8A) P/N LT-71 by means of n°4 screws P/N NAS1802-3-7 and n°4 washers P/N NAS1149D0332J.
- 6.12 In accordance with AMP DM 39-A-11-00-01-00A-720A-A and with reference to Figure 14 View B, apply the decal P/N ED300PS108 on the power converter P/N LT-71.
- 6.13 With reference to Figure 14 View B, install the plate P/N A608A01 on the structure.
- 6.14 With reference to Figure 14 View B and Figure 29 Wiring Diagram, perform the electrical connection of C/A B1L121 to GS2105 by means of terminal lug P/N MS25036-103.
- 6.15 With reference to Figure 14 View B, fix the C/A B1L121 to the plate P/N A608A01 by means of the terminal stud assy P/N A363A01.
- 6.16 In accordance with AMP DM 39-A-11-00-01-00A-720A-A and with reference to Figure 14 View B, apply the decal P/N ED300GS2105.
- 6.17 In accordance with AMP DM 39-A-11-00-01-00A-720A-A and with reference to Figure 13 View C, apply n°2 decals P/N ED30012VDC and n°2 decals P/N ED3005A;MAX on the structure.
- 6.18 With reference to Figure 13 View A and Figure 29 Wiring Diagram, perform the electrical connection of C/A B1R19 to connector PL1P2 by means of electrical

- contact P/N M39029/58-364.
- 6.19 With reference to Figure 14 View B and Figure 29 Wiring Diagram, connect the connector PS108P1 to the power converter P/N LT-71.
 - 6.20 With reference to Figure 14 View B and Figure 29 Wiring Diagram, connect the connector P2445 and connector P2447 to n°2 28VDC/20A utility socket assemblies P/N 3G2460A03231 previously installed.
7. In accordance with AMP DM 39-A-06-41-00-00A-010A-A and with reference to Figures 15 thru 20 and Figures 30 thru 39 Wiring Diagram, gain access to the area affected by the installation and perform audio customization upgrade Dubai AW P/N 3G2350P04911 as described in the following procedure:
- 7.1 With reference to Figure 17 View Looking cabin LH side from STA 3120 to STA 3900, install the support AW001CL000A-X3, the stud P/N A366A3E22C, the stud P/N A366A3E16C and the support P/N AW001CL001-N6 in the indicated positions.
 - 7.2 With reference to Figure 18 View Looking down roof RH side from STA 3120 to STA 5700, install the terminal stud assy P/N A363A01 (GS2103) in the indicated position.
 - 7.3 In accordance with AMP DM 39-A-11-00-01-00A-720A-A and with reference to Figure 18 View Looking down roof RH side from STA 3120 to STA 5700, apply the decal P/N ED300GS2103 next to the GS2103.
 - 7.4 With reference to Figure 18 Detail C, install the mounting rail P/N A522A02A by means of n°2 screws P/N NAS1802-06-7 and n°2 washers P/N NAS1149DN616J.
 - 7.5 With reference to Figure 18 Detail C, install the terminal board P/N A593A-A06 (TB2297) and the identification plate P/N A524A1A-A on the mounting rail P/N A522A02A.
 - 7.6 In accordance with AMP DM 39-A-11-00-01-00A-720A-A and with reference to Figure 18 Detail C, apply the decal P/N ED300TB2297 next to the TB2297.
 - 7.7 With reference to Figure 19 View Looking up cabin roof upper panel, install n°3 supports P/NAW001CL001-N6 in the indicated positions.
 - 7.8 With reference to Figure 20 View Looking down secondary avionic bay, install n°2 studs P/N A366A3E32C in the indicated positions.
 - 7.9 With reference to Figure 19, remove the decal P/N ED300ICS;HOIST, the decal P/N ED3002ND;SCKT and the decal P/N ED300J2137.
 - 7.10 With reference to Figure 19, remove and retain the decal P/N ED300CREW1.
 - 7.11 With reference to Figure 20 Detail E, install the relay P/N M83536/26-002L (K429)

- on the bracket and apply the decal P/N ED300K429 on an adjacent area.
- 7.12 With reference to Figure 20 View looking down secondary avionics bay, install the HI Z4 place intercom with transmit P/N AA38-603 (A670) on the support by means of n°4 screws P/N NAS1802-3-9 and n°4 washers P/N NAS1149D0332J. Apply the decal P/N ED300A670 on the A670.
- 7.13 With reference to Figures 36 and 39 Wiring Diagram, remove wires of C/A B1A807, C/A B1A809, C/A B2A677, C/A B1B941 and C/A B2B535.
- 7.14 With reference to Figure 16 and Figure 37 Wiring Diagram, if necessary assemble the audio customization upgrade C/A P/N 3G9A01A68201 (A1A682) as described in the following procedure:
- 7.14.1 With reference to Figure 16 and Figure 37 Wiring Diagram, cut n°1 wire P/N A556A-T20 of adequate length and lay down between terminal board TB129-3 and connector P127.
- 7.14.2 In accordance with AMP DM 39-A-20-10-08-00A-622A-A and with reference to Figure 37 Wiring Diagram, crimp on wire n°1 electrical contact P/N A523A-A02 (TB129-3 side) and n°1 electrical contact P/N M39029/58-363 (P127 side) by means of proper crimping tool.
- 7.14.3 In accordance with AMP DM 39-A-20-10-18-00A-691A-A and with reference to Figure 37 Wiring Diagram, mark wire as R12155A20-G by means of marker sleeves.
- 7.14.4 With reference to Figure 16 and Figure 37 Wiring Diagram, cut n°1 wire P/N A556A-T20 of adequate length and lay down between terminal board TB153 and connector P127.
- 7.14.5 In accordance with AMP DM 39-A-20-10-08-00A-622A-A and with reference to Figure 37 Wiring Diagram, crimp on wire n°1 electrical contact P/N A523A-A02 (TB153 side) and n°1 electrical contact P/N M39029/58-363 (P127 side) by means of proper crimping tool.
- 7.14.6 In accordance with AMP DM 39-A-20-10-18-00A-691A-A and with reference to Figure 37 Wiring Diagram, mark wire as R12156B20N-G by means of marker sleeves.
- 7.14.7 In accordance with AMP DM 39-A-20-10-18-00A-691A-A and Figure 37 Wiring Diagram, mark the cable assembly so obtained as A1A682 by means of marker sleeves.
- 7.15 With reference to Figure 16 and Figure 38 Wiring Diagram, if necessary assemble the audio customization upgrade C/A P/N 3G9A02A61901 (A2A619) as described in the following procedure:

- 7.15.1 With reference to Figure 16 and Figure 38 Wiring Diagram, cut n°1 wire P/N A556A-T22 of adequate length and lay down between connector J113 and connector P133.
- 7.15.2 In accordance with AMP DM 39-A-20-10-08-00A-622A-A and with reference to Figure 38 Wiring Diagram, crimp on wire n°1 electrical contact P/N M39029/56-348 (J113 side) and n°1 electrical contact P/N M39029/58-360 (P133 side) by means of proper crimping tool.
- 7.15.3 In accordance with AMP DM 39-A-20-10-18-00A-691A-A and with reference to Figure 38 Wiring Diagram, mark wire as R12158B22-S by means of marker sleeves.
- 7.15.4 In accordance with AMP DM 39-A-20-10-18-00A-691A-A and Figure 38 Wiring Diagram, mark the cable assembly so obtained as A2A619 by means of marker sleeves.
- 7.16 With reference to Figures 16 thru 20 and Figures 30 thru 33 and 37 Wiring Diagram, if necessary assemble the audio customization upgrade C/A P/N 3G9B01L12001 (B1L120) as described in the following procedure:
 - 7.16.1 With reference to Figure 19, install the connector P/N 18-240 (S408P1) and the connector switch P/N LED-6A-45-KA-38735. Apply the decal P/N ED300S408 and the decal P/N ED300RADIO;ICS in an adjacent area.
 - 7.16.2 With reference to Figure 19, install the connector P/N 18-240 (S409P1) and the connector switch P/N LED-6A-45-KA-38735. Apply the decal P/N ED300S409 and the decal P/N ED300RADIO;ICS in an adjacent area.
 - 7.16.3 With reference to Figure 20 Detail E, install the socket relay P/N M12883/47-10S (K429P1) on the relay K429 previously installed.
 - 7.16.4 With reference to figure 20 install the connector A670P102 by means of the electrical connector P/N D37000GVL0 and the backshell P/N SD37F10GVL0 on the HI Z4 place intercom with transmit P/N AA38-603.
 - 7.16.5 With reference to figure 20 install the connector A670P102 by means of the electrical connector P/N D37000GVL0 and the backshell P/N SD37F10GVL0 on the HI Z4 place intercom with transmit P/N AA38-603.

- 7.16.6 With reference to Figures 16 and 17 and Figure 37 Wiring Diagram, cut n°1 wire P/N A556A-T20 of adequate length and lay down between connector J127 and terminal board TB277-1.
- 7.16.7 In accordance with AMP DM 39-A-20-10-08-00A-622A-A and with reference to Figure 37 Wiring Diagram, crimp on wire n°1 electrical contact P/N M39029/56-351 (J127 side) and n°1 electrical contact P/N A523A-A02 (TB277-1 side) by means of proper crimping tool.
- 7.16.8 In accordance with AMP DM 39-A-20-10-18-00A-691A-A and with reference to Figure 37 Wiring Diagram, mark wire as R12156A20-G by means of marker sleeves.
- 7.16.9 With reference to Figure 30 Wiring Diagram, remove n°1 wire marked as "R1840A22-G" between PL1P3 and TB277-2 of C/A B1A433.
- 7.16.10 With reference to Figures 17 and 18 and Figure 30 Wiring Diagram, cut n°1 wire P/N A556A-T22 of adequate length and lay down between terminal board TB277-2 and splice SP21524.
- 7.16.11 In accordance with AMP DM 39-A-20-10-08-00A-622A-A and with reference to Figure 30 Wiring Diagram, crimp on wire n°1 electrical contact P/N A523A-A01 (TB277-2 side) by means of proper crimping tool.
- 7.16.12 In accordance with AMP DM 39-A-20-10-18-00A-691A-A and with reference to Figure 30 Wiring Diagram, mark wire as R12110C22-G by means of marker sleeves.
- 7.16.13 With reference to Figures 16 and 18 and Figure 30 Wiring Diagram, cut n°1 wire P/N A556A-T20 of adequate length and lay down between connector PL1P3 and splice SP21524.
- 7.16.14 In accordance with AMP DM 39-A-20-10-08-00A-622A-A and with reference to Figure 30 Wiring Diagram, crimp on wire n°1 electrical contact P/N M39029/58-363 (PL1P3 side) by means of proper crimping tool.
- 7.16.15 In accordance with AMP DM 39-A-20-10-18-00A-691A-A and with reference to Figure 30 Wiring Diagram, mark wire as R12110A20-G by means of marker sleeves.
- 7.16.16 With reference to Figures 17 and 20 and Figure 30 Wiring Diagram, cut n°1 wire P/N A556A-T20 of adequate length and lay down between splice SP21526 and splice SP21524.

- 7.16.17 In accordance with AMP DM 39-A-20-10-18-00A-691A-A and with reference to Figure 30 Wiring Diagram, mark wire as R12110D20-G by means of marker sleeves.
- 7.16.18 With reference to Figures 18 and 20 and Figure 30 Wiring Diagram, cut n°1 wire P/N A556A-T20 of adequate length and lay down between connector A670P101 and splice SP21524.
- 7.16.19 In accordance with AMP DM 39-A-20-10-08-00A-622A-A and with reference to Figure 30 Wiring Diagram, crimp on wire n°1 electrical contact P/N FC7520D (A670P101 side) by means of proper crimping tool.
- 7.16.20 In accordance with AMP DM 39-A-20-10-18-00A-691A-A and with reference to Figure 30 Wiring Diagram, mark wire as R12110B20-G by means of marker sleeves.
- 7.16.21 With reference to Figure 30 Wiring Diagram, perform electrical connection between wires marked as R12110C22-G, R12110A20-G, R12110D20-G and R12110B20-G by means of splice P/N M81824/1-2 (SP21524).
- 7.16.22 With reference to Figure 20 and Figure 30 Wiring Diagram, cut n°1 wire P/N A556A-T20 of adequate length and lay down between connector A670P102 and splice SP21526.
- 7.16.23 In accordance with AMP DM 39-A-20-10-08-00A-622A-A and with reference to Figure 30 Wiring Diagram, crimp on wire n°1 electrical contact P/N FC7520D (A670P102 side) by means of proper crimping tool.
- 7.16.24 In accordance with AMP DM 39-A-20-10-18-00A-691A-A and with reference to Figure 30 Wiring Diagram, mark wire as R12110E20-G by means of marker sleeves.
- 7.16.25 With reference to Figure 20 and Figure 31 Wiring Diagram, cut n°1 wire P/N A556A-T20 of adequate length and lay down between relay K429P1 and splice SP21526.
- 7.16.26 In accordance with AMP DM 39-A-20-10-08-00A-622A-A and with reference to Figure 31 Wiring Diagram, crimp on wire n°1 electrical contact P/N M39029/5-116 (K429P1 side) by means of proper crimping tool.

- 7.16.27 In accordance with AMP DM 39-A-20-10-18-00A-691A-A and with reference to Figure 31 Wiring Diagram, mark wire as R12110F20-G by means of marker sleeves.
- 7.16.28 With reference to Figures 30 and 31 Wiring Diagram, perform electrical connection between wires marked as R12110F20-G, R12110E20-G and R12110D20-G by means of splice P/N M81824/1-2 (SP21526).
- 7.16.29 With reference to Figure 20 and Figure 30 Wiring Diagram, cut n°1 wire P/N A556A-T20 of adequate length and lay down between connector A670P102 and splice SP21525.
- 7.16.30 In accordance with AMP DM 39-A-20-10-08-00A-622A-A and with reference to Figure 30 Wiring Diagram, crimp on wire n°1 electrical contact P/N FC7520D (A670P102 side) by means of proper crimping tool.
- 7.16.31 In accordance with AMP DM 39-A-20-10-18-00A-691A-A and with reference to Figure 30 Wiring Diagram, mark wire as R12111B20-G by means of marker sleeves.
- 7.16.32 With reference to Figures 18 and 20 and Figure 30 Wiring Diagram, cut n°1 wire P/N A556A-T20 of adequate length and lay down between ground stud GS2103 and splice SP21525.
- 7.16.33 In accordance with AMP DM 39-A-20-10-08-00A-622A-A and with reference to Figure 30 Wiring Diagram, crimp on wire n°1 electrical contact P/N MS25036-103 (GS2103 side) by means of proper crimping tool.
- 7.16.34 In accordance with AMP DM 39-A-20-10-18-00A-691A-A and with reference to Figure 30 Wiring Diagram, mark wire as R12111C20N-G by means of marker sleeves.
- 7.16.35 With reference to Figure 20 and Figure 30 Wiring Diagram, cut n°1 wire P/N A556A-T20 of adequate length and lay down between connector A670P101 and splice SP21525.
- 7.16.36 In accordance with AMP DM 39-A-20-10-08-00A-622A-A and with reference to Figure 30 Wiring Diagram, crimp on wire n°1 electrical contact P/N FC7520D (A670P101 side) by means of proper crimping tool.
- 7.16.37 In accordance with AMP DM 39-A-20-10-18-00A-691A-A and with reference to Figure 30 Wiring Diagram, mark wire as R12111A20-G by means of marker sleeves.

- 7.16.38 With reference to Figure 30 Wiring Diagram, perform electrical connection between wires marked as R12111A20-G, R12111C20N-G and R12111B20-G by means of splice P/N M81824/1-2 (SP21525).
- 7.16.39 With reference to Figure 20 and Figure 31 Wiring Diagram, cut n°1 wire P/N A556A-T20 of adequate length and lay down between relay K429P1 and connector A670P102.
- 7.16.40 In accordance with AMP DM 39-A-20-10-08-00A-622A-A and with reference to Figure 31 Wiring Diagram, crimp on wire n°1 electrical contact P/N M39029/5-116 (K429P1 side) and n°1 electrical contact P/N FC7520D (A670P102 side) by means of proper crimping tool.
- 7.16.41 In accordance with AMP DM 39-A-20-10-18-00A-691A-A and with reference to Figure 31 Wiring Diagram, mark wire as R12112A20-G by means of marker sleeves.
- 7.16.42 With reference to Figures 17 and 19 and Figure 32 Wiring Diagram, cut n°1 wire P/N A556A-T24 of adequate length and lay down between terminal board TB277-2 and splice SP21534.
- 7.16.43 In accordance with AMP DM 39-A-20-10-08-00A-622A-A and with reference to Figure 32 Wiring Diagram, crimp on wire n°1 electrical contact P/N A523A-A01 (TB277-2 side) by means of proper crimping tool.
- 7.16.44 In accordance with AMP DM 39-A-20-10-18-00A-691A-A and with reference to Figure 32 Wiring Diagram, mark wire as R12129A24-G by means of marker sleeves.
- 7.16.45 With reference to Figure 19 and Figure 32 Wiring Diagram, cut n°2 wires P/N A556A-T24 of adequate length and lay down between connector S408P1 and splice SP21534.
- 7.16.46 In accordance with AMP DM 39-A-20-10-08-00A-622A-A and with reference to Figure 32 Wiring Diagram, crimp on wires n°2 electrical contacts P/N M39029/22-192 (S408P1 side) by means of proper crimping tool.
- 7.16.47 In accordance with AMP DM 39-A-20-10-18-00A-691A-A and with reference to Figure 32 Wiring Diagram, mark wires as R12129B24-G and R12129C24-G by means of marker sleeves.
- 7.16.48 With reference to Figure 32 Wiring Diagram, perform electrical connection between wires marked as R12129B24-G, R12129C24-G and R12129A24-G by means of splice P/N M81824/1-1 (SP21534).

- 7.16.49 With reference to Figure 19 and Figure 32 Wiring Diagram, cut n°3 wires P/N A556A-T24 of adequate length and lay down between connector S408P1 and splice SP21533.
- 7.16.50 In accordance with AMP DM 39-A-20-10-08-00A-622A-A and with reference to Figure 32 Wiring Diagram, crimp on wires n°3 electrical contacts P/N M39029/22-192 (S408P1 side) by means of proper crimping tool.
- 7.16.51 In accordance with AMP DM 39-A-20-10-18-00A-691A-A and with reference to Figure 32 Wiring Diagram, mark wires as R12130B24-G, R12130C24-G and R12130A24-G by means of marker sleeves.
- 7.16.52 With reference to Figure 32 Wiring Diagram, perform electrical connection between wires marked as R12130B24-G, R12130C24-G and R12130A24-G by means of splice P/N M81824/1-1 (SP21533).
- 7.16.53 With reference to Figure 19 and Figure 32 Wiring Diagram, cut n°3 wires P/N A556A-T24 of adequate length and lay down between connector S408P1 and splice SP21532.
- 7.16.54 In accordance with AMP DM 39-A-20-10-08-00A-622A-A and with reference to Figure 32 Wiring Diagram, crimp on wires n°3 electrical contacts P/N M39029/22-192 (S408P1 side) by means of proper crimping tool.
- 7.16.55 In accordance with AMP DM 39-A-20-10-18-00A-691A-A and with reference to Figure 32 Wiring Diagram, mark wires as R12131A24-G, R12131B24-G and R12131C24-G by means of marker sleeves.
- 7.16.56 With reference to Figure 32 Wiring Diagram, perform electrical connection between wires marked as R12131A24-G, R12131B24-G and R12131C24-G by means of splice P/N M81824/1-1 (SP21532).
- 7.16.57 With reference to Figure 19 and Figure 32 Wiring Diagram, cut n°1 wire P/N A556A-T24 of adequate length and lay down between connector S408P1 and splice SP21535.
- 7.16.58 In accordance with AMP DM 39-A-20-10-08-00A-622A-A and with reference to Figure 32 Wiring Diagram, crimp on wire n°1 electrical contact P/N M39029/22-192 (S408P1 side) by means of proper crimping tool.
- 7.16.59 In accordance with AMP DM 39-A-20-10-18-00A-691A-A and with reference to Figure 32 Wiring Diagram, mark wires as R12132A24-G by means of marker sleeves.

- 7.16.60 With reference to Figures 18 and 19 and Figure 32 Wiring Diagram, cut n°1 wire P/N A556A-T24 of adequate length and lay down between terminal board TB211 and splice SP21535.
- 7.16.61 In accordance with AMP DM 39-A-20-10-08-00A-622A-A and with reference to Figure 32 Wiring Diagram, crimp on wire n°1 electrical contact P/N A523A-A05 (TB211 side) by means of proper crimping tool.
- 7.16.62 In accordance with AMP DM 39-A-20-10-18-00A-691A-A and with reference to Figure 32 Wiring Diagram, mark wires as R12132B24N-G by means of marker sleeves.
- 7.16.63 With reference to Figure 19 and Figure 33 Wiring Diagram, cut n°1 wire P/N A556A-T24 of adequate length and lay down between connector S409P1 and splice SP21535.
- 7.16.64 In accordance with AMP DM 39-A-20-10-08-00A-622A-A and with reference to Figure 33 Wiring Diagram, crimp on wire n°1 electrical contact P/N M39029/22-192 (S409P1 side) by means of proper crimping tool.
- 7.16.65 In accordance with AMP DM 39-A-20-10-18-00A-691A-A and with reference to Figure 33 Wiring Diagram, mark wires as R12132C24-G by means of marker sleeves.
- 7.16.66 With reference to Figures 32 and 33 Wiring Diagram, perform electrical connection between wires marked as R12132C24-G, R12132B24N-G and R12132A24-G by means of splice P/N M81824/1-1 (SP21535).
- 7.16.67 With reference to Figures 17 and 19 and Figure 33 Wiring Diagram, cut n°1 wire P/N A556A-T24 of adequate length and lay down between terminal board TB277-2 and splice SP21539.
- 7.16.68 In accordance with AMP DM 39-A-20-10-08-00A-622A-A and with reference to Figure 33 Wiring Diagram, crimp on wire n°1 electrical contact P/N A523A-A01 (TB277-2 side) by means of proper crimping tool.
- 7.16.69 In accordance with AMP DM 39-A-20-10-18-00A-691A-A and with reference to Figure 33 Wiring Diagram, mark wire as R12139A24-G by means of marker sleeves.
- 7.16.70 With reference to Figure 19 and Figure 33 Wiring Diagram, cut n°2 wires P/N A556A-T24 of adequate length and lay down between connector S409P1 and splice SP21539.

- 7.16.71 In accordance with AMP DM 39-A-20-10-08-00A-622A-A and with reference to Figure 33 Wiring Diagram, crimp on wires n°2 electrical contacts P/N M39029/22-192 (S409P1 side) by means of proper crimping tool.
- 7.16.72 In accordance with AMP DM 39-A-20-10-18-00A-691A-A and with reference to Figure 33 Wiring Diagram, mark wires as R12139B24-G and R12139C24-G by means of marker sleeves.
- 7.16.73 With reference to Figure 33 Wiring Diagram, perform electrical connection between wires marked as R12139B24-G, R12139C24-G and R12139A24-G by means of splice P/N M81824/1-1 (SP21539).
- 7.16.74 With reference to Figure 19 and Figure 33 Wiring Diagram, cut n°3 wires P/N A556A-T24 of adequate length and lay down between connector S409P1 and splice SP21538.
- 7.16.75 In accordance with AMP DM 39-A-20-10-08-00A-622A-A and with reference to Figure 33 Wiring Diagram, crimp on wires n°3 electrical contacts P/N M39029/22-192 (S409P1 side) by means of proper crimping tool.
- 7.16.76 In accordance with AMP DM 39-A-20-10-18-00A-691A-A and with reference to Figure 33 Wiring Diagram, mark wires as R12140B24-G, R12140C24-G and R12140A24-G by means of marker sleeves.
- 7.16.77 With reference to Figure 33 Wiring Diagram, perform electrical connection between wires marked as R12140B24-G, R12140C24-G and R12140A24-G by means of splice P/N M81824/1-1 (SP21538).
- 7.16.78 With reference to Figure 19 and Figure 33 Wiring Diagram, cut n°3 wires P/N A556A-T24 of adequate length and lay down between connector S409P1 and splice SP21537.
- 7.16.79 In accordance with AMP DM 39-A-20-10-08-00A-622A-A and with reference to Figure 33 Wiring Diagram, crimp on wires n°3 electrical contacts P/N M39029/22-192 (S409P1 side) by means of proper crimping tool.
- 7.16.80 In accordance with AMP DM 39-A-20-10-18-00A-691A-A and with reference to Figure 33 Wiring Diagram, mark wires as R12141A24-G, R12141B24-G and R12141C24-G by means of marker sleeves.
- 7.16.81 With reference to Figure 33 Wiring Diagram, perform electrical connection between wires marked as R12141A24-G, R12141B24-G and R12141C24-G by means of splice P/N M81824/1-1 (SP21537).

- 7.16.82 In accordance with AMP DM 39-A-20-10-18-00A-691A-A and Figures 30 thru 33 and 37 Wiring Diagram, mark the cable assembly so obtained as B1L120 by means of marker sleeves.
- 7.17 With reference to Figure 39 Wiring Diagram remove wire R10350A24-S (white) from pin 37 of TB202P1 to pin 39 and wire R10350A24-S (blue) from pin 49 of TB202P1 to pin 51.
- 7.18 With reference to Figure 18 and Figure 38 Wiring Diagram, perform electrical connection of C/A P/N 3G9B02B74601 (B2B746) to connector J205 and to connector TB202P1. Use n°2 electrical contacts P/N M39029/56-351 for J205 and n°2 electrical contacts P/N M39029/56-348 for TB202P1.
- 7.19 With reference to Figure 19 remove the cover P/N MS3181-12CA, the flange P/N M85049/95-12A-A, existing hardware and the decal P/N ED300J2135.
- 7.20 With reference to Figures 16 thru 20 and Figures 31 thru 38 Wiring Diagram, if necessary assemble the audio customization upgrade C/A P/N 3G9B02L11501 (B2L115) as described in the following procedure:
- 7.20.1 With reference to Figure 19, install the connector P/N MS3470L12-10S (HT128J1) by means of the flange P/N M85049/95-12A-A, n°4 washers P/N NAS1149DN416J, n°4 screws P/N NAS1802-04-6 and the cover P/N MS3181-12CA. Apply the decal P/N ED300HT128J1 and the decal P/N ED300CREW1 in an adjacent area.
- 7.20.2 With reference to Figure 19, install the connector P/N MS3470L12-10S (HT129J1) and the adapter P/N A532A300-1203C by means of the flange P/N M85049/95-12A-A, n°4 washers P/N NAS1149DN416J, n°4 screws P/N NAS1802-04-6 and the cover P/N MS3181-12CA. Apply the decal P/N ED300HT129J1 in an adjacent area.
- 7.20.3 With reference to Figure 19, install the connector P/N 350781-1 (J2441). Apply the decal P/N ED300J2441 in an adjacent area.
- 7.20.4 With reference to Figures 17 and 20 and Figure 31 Wiring Diagram, cut n°1 wire P/N A561A-T2-24 of adequate length and lay down between connector A670P101 and connector A189P1.
- 7.20.5 In accordance with AMP DM 39-A-20-10-08-00A-622A-A and with reference to Figure 31 Wiring Diagram, crimp on wire n°1 electrical contact P/N FC7520D (A670P101 side) and n°1 electrical contact P/N M39029/57-357 (A189P1 side) by means of proper crimping tool.

- 7.20.6 In accordance with AMP DM 39-A-20-10-18-00A-691A-A and with reference to Figure 31 Wiring Diagram, mark wire as R12118G24-S(WH) by means of marker sleeves.
- 7.20.7 With reference to Figures 18 and 20 and Figure 31 Wiring Diagram, cut n°1 wire P/N A561A-T2-24 of adequate length and lay down between connector A670P101 and splice SP21530.
- 7.20.8 In accordance with AMP DM 39-A-20-10-08-00A-622A-A and with reference to Figure 31 Wiring Diagram, crimp on wire n°1 electrical contact P/N FC7520D (A670P101 side) by means of proper crimping tool.
- 7.20.9 In accordance with AMP DM 39-A-20-10-18-00A-691A-A and with reference to Figure 31 Wiring Diagram, mark wire as R12118G24-S(BL) by means of marker sleeves.
- 7.20.10 With reference to Figures 17 and 18 and Figure 31 Wiring Diagram, cut n°1 wire P/N A556A-T24 of adequate length and lay down between splice SP21529 and splice SP21530.
- 7.20.11 In accordance with AMP DM 39-A-20-10-18-00A-691A-A and with reference to Figure 31 Wiring Diagram, mark wire as R12118E24-S by means of marker sleeves.
- 7.20.12 With reference to Figure 18 and Figure 31 Wiring Diagram, cut n°1 wire P/N A556-T24 of adequate length and lay down between terminal board TB207 and splice SP21530.
- 7.20.13 In accordance with AMP DM 39-A-20-10-08-00A-622A-A and with reference to Figure 31 Wiring Diagram, crimp on wire n°1 electrical contact P/N A523A-A05 (TB207 side) by means of proper crimping tool.
- 7.20.14 In accordance with AMP DM 39-A-20-10-18-00A-691A-A and with reference to Figure 31 Wiring Diagram, mark wire as R12118H24N-S by means of marker sleeves.
- 7.20.15 With reference to Figures 18 and 20 and Figure 31 Wiring Diagram, cut n°1 wire P/N A556-T24 of adequate length and lay down between relay K429P1 and splice SP21530.
- 7.20.16 In accordance with AMP DM 39-A-20-10-08-00A-622A-A and with reference to Figure 31 Wiring Diagram, crimp on wire n°1 electrical contact P/N M39029/5-117 (K429P1 side) by means of proper crimping tool.

- 7.20.17 In accordance with AMP DM 39-A-20-10-18-00A-691A-A and with reference to Figure 31 Wiring Diagram, mark wire as R12118F24-S by means of marker sleeves.
- 7.20.18 With reference to Figure 31 Wiring Diagram, perform electrical connection between wires marked as R12118F24-S, R12118H24N-S, R12118E24-S and R12118G24-S(BL) by means of splice P/N M81824/1-1 (SP21530).
- 7.20.19 With reference to Figure 17 and Figure 31 Wiring Diagram, cut n°2 wires P/N A556A-T24 of adequate length and lay down between connector A189P1 and splice SP21529.
- 7.20.20 In accordance with AMP DM 39-A-20-10-08-00A-622A-A and with reference to Figure 31 Wiring Diagram, crimp on wires n°2 electrical contacts P/N M39029/57-357 (A189P1 side) by means of proper crimping tool.
- 7.20.21 In accordance with AMP DM 39-A-20-10-18-00A-691A-A and with reference to Figure 31 Wiring Diagram, mark wires as R12118C24-S and R12118D24-S by means of marker sleeves.
- 7.20.22 With reference to Figures 17 and 20 and Figure 31 Wiring Diagram, cut n°1 wire P/N A556A-T24 of adequate length and lay down between splice SP21529 and splice SP21528.
- 7.20.23 In accordance with AMP DM 39-A-20-10-18-00A-691A-A and with reference to Figure 31 Wiring Diagram, mark wire as R12118B24-S by means of marker sleeves.
- 7.20.24 With reference to Figure 31 Wiring Diagram, perform electrical connection between wires marked as R12118C24-S, R12118B24-S, R12118D24-S and R12118E24-S by means of splice P/N M81824/1-1 (SP21529).
- 7.20.25 With reference to Figure 20 and Figure 31 Wiring Diagram, cut n°1 wire P/N A561A-T2-24 of adequate length and lay down between relay K429P1 and splice SP21528.
- 7.20.26 In accordance with AMP DM 39-A-20-10-08-00A-622A-A and with reference to Figure 31 Wiring Diagram, crimp on wire n°1 electrical contact P/N M39029/5-117 (K429P1 side) by means of proper crimping tool.

- 7.20.27 In accordance with AMP DM 39-A-20-10-18-00A-691A-A and with reference to Figure 31 Wiring Diagram, mark wire as R12118A24-S(BL) by means of marker sleeves.
- 7.20.28 With reference to Figures 19 and 20 and Figure 31 Wiring Diagram, cut n°1 wire P/N A556A-T24 of adequate length and lay down between splice SP21527 and splice SP21528.
- 7.20.29 In accordance with AMP DM 39-A-20-10-18-00A-691A-A and with reference to Figure 31 Wiring Diagram, mark wire as R12118J24-S by means of marker sleeves.
- 7.20.30 With reference to Figure 31 Wiring Diagram, perform electrical connection between wires marked as R12118J24-S, R12118A24-S(BL) and R12118B24-S by means of splice P/N M81824/1-1 (SP21528).
- 7.20.31 With reference to Figure 19 and Figure 32 Wiring Diagram, cut n°1 wire P/N A556A-T24 of adequate length and lay down between connector HT128J1 and splice SP21527.
- 7.20.32 In accordance with AMP DM 39-A-20-10-08-00A-622A-A and with reference to Figure 32 Wiring Diagram, crimp on wire n°1 electrical contact P/N M39029/5-115 (HT128J1 side) by means of proper crimping tool.
- 7.20.33 In accordance with AMP DM 39-A-20-10-18-00A-691A-A and with reference to Figure 32 Wiring Diagram, mark wire as R12118K24-S by means of marker sleeves.
- 7.20.34 With reference to Figure 19 and Figure 33 Wiring Diagram, cut n°1 wire P/N A556A-T24 of adequate length and lay down between connector HT129J1 and splice SP21527.
- 7.20.35 In accordance with AMP DM 39-A-20-10-08-00A-622A-A and with reference to Figure 33 Wiring Diagram, crimp on wire n°1 electrical contact P/N M39029/5-115 (HT129J1 side) by means of proper crimping tool.
- 7.20.36 In accordance with AMP DM 39-A-20-10-18-00A-691A-A and with reference to Figure 33 Wiring Diagram, mark wire as R12118L24-S by means of marker sleeves.
- 7.20.37 With reference to Figures 31, 32 and 33 Wiring Diagram, perform electrical connection between wires marked as R12118L24-S, R12118K24-S and R12118J24-S by means of splice P/N M81824/1-1 (SP21527).

- 7.20.38 With reference to Figures 17 and 20 and Figure 31 Wiring Diagram, cut n°1 wire P/N A556A-T24 of adequate length and lay down between relay K429P1 and connector A189P2.
- 7.20.39 In accordance with AMP DM 39-A-20-10-08-00A-622A-A and with reference to Figure 31 Wiring Diagram, crimp on wire n°1 electrical contact P/N M39029/5-117 (K429P1 side) and n°1 electrical contact P/N M39029/57-357 (A189P2 side) by means of proper crimping tool.
- 7.20.40 In accordance with AMP DM 39-A-20-10-18-00A-691A-A and with reference to Figure 31 Wiring Diagram, mark wire as R12120A24-S by means of marker sleeves.
- 7.20.41 With reference to Figures 17 and 20 and Figure 31 Wiring Diagram, cut n°1 wire P/N A561A-T2-24 of adequate length and lay down between relay K429P1 and connector A189P1.
- 7.20.42 In accordance with AMP DM 39-A-20-10-08-00A-622A-A and with reference to Figure 31 Wiring Diagram, crimp on wire n°1 electrical contact P/N M39029/5-117 (K429P1 side) and n°1 electrical contact P/N M39029/57-357 (A189P1 side) by means of proper crimping tool.
- 7.20.43 In accordance with AMP DM 39-A-20-10-18-00A-691A-A and with reference to Figure 31 Wiring Diagram, mark wire as R12118A24-S(WH) by means of marker sleeves.
- 7.20.44 With reference to Figures 17 and 20 and Figure 31 Wiring Diagram, cut n°1 wire P/N A556A-T24 of adequate length and lay down between relay K429P1 and connector A189P1.
- 7.20.45 In accordance with AMP DM 39-A-20-10-08-00A-622A-A and with reference to Figure 31 Wiring Diagram, crimp on wire n°1 electrical contact P/N M39029/5-117 (K429P1 side) and n°1 electrical contact P/N M39029/57-357 (A189P1 side) by means of proper crimping tool.
- 7.20.46 In accordance with AMP DM 39-A-20-10-18-00A-691A-A and with reference to Figure 31 Wiring Diagram, mark wire as R12119A24-S by means of marker sleeves.
- 7.20.47 With reference to Figures 18 and 20 and Figure 31 Wiring Diagram, cut n°1 wire P/N A556A-T24 of adequate length and lay down between relay K429P1 and terminal board TB2297-1.
- 7.20.48 In accordance with AMP DM 39-A-20-10-08-00A-622A-A and with reference to Figure 31 Wiring Diagram, crimp on wire n°1 electrical

- contact P/N M39029/5-117 (K429P1 side) and n°1 electrical contact P/N A523A-A01 (TB2297-1 side) by means of proper crimping tool.
- 7.20.49 In accordance with AMP DM 39-A-20-10-18-00A-691A-A and with reference to Figure 31 Wiring Diagram, mark wire as R12117A24-S by means of marker sleeves.
- 7.20.50 With reference to Figure 20 and Figure 31 Wiring Diagram, cut n°2 wires P/N A561A-T2-24 of adequate length and lay down between relay K429P1 and connector A670P102.
- 7.20.51 In accordance with AMP DM 39-A-20-10-08-00A-622A-A and with reference to Figure 31 Wiring Diagram, crimp on wires n°2 electrical contacts P/N M39029/5-117 (K429P1 side) and n°2 electrical contacts P/N FC7520D (A670P102 side) by means of proper crimping tool.
- 7.20.52 In accordance with AMP DM 39-A-20-10-18-00A-691A-A and with reference to Figure 31 Wiring Diagram, mark wires as R12113A24-S(WH) and R12113A24-S(BL) by means of marker sleeves.
- 7.20.53 With reference to Figure 20 and Figure 31 Wiring Diagram, cut n°1 wire P/N A556A-T22 of adequate length and lay down between connector A670P102 and connector A670P102.
- 7.20.54 In accordance with AMP DM 39-A-20-10-08-00A-622A-A and with reference to Figure 31 Wiring Diagram, crimp on wire n°1 on pin "31" electrical contact P/N FC7520D (A670P102 side) by means of proper crimping tool.
- 7.20.55 In accordance with AMP DM 39-A-20-10-18-00A-691A-A and with reference to Figure 31 Wiring Diagram, mark wire as R12114A22-S by means of marker sleeves.
- 7.20.56 With reference to Figure 20 and Figure 31 Wiring Diagram, cut n°2 wires P/N A561A-T2-24 of adequate length and lay down between relay K429P1 and connector A670P101.
- 7.20.57 In accordance with AMP DM 39-A-20-10-08-00A-622A-A and with reference to Figure 31 Wiring Diagram, crimp on wires n°2 electrical contacts P/N M39029/5-117 (K429P1 side) and n°2 electrical contacts P/N FC7520D (A670P101 side) by means of proper crimping tool.
- 7.20.58 In accordance with AMP DM 39-A-20-10-18-00A-691A-A and with reference to Figure 31 Wiring Diagram, mark wires as R12115A24-S(WH) and R12115A24-S(BL) by means of marker sleeves.

- 7.20.59 With reference to Figure 20 and Figure 31 Wiring Diagram, cut n°1 wire P/N A556A-T22 of adequate length and lay down between connector A670P101 and connector A670P101.
- 7.20.60 In accordance with AMP DM 39-A-20-10-08-00A-622A-A and with reference to Figure 31 Wiring Diagram, crimp on wire on pin "19" n°1 electrical contact P/N FC7520D (A670P101 side) by means of proper crimping tool.
- 7.20.61 In accordance with AMP DM 39-A-20-10-18-00A-691A-A and with reference to Figure 31 Wiring Diagram, mark wire as R12116A22-S by means of marker sleeves.
- 7.20.62 With reference to Figures 19 and 20 and Figure 32 Wiring Diagram, cut n°2 wires P/N A561A-T2-24 of adequate length and lay down between connector HT128J1 and connector A670P101.
- 7.20.63 In accordance with AMP DM 39-A-20-10-08-00A-622A-A and with reference to Figure 32 Wiring Diagram, crimp on wires n°2 electrical contacts P/N M39029/5-115 (HT128J1 side) and n°2 electrical contacts P/N FC7520D (A670P101 side) by means of proper crimping tool.
- 7.20.64 In accordance with AMP DM 39-A-20-10-18-00A-691A-A and with reference to Figure 32 Wiring Diagram, mark wires as R12121A24-S(WH) and R12121A24-S(BL) by means of marker sleeves.
- 7.20.65 With reference to Figure 20 and Figure 32 Wiring Diagram, cut n°1 wire P/N A556A-T22 of adequate length and lay down between connector A670P101 and connector A670P101.
- 7.20.66 In accordance with AMP DM 39-A-20-10-08-00A-622A-A and with reference to Figure 32 Wiring Diagram, crimp on wire on pin "30" n°1 electrical contact P/N FC7520D (A670P101 side) by means of proper crimping tool.
- 7.20.67 In accordance with AMP DM 39-A-20-10-18-00A-691A-A and with reference to Figure 32 Wiring Diagram, mark wire as R12122A22-S by means of marker sleeves.
- 7.20.68 With reference to Figures 19 and 20 and Figure 32 Wiring Diagram, cut n°2 wires P/N A561A-T2-24 of adequate length and lay down between connector HT128J1 and connector A670P102.
- 7.20.69 In accordance with AMP DM 39-A-20-10-08-00A-622A-A and with reference to Figure 32 Wiring Diagram, crimp on wires n°2 electrical

- contacts P/N M39029/5-115 (HT128J1 side) and n°2 electrical contacts P/N FC7520D (A670P102 side) by means of proper crimping tool.
- 7.20.70 In accordance with AMP DM 39-A-20-10-18-00A-691A-A and with reference to Figure 32 Wiring Diagram, mark wires as R12125A24-S(WH) and R12125A24-S(BL) by means of marker sleeves.
- 7.20.71 With reference to Figures 19 and 20 and Figure 32 Wiring Diagram, cut n°1 wire P/N A556A-T24 of adequate length and lay down between diode CR2225 and connector A670P101.
- 7.20.72 In accordance with AMP DM 39-A-20-10-08-00A-622A-A and with reference to Figure 32 Wiring Diagram, crimp on wire n°1 electrical contact P/N A523A-A02 (CR2225 side) and n°1 electrical contact P/N FC7520D (A670P101 side) by means of proper crimping tool.
- 7.20.73 In accordance with AMP DM 39-A-20-10-18-00A-691A-A and with reference to Figure 32 Wiring Diagram, mark wire as R12123A24-S by means of marker sleeves.
- 7.20.74 With reference to Figure 19 and Figure 32 Wiring Diagram, cut n°1 wire P/N A556A-T24 of adequate length and lay down between diode CR2225 and splice SP21531.
- 7.20.75 In accordance with AMP DM 39-A-20-10-08-00A-622A-A and with reference to Figure 32 Wiring Diagram, crimp on wire n°1 electrical contact P/N A523A-A02 (CR2225 side) by means of proper crimping tool.
- 7.20.76 In accordance with AMP DM 39-A-20-10-18-00A-691A-A and with reference to Figure 32 Wiring Diagram, mark wire as R12124A24-S by means of marker sleeves.
- 7.20.77 With reference to Figure 32 Wiring Diagram, perform electrical connection between wires marked R12124A24-S and R12123A24-S by means of the diode assembly P/N AW001YD12 (CR2225).
- 7.20.78 With reference to Figure 19 and Figure 32 Wiring Diagram, cut n°1 wire P/N A556A-T24 of adequate length and lay down between connector S408P1 and splice SP21531.
- 7.20.79 In accordance with AMP DM 39-A-20-10-08-00A-622A-A and with reference to Figure 32 Wiring Diagram, crimp on wire n°1 electrical contact P/N M39029/22-192 (S408P1 side) by means of proper crimping tool.

- 7.20.80 In accordance with AMP DM 39-A-20-10-18-00A-691A-A and with reference to Figure 32 Wiring Diagram, mark wire as R12124C24-S by means of marker sleeves.
- 7.20.81 With reference to Figure 19 and Figure 32 Wiring Diagram, cut n°1 wire P/N A556A-T24 of adequate length and lay down between diode CR2227 and splice SP21531.
- 7.20.82 In accordance with AMP DM 39-A-20-10-08-00A-622A-A and with reference to Figure 32 Wiring Diagram, crimp on wire n°1 electrical contact P/N A523A-A02 (CR2227 side) by means of proper crimping tool.
- 7.20.83 In accordance with AMP DM 39-A-20-10-18-00A-691A-A and with reference to Figure 32 Wiring Diagram, mark wire as R12124B24-S by means of marker sleeves.
- 7.20.84 With reference to Figures 32 Wiring Diagram, perform electrical connection between wires marked as R12124B24-S, R12124C24-S and R12124A24-S by means of splice P/N M81824/1-1 (SP21531).
- 7.20.85 With reference to Figures 18 and 19 and Figure 32 Wiring Diagram, cut n°1 wire P/N A556A-T24 of adequate length and lay down between diode CR2227 and terminal board TB2297-1.
- 7.20.86 In accordance with AMP DM 39-A-20-10-08-00A-622A-A and with reference to Figure 32 Wiring Diagram, crimp on wire n°1 electrical contact P/N A523A-A02 (CR2227 side) and n°1 electrical contact P/N A523A-A01 (TB2297-1 side) by means of proper crimping tool.
- 7.20.87 In accordance with AMP DM 39-A-20-10-18-00A-691A-A and with reference to Figure 32 Wiring Diagram, mark wire as R12128A24-S by means of marker sleeves.
- 7.20.88 With reference to Figure 32 Wiring Diagram, perform electrical connection between wires marked as R12128A24-S and R12124B24-S by means of the diode assembly P/N AW001YD12 (CR2227).
- 7.20.89 With reference to Figures 19 and 20 and Figure 32 Wiring Diagram, cut n°1 wire P/N A556A-T24 of adequate length and lay down between connector S408P1 and connector A670P102.
- 7.20.90 In accordance with AMP DM 39-A-20-10-08-00A-622A-A and with reference to Figure 32 Wiring Diagram, crimp on wire n°1 electrical contact P/N M39029/22-192 (S408P1 side) and n°1 electrical contact P/N FC7520D (A670P102 side) by means of proper crimping tool.

- 7.20.91 In accordance with AMP DM 39-A-20-10-18-00A-691A-A and with reference to Figure 32 Wiring Diagram, mark wire as R12126A24-S by means of marker sleeves.
- 7.20.92 With reference to Figure 19 and Figure 32 Wiring Diagram, cut n°1 wire P/N A556A-T24 of adequate length and lay down between connector S408P1 and connector HT128J1.
- 7.20.93 In accordance with AMP DM 39-A-20-10-08-00A-622A-A and with reference to Figure 32 Wiring Diagram, crimp on wire n°1 electrical contact P/N M39029/22-192 (S408P1 side) and n°1 electrical contact P/N M39029/5-115 (HT128J1 side) by means of proper crimping tool.
- 7.20.94 In accordance with AMP DM 39-A-20-10-18-00A-691A-A and with reference to Figure 32 Wiring Diagram, mark wire as R12127A24-S by means of marker sleeves.
- 7.20.95 With reference to Figures 19 and 20 and Figure 33 Wiring Diagram, cut n°2 wires P/N A561A-T2-24 of adequate length and lay down between connector HT129J1 and connector A670P101.
- 7.20.96 In accordance with AMP DM 39-A-20-10-08-00A-622A-A and with reference to Figure 33 Wiring Diagram, crimp on wires n°2 electrical contacts P/N M39029/5-115 (HT129J1 side) and n°2 electrical contacts P/N FC7520D (A670P101 side) by means of proper crimping tool.
- 7.20.97 In accordance with AMP DM 39-A-20-10-18-00A-691A-A and with reference to Figure 33 Wiring Diagram, mark wires as R12133A24-S(WH) and R12133A24-S(BL) by means of marker sleeves.
- 7.20.98 With reference to Figure 20 and Figure 33 Wiring Diagram, cut n°1 wire P/N A556A-T22 of adequate length and lay down between connector A670P101 and connector A670P101.
- 7.20.99 In accordance with AMP DM 39-A-20-10-08-00A-622A-A and with reference to Figure 33 Wiring Diagram, crimp on wire on pin "32" n°1 electrical contact P/N FC7520D (A670P101 side) by means of proper crimping tool.
- 7.20.100 In accordance with AMP DM 39-A-20-10-18-00A-691A-A and with reference to Figure 33 Wiring Diagram, mark wire as R12134A22-S by means of marker sleeves.

- 7.20.101 With reference to Figures 19 and 20 and Figure 33 Wiring Diagram, cut n°2 wires P/N A561A-T2-24 of adequate length and lay down between connector HT129J1 and connector A670P102.
- 7.20.102 In accordance with AMP DM 39-A-20-10-08-00A-622A-A and with reference to Figure 33 Wiring Diagram, crimp on wires n°2 electrical contacts P/N M39029/5-115 (HT129J1 side) and n°2 electrical contacts P/N FC7520D (A670P102 side) by means of proper crimping tool.
- 7.20.103 In accordance with AMP DM 39-A-20-10-18-00A-691A-A and with reference to Figure 33 Wiring Diagram, mark wires as R12137A24-S(WH) and R12137A24-S(BL) by means of marker sleeves.
- 7.20.104 With reference to Figures 19 and 20 and Figure 33 Wiring Diagram, cut n°1 wire P/N A556A-T24 of adequate length and lay down between diode CR2229 and connector A670P101.
- 7.20.105 In accordance with AMP DM 39-A-20-10-08-00A-622A-A and with reference to Figure 33 Wiring Diagram, crimp on wire n°1 electrical contact P/N A523A-A02 (CR2229 side) and n°1 electrical contact P/N FC7520D (A670P101 side) by means of proper crimping tool.
- 7.20.106 In accordance with AMP DM 39-A-20-10-18-00A-691A-A and with reference to Figure 33 Wiring Diagram, mark wire as R12135A24-S by means of marker sleeves.
- 7.20.107 With reference to Figure 19 and Figure 33 Wiring Diagram, cut n°1 wire P/N A556A-T24 of adequate length and lay down between diode CR2229 and splice SP21536.
- 7.20.108 In accordance with AMP DM 39-A-20-10-08-00A-622A-A and with reference to Figure 33 Wiring Diagram, crimp on wire n°1 electrical contact P/N A523A-A02 (CR2229 side) by means of proper crimping tool.
- 7.20.109 In accordance with AMP DM 39-A-20-10-18-00A-691A-A and with reference to Figure 33 Wiring Diagram, mark wire as R12136A24-S by means of marker sleeves.
- 7.20.110 With reference to Figure 33 Wiring Diagram perform electrical connection between wires marked as R12136A24-S and R12135A24-S by means of diode assembly P/N AW001YD12 (CR229).

- 7.20.111 With reference to Figure 19 and Figure 33 Wiring Diagram, cut n°1 wire P/N A556A-T24 of adequate length and lay down between connector S409P1 and splice SP21536.
- 7.20.112 In accordance with AMP DM 39-A-20-10-08-00A-622A-A and with reference to Figure 33 Wiring Diagram, crimp on wire n°1 electrical contact P/N M39029/22-192 (S409P1 side) by means of proper crimping tool.
- 7.20.113 In accordance with AMP DM 39-A-20-10-18-00A-691A-A and with reference to Figure 33 Wiring Diagram, mark wire as R12136C24-S by means of marker sleeves.
- 7.20.114 With reference to Figure 19 and Figure 33 Wiring Diagram, cut n°1 wire P/N A556A-T24 of adequate length and lay down between diode CR2231 and splice SP21536.
- 7.20.115 In accordance with AMP DM 39-A-20-10-08-00A-622A-A and with reference to Figure 33 Wiring Diagram, crimp on wire n°1 electrical contact P/N A523A-A02 (CR2231 side) by means of proper crimping tool.
- 7.20.116 In accordance with AMP DM 39-A-20-10-18-00A-691A-A and with reference to Figure 33 Wiring Diagram, mark wire as R12136B24-S by means of marker sleeves.
- 7.20.117 With reference to Figure 33 Wiring Diagram, perform electrical connection between wires marked as R12136B24-S, R12136C24-S and R12136A24-S by means of splice P/N M81824/1-1 (SP21536).
- 7.20.118 With reference to Figures 18 and 19 and Figure 33 Wiring Diagram, cut n°1 wire P/N A556A-T24 of adequate length and lay down between diode CR2231 and terminal board TB2297-1.
- 7.20.119 In accordance with AMP DM 39-A-20-10-08-00A-622A-A and with reference to Figure 33 Wiring Diagram, crimp on wire n°1 electrical contact P/N A523A-A02 (CR2231 side) and n°1 electrical contact P/N A523A-A01 (TB2297-1 side) by means of proper crimping tool.
- 7.20.120 In accordance with AMP DM 39-A-20-10-18-00A-691A-A and with reference to Figure 33 Wiring Diagram, mark wire as R12159A24-S by means of marker sleeves.
- 7.20.121 With reference to Figure 33 Wiring Diagram, perform electrical connection between wires marked as R12159A24-S and R12136B24-S by means of the diode assembly P/N AW001YD12 (CR2231).

- 7.20.122 With reference to Figures 19 and 20 and Figure 33 Wiring Diagram, cut n°1 wire P/N A556A-T24 of adequate length and lay down between connector S409P1 and connector A670P102.
- 7.20.123 In accordance with AMP DM 39-A-20-10-08-00A-622A-A and with reference to Figure 33 Wiring Diagram, crimp on wire n°1 electrical contact P/N M39029/22-192 (S409P1 side) and n°1 electrical contact P/N FC7520D (A670P102 side) by means of proper crimping tool.
- 7.20.124 In accordance with AMP DM 39-A-20-10-18-00A-691A-A and with reference to Figure 33 Wiring Diagram, mark wire as R12138A24-S by means of marker sleeves.
- 7.20.125 With reference to Figure 19 and Figure 33 Wiring Diagram, cut n°1 wire P/N A556A-T24 of adequate length and lay down between connector S409P1 and connector HT129J1.
- 7.20.126 In accordance with AMP DM 39-A-20-10-08-00A-622A-A and with reference to Figure 33 Wiring Diagram, crimp on wire n°1 electrical contact P/N M39029/22-192 (S409P1 side) and n°1 electrical contact P/N M39029/5-115 (HT129J1 side) by means of proper crimping tool.
- 7.20.127 In accordance with AMP DM 39-A-20-10-18-00A-691A-A and with reference to Figure 33 Wiring Diagram, mark wire as R12136D24-S by means of marker sleeves.
- 7.20.128 With reference to Figures 17 and 19 and Figure 35 Wiring Diagram, cut n°1 wire P/N A561A-T2-22 of adequate length and lay down between connector PL60P2 and connector J2441.
- 7.20.129 In accordance with AMP DM 39-A-20-10-08-00A-622A-A and with reference to Figure 35 Wiring Diagram, crimp on wire n°1 electrical contact P/N M39029/57-354 (PL60P2 side) and n°1 electrical contact P/N 350690-3 (J2441 side) by means of proper crimping tool.
- 7.20.130 In accordance with AMP DM 39-A-20-10-18-00A-691A-A and with reference to Figure 35 Wiring Diagram, mark wire as R12150A22-S(WH) by means of marker sleeves.
- 7.20.131 With reference to Figures 17 and 19 and Figure 35 Wiring Diagram, cut n°1 wire P/N A561A-T2-22 of adequate length and lay down between connector PL60P2 and splice SP21540.
- 7.20.132 In accordance with AMP DM 39-A-20-10-08-00A-622A-A and with reference to Figure 35 Wiring Diagram, crimp on wire n°1 electrical

- contact P/N M39029/57-354 (PL60P2 side) by means of proper crimping tool.
- 7.20.133 In accordance with AMP DM 39-A-20-10-18-00A-691A-A and with reference to Figure 35 Wiring Diagram, mark wire as R12150A22-S(BL) by means of marker sleeves.
- 7.20.134 With reference to Figure 19 and Figure 35 Wiring Diagram, cut n°1 wire P/N A556A-T22 of adequate length and lay down between splice SP21541 and splice SP21540.
- 7.20.135 In accordance with AMP DM 39-A-20-10-18-00A-691A-A and with reference to Figure 35 Wiring Diagram, mark wire as R12151B22-S by means of marker sleeves.
- 7.20.136 With reference to Figure 19 and Figure 35 Wiring Diagram, cut n°1 wire P/N A556A-T22 of adequate length and lay down between splice SP21540 and connector J2441.
- 7.20.137 In accordance with AMP DM 39-A-20-10-08-00A-622A-A and with reference to Figure 35 Wiring Diagram, crimp on wire n°1 electrical contact P/N 350690-3 (J2441 side) by means of proper crimping tool.
- 7.20.138 In accordance with AMP DM 39-A-20-10-18-00A-691A-A and with reference to Figure 35 Wiring Diagram, mark wire as R12151A22-S by means of marker sleeves.
- 7.20.139 With reference to Figure 19 and Figure 35 Wiring Diagram, cut n°1 wire P/N A556A-T22 of adequate length and lay down between splice SP21541 and splice SP21540.
- 7.20.140 In accordance with AMP DM 39-A-20-10-18-00A-691A-A and with reference to Figure 35 Wiring Diagram, mark wire as R12151C22-S by means of marker sleeves.
- 7.20.141 With reference to Figure 35 Wiring Diagram, perform electrical connection between wires marked as R12151C22-S, R12151A22-S, R12151B22-S and R12150A22-S(BL) by means of splice P/N M81824/1-1 (SP21540).
- 7.20.142 With reference to Figures 18 and 19 and Figure 35 Wiring Diagram, cut n°1 wire P/N A556A-T22 of adequate length and lay down between splice SP21541 and terminal board TB295.
- 7.20.143 In accordance with AMP DM 39-A-20-10-08-00A-622A-A and with reference to Figure 35 Wiring Diagram, crimp on wire n°1 electrical contact P/N A523A-A05 (TB295 side) by means of proper crimping tool.

- 7.20.144 In accordance with AMP DM 39-A-20-10-18-00A-691A-A and with reference to Figure 35 Wiring Diagram, mark wire as R12151E22N-S by means of marker sleeves.
- 7.20.145 With reference to Figures 18 and 19 and Figure 35 Wiring Diagram, cut n°1 wire P/N A561A-T2-22 of adequate length and lay down between splice SP21541 and junction module TB2211-2.
- 7.20.146 In accordance with AMP DM 39-A-20-10-08-00A-622A-A and with reference to Figure 35 Wiring Diagram, crimp on wire n°1 electrical contact P/N A523A-A01 (TB2211-2 side) by means of proper crimping tool.
- 7.20.147 In accordance with AMP DM 39-A-20-10-18-00A-691A-A and with reference to Figure 35 Wiring Diagram, mark wire as R12152B22-S(BL) by means of marker sleeves.
- 7.20.148 With reference to Figure 19 and Figure 35 Wiring Diagram, cut n°1 wire P/N A556A-T22 of adequate length and lay down between splice SP21541 and connector J2441.
- 7.20.149 In accordance with AMP DM 39-A-20-10-08-00A-622A-A and with reference to Figure 35 Wiring Diagram, crimp on wire n°1 electrical contact P/N 350690-3 (J2441 side) by means of proper crimping tool.
- 7.20.150 In accordance with AMP DM 39-A-20-10-18-00A-691A-A and with reference to Figure 35 Wiring Diagram, mark wire as R12151D22-S by means of marker sleeves.
- 7.20.151 With reference to Figure 35 Wiring Diagram, perform electrical connection between wires marked as R12151C22-S, R12151E22N-S, R12152B22-S(BL), and R12151D22-S by means of splice P/N M81824/1-1 (SP21541).
- 7.20.152 With reference to Figures 18 and 19 and Figure 35 Wiring Diagram, cut n°1 wire P/N A561A-T2-22 of adequate length and lay down between junction module TB2211-2 and connector J2441.
- 7.20.153 In accordance with AMP DM 39-A-20-10-08-00A-622A-A and with reference to Figure 35 Wiring Diagram, crimp on wire n°1 electrical contact P/N 350690-3 (J2441 side) n°1 electrical contact P/N A523A-A01 (TB2211-2 side) and by means of proper crimping tool.

- 7.20.154 In accordance with AMP DM 39-A-20-10-18-00A-691A-A and with reference to Figure 35 Wiring Diagram, mark wire as R12152B22-S by means of marker sleeves.
- 7.20.155 With reference to Figure 18 and Figure 35 Wiring Diagram, cut n°2 wires P/N A556A-T22 of adequate length and lay down between junction module TB2211-2 and junction module TB2211-2.
- 7.20.156 In accordance with AMP DM 39-A-20-10-08-00A-622A-A and with reference to Figure 35 Wiring Diagram, crimp on wires pin “s” and pin “r” n°2 electrical contacts P/N A523A-A01 (TB2211-2 side) by means of proper crimping tool.
- 7.20.157 In accordance with AMP DM 39-A-20-10-18-00A-691A-A and with reference to Figure 35 Wiring Diagram, mark wires as R12154B22-S and R12154A22-S by means of marker sleeves.
- 7.20.158 With reference to Figures 17 and 18 and Figure 35 Wiring Diagram, cut n°2 wires P/N A561A-T2-22 of adequate length and lay down between junction module TB2211-2 and connector PL60P2.
- 7.20.159 In accordance with AMP DM 39-A-20-10-08-00A-622A-A and with reference to Figure 35 Wiring Diagram, crimp on wires n°2 electrical contacts P/N M39029/57-354 (PL60P2 side) n°2 electrical contacts P/N A523A-A01 (TB2211-2 side) and by means of proper crimping tool.
- 7.20.160 In accordance with AMP DM 39-A-20-10-18-00A-691A-A and with reference to Figure 35 Wiring Diagram, mark wires as R12152A22-S(WH) and R12152A22-S(BL) by means of marker sleeves.
- 7.20.161 With reference to Figure 17 and Figure 35 Wiring Diagram, cut n°1 wire P/N A556A-T22 of adequate length and lay down between connector PL60P2 and connector PL60P2.
- 7.20.162 In accordance with AMP DM 39-A-20-10-08-00A-622A-A and with reference to Figure 35 Wiring Diagram, crimp on wire on pin “VSER” n°1 electrical contact P/N MS25036-148 (PL60P2 side) by means of proper crimping tool.
- 7.20.163 In accordance with AMP DM 39-A-20-10-18-00A-691A-A and with reference to Figure 35 Wiring Diagram, mark wire as R12153A22N-S by means of marker sleeves.

- 7.20.164 With reference to Figure 20 and Figure 34 Wiring Diagram, cut n°8 wires P/N A561A-T2-22 of adequate length and lay down between connector A670P101 and connector A670P102.
- 7.20.165 In accordance with AMP DM 39-A-20-10-08-00A-622A-A and with reference to Figure 34 Wiring Diagram, crimp on wires n°8 electrical contacts P/N FC7520D (A670P101 side) and n°8 electrical contacts P/N FC7520D (A670P102 side) by means of proper crimping tool.
- 7.20.166 In accordance with AMP DM 39-A-20-10-18-00A-691A-A and with reference to Figure 34 Wiring Diagram, mark wires as R12142A24-S white and blue, R12144A24-S white and blue, R12146A24-S white and blue and R12148A24-S white and blue by means of marker sleeves.
- 7.20.167 With reference to Figure 20 and Figure 34 Wiring Diagram, cut n°4 wires P/N A556A-T22 of adequate length and lay down between connector A670P101 and connector A670P101.
- 7.20.168 In accordance with AMP DM 39-A-20-10-08-00A-622A-A and with reference to Figure 34 Wiring Diagram, crimp on wires on pin "22", "24", "26" and "28" n°4 electrical contacts P/N FC7520D (A670P101 side).
- 7.20.169 In accordance with AMP DM 39-A-20-10-18-00A-691A-A and with reference to Figure 34 Wiring Diagram, mark wires as R12143A22-S, R12145A22-S, R12147A22-S and R12149A22-S by means of marker sleeves.
- 7.20.170 With reference to Figures 16 and 17 and Figure 38 Wiring Diagram, cut n°1 wire P/N A556A-T22 of adequate length and lay down between connector J133 and connector A189P2.
- 7.20.171 In accordance with AMP DM 39-A-20-10-08-00A-622A-A and with reference to Figure 38 Wiring Diagram, crimp on wire n°1 electrical contact P/N M39029/56-348 (J133 side) n°1 electrical contact P/N M39029/57-357 (A189 P2 side) and by means of proper crimping tool.
- 7.20.172 In accordance with AMP DM 39-A-20-10-18-00A-691A-A and with reference to Figure 38 Wiring Diagram, mark wire as R12158A22-S by means of marker sleeves.
- 7.20.173 With reference to Figure 38 Wiring Diagram, remove n°2 wires marked as "R1846A24-S(WH)" and "R1846A24-S(bl)" between P205 and A189P1 of C/A B2A299.

- 7.20.174 With reference to Figures 17 and 18 and Figure 38 Wiring Diagram, cut n°2 wires P/N A561A-T2-24 of adequate length and lay down between connector P205 and connector A189P1.
- 7.20.175 In accordance with AMP DM 39-A-20-10-08-00A-622A-A and with reference to Figure 38 Wiring Diagram, crimp on wires n°2 electrical contacts P/N M39029/58-363 (P205 side) n°2 electrical contacts P/N M39029/57-357 (A189P1 side) and by means of proper crimping tool.
- 7.20.176 In accordance with AMP DM 39-A-20-10-18-00A-691A-A and with reference to Figure 38 Wiring Diagram, mark wires as R12157A24-S(WH) and R12157A24-S(BL) by means of marker sleeves.
- 7.20.177 In accordance with AMP DM 39-A-20-10-18-00A-691A-A and Figure 38 Wiring Diagram, mark the cable assembly so obtained as B2L115 by means of marker sleeves.
- 7.20.178 With reference to Figures 31 thru 35 and 38 Wiring Diagram, apply n°32 insulation sleeves P/N M23053/8-004-C on the wires.
- 7.20.179 With reference to Figures 31 thru 35 Wiring Diagram, apply n°18 ferule P/N A590A02 on the end of the wires.
- 7.21 With reference to Figures 36 and 39 Wiring Diagram, remove, reuse or stowed all connections on both sides.
- 7.22 With reference to Figures 19 and Figure 35 Wiring Diagram, install the audio connector assy P/N 3G2350A10231 and connect the connector P2441 to connector J2441.
- 7.23 With reference to Figure 19, apply the decal P/N ED300J2443 and the decal P/N ED300PAX.

NOTE

Use the edging P/N A236A on edges which are liable to cause damage to cable assemblies or where abrasion may occur.

NOTE

Install the tubing braided P/N A582A where protection against chafing and prevention of contact with structure may occur, but the tubing protection is not substitute for good routing practice.

- 7.24 With reference to Figures 15 thru 20, lay down the following cable assemblies on

the existing routes unless otherwise indicated on the figures:

- 3G9A01A68201 audio customization upgrade C/A (A1A682);
- 3G9A02A61901 audio customization upgrade C/A (A2A619);
- 3G9B01L12001 audio customization upgrade C/A (B1L120);
- 3G9B02B74601 audio customization upgrade C/A (B2B746);
- 3G9B02L11501 audio customization upgrade C/A (B2L115).

- 7.25 With reference to Figures 15 thru 20, secure the cable assemblies laid down at previous step by means of existing hardware and lacing cord.
- 7.26 With reference to Figure 17 View Looking cabin window LH side from STA 3120 to STA 3900, install the clamp P/N AW001CB03H on C/A B1A433 and the clamp P/N AW001CB10H on C/A B2A301, C/A B2A299 and C/A B2L115 by means of the spacer P/N NAS43DD3-50N, the nut P/N MS21043L3 and the washer P/N NAS1149D0332J.
- 7.27 With reference to Figure 17 View Looking cabin window LH side from STA 3120 to STA 3900, install the clamp P/N AW001CB07H on C/A B2A958, C/A B3A493, C/A B1A433 and C/A B1A811 and the clamp P/N AW001CB17H on C/A B2A299, C/A B2A679, C/A B2A301 and C/A B2L115 by means of the spacer P/N NAS43DD3-19N, the nut P/N MS21043L3 and the washer P/N NAS1149D0332J.
- 7.28 With reference to Figure 20 View Looking down secondary avionic bay, install the clamp P/N AW001CB06H on C/A B2L115 and the clamp P/N AW001CB03H on C/A B1L120 by means of the spacer P/N NAS43DD3-45N, the spacer P/N NAS43DD3-40N, the nut P/N MS21043L3 and the washer P/N NAS1149D0332J.
- 7.29 With reference to Figure 20 View Looking down secondary avionic bay, install the clamp P/N AW001CB05H on C/A B2L115 and the clamp P/N AW001CB04H on C/A B1L120 and C/A B1L121 by means of existing spacer P/N NAS43DD3-55N, the spacer P/N NAS43DD3-35N, existing nut P/N MS21043L3 and existing washer P/N NAS1149D0332J.
8. In accordance with AMP DM 39-A-06-41-00-00A-010A-A and with reference to Figures 21 thru 25 and Figure 40 Wiring Diagram, gain access to the area affected by the installation and perform MLT cabin CTL PNLs (MCCP) elect prov P/N 3G4620A00611 as described in the following procedure:
- 8.1 With reference to Figure 25, perform the mission bus RH structural provision P/N 3G5310A63413 as described in the following procedure:

- 8.1.1 With reference to Figure 25 Section B-B and Section C-C, perform the indicated cut-out thru the lower middle panel P/N 3P5333A37231.
- 8.1.2 With reference to Figure 25 Section C-C, fill the cut-out edges of lower middle panel P/N 3P5333A37231 with adhesive EA934NA (C057).
- 8.1.3 With reference to Figure 25 Section A-A and Section B-B, install the bracket P/N 3G5315A68151 in the indicated position on the right wall P/N 3P5333A19151 by means of n°3 rivets P/N NAS9301B-4-02.

NOTE

Perform the step 8.2 only when the single hoist Goodrich elect provision is not installed, otherwise skip to step 8.3.

- 8.2 With reference to Figure 24 Detail N, install the stud P/N A366A3E16C in the indicated position.
- 8.3 With reference to Figures 22 thru 24 and Figure 40 Wiring Diagram, assemble the utility CB panel RH C/A P/N 3G9E01C24330 (E1C243) as described in the following procedure:
 - 8.3.1 With reference to Figures 22 and 23 and Figure 40 Wiring Diagram, cut n°1 wire P/N A556A-T18 of adequate length and lay down between connector PL1J2 and circuit breaker CB647.
 - 8.3.2 In accordance with AMP DM 39-A-20-10-08-00A-622A-A and with reference to Figure 40 Wiring Diagram, crimp on wire n°1 electrical contact P/N M39029/56-352 (PL1J2 side) and n°1 terminal lug P/N MS25036-149 (CB647 side) by means of proper crimping tool.
 - 8.3.3 In accordance with AMP DM 39-A-20-10-18-00A-691A-A and with reference to Figure 40 Wiring Diagram, mark wires as R412-18 by means of marker sleeves.
 - 8.3.4 With reference to Figures 22 and 23 and Figure 40 Wiring Diagram, cut n°1 wire P/N A556A-T20 of adequate length and lay down between connector PL1J3 and circuit breaker CB646.
 - 8.3.5 In accordance with AMP DM 39-A-20-10-08-00A-622A-A and with reference to Figure 40 Wiring Diagram, crimp on wire n°1 electrical contact P/N M39029/56-351 (PL1J3 side) and n°1 terminal lug P/N MS25036-149 (CB646 side) by means of proper crimping tool.
 - 8.3.6 In accordance with AMP DM 39-A-20-10-18-00A-691A-A and with reference to Figure 40 Wiring Diagram, mark wires as R411-20 by means of marker sleeves.

8.3.7 In accordance with AMP DM 39-A-20-10-18-00A-691A-A and Figure 40 Wiring Diagram, mark the cable assembly so obtained as E1C243 by means of marker sleeves.

NOTE

Use the edging P/N A236A on edges which are liable to cause damage to cable assemblies or where abrasion may occur.

NOTE

Install the tubing braided P/N A582A where protection against chafing and prevention of contact with structure may occur, but the tubing protection is not substitute for good routing practice.

- 8.4 With reference to Figures 21 thru 25, lay down the following cable assemblies on the existing routes unless otherwise indicated on the figures:
- 3G9B11B16712 utility CB panel RH C/A (B1B167);
 - 3G9B11B16814 utility CB panel RH C/A (B1B168);
 - 3G9E01C24330 utility CB panel RH C/A (E1C243).
- 8.5 With reference to Figures 21 thru 25, secure the cable assemblies laid down at previous step by means of existing hardware and lacing cord.
- 8.6 With reference to Figure 22 View looking floor area RH side from STA 1690 to STA 3120, remove and discard the screw P/N NAS1190E3P5AK.
- 8.7 With reference to Figure 22 View looking floor area RH side from STA 1690 to STA 3120, install the clamp P/N AW001CB02H on C/A E1C243 by means of the screw P/N NAS1190E3P14AK and the spacer P/N NAS43DD3-30N.
- 8.8 With reference to Figure 23 Section E-E, remove n°2 plugs P/N AS44417-B12 from the illuminated NVIS panel utility breaker.
- 8.9 With reference to Figure 23 Section E-E, remove existing illuminated NVIS panel utility breaker and retain existing hardware for later reuse.
- 8.10 With reference to Figure 23 Section E-E, install n°2 circuit breakers (CB646 and CB647) P/N MS3320-7-1/2 and n°2 lock rings P/N AW001YC01RED in the indicated positions.
- 8.11 In accordance with AMP DM 39-A-11-00-01-00A-720A-A and with reference to Figure 23 Detail F, apply the decal P/N ED300CB647 next to the circuit breaker CB647.
- 8.12 In accordance with AMP DM 39-A-11-00-01-00A-720A-A and with reference to Figure 23 Detail F, apply the decal P/N ED300CB646 next to the circuit breaker

- CB646.
- 8.13 With reference to Figure 23 Detail F, install the bus bar P/N 1035685-22 by means of the screw P/N NAS1802-3-7, the washer P/N NAS1149D0332K and the washer P/N MS35338-138.
- 8.14 With reference to Figure 23 Detail F, install the clamp P/N AW001CB02H on C/A E1C243 by means of the screw P/N NAS1802-3-12, the washer NAS1149D0332J and the spacer P/N NAS43DD3-25N.
- 8.15 With reference to Figure 24 View looking down cabin roof RH side, install the circuit breaker (CB377) P/N MS25244-50 and the lock ring P/N AW001YC01RED on the bracket P/N 3G5315A68151.
- 8.16 In accordance with AMP DM 39-A-11-00-01-00A-720A-A and with reference to Figure 24 View looking down cabin roof RH side, apply the decal P/N ED300CB377 next to the circuit breaker CB377.

NOTE

Perform the step 8.17 only when the single hoist Goodrich elect provision is not installed, otherwise skip to step 8.18.

- 8.17 With reference to Figure 24 Detail N, install the clamp P/N AW001CB05H on C/A B1B167 by means of the spacer P/N NAS43DD3-25N and the nut P/N MS21043-3.
- 8.18 With reference to Figures 22 and 23 and Figure 40 Wiring Diagram, perform electrical connection of C/A E1C243 to connector PL1J3, to connector PL1J2, to circuit breaker CB647 and to circuit breaker CB646.
- 8.19 With reference to Figure 24, View looking down cabin roof and O/H panel, install n°2 nipples P/N A584A02 on the C/A B1B167.
- 8.20 With reference to Figure 24 and Figure 40 Wiring Diagram, perform electrical connection of C/A B1B399 to connector A4 and to circuit breaker CB377. Use n°1 terminal lug P/N MS25036-116 (A4 side) and n°1 terminal lug P/N MS25036-115 (CB377 side).
- 8.21 With reference to Figure 24 and Figure 40 Wiring Diagram, perform electrical connection of C/A B1B401 to bus bar W42A and to circuit breaker CB377. Use n°2 terminal lugs P/N MS25036-115 (W42A and CB377 side).
- 8.22 With reference to Figure 23 Section E-E, install the illuminated NVIS panel utility breaker P/N 3G2490L04058 by means of existing hardware.
9. Perform a pin-to-pin continuity check of all the electrical connections made.

NOTE

Use the edging A236A on edges which are liable to cause damage to cable assemblies or where abrasion may occur.

NOTE

Use tubing braided A582A where need for protection against chafing and where contact with structure may occur.

10. With reference to Figures 48 thru 52 perform the PTT Hoist & Audio Customization Upgrade P/N 3G2350P06411 as described in the following steps:
 - 10.1 With reference to Figure 49 and Figure 51 Wiring Diagram, assemble the C/A B1R097 as described in the following procedure:
 - 10.1.1 With reference to Figure 51 Wiring Diagram WAS, disconnect the wire M95C22-G from the connector PL37P1.
 - 10.1.2 With reference to Figure 51 Wiring Diagram BECOMES, cut n°1 wire P/N A556A-T22 of adequate length and put it down between the splice P/N M81824/1-1 (SP5000-ME) and the diode P/N AW001YD03 (CR5002-ME).
 - 10.1.3 In accordance with AMP DM 39-A-20-10-08-00A-622A-A and with reference to Figure 51 Wiring Diagram BECOMES, perform the electrical connections between the splice SP270 and the diode CR5002-ME. Use n°1 electrical contact P/N A523A-A02.
 - 10.1.4 In accordance with AMP DM 39-A-20-10-08-00A-622A-A and with reference to Figure 51 Wiring Diagram BECOMES, perform the electrical connections between the splice SP5000-ME and the diode CR5002-ME. Use n°1 electrical contact P/N A523A-A02.
 - 10.1.5 In accordance with AMP DM 39-A-20-10-18-00A-691A-A and with reference to Figure 51 Wiring Diagram, mark the obtained wire as M95C22-G-ME by means of marker sleeve.
 - 10.1.6 With reference to Figure 51 Wiring Diagram BECOMES, cut n°1 wire P/N A556A-T22 of adequate length and put it down between the splice SP5000-ME and the connector PL37P1.
 - 10.1.7 In accordance with AMP DM 39-A-20-10-08-00A-622A-A and with reference to Figure 51 Wiring Diagram BECOMES, perform the electrical connections between the splice SP5000-ME and the connector PL37P1. Use n°1 electrical contact P/N M39029/56-348.

- 10.1.8 In accordance with AMP DM 39-A-20-10-18-00A-691A-A and with reference to Figure 51 Wiring Diagram BECOMES, mark the obtained wire as M95D22-G by means of marker sleeve.
- 10.1.9 With reference to Figure 51 Wiring Diagram BECOMES, cut n°1 wire P/N A556A-T22 of adequate length and put it down between the diode P/N AW001YD03 (CR5000-ME) and the splice SP5000-ME.
- 10.1.10 In accordance with AMP DM 39-A-20-10-08-00A-622A-A and with reference to Figure 51 Wiring Diagram BECOMES, perform the electrical connections between the diode CR5000-ME and the splice SP5000-ME. Use n°1 electrical contact P/N A523A-A02.
- 10.1.11 In accordance with AMP DM 39-A-20-10-18-00A-691A-A and with reference to Figure 51 Wiring Diagram BECOMES, mark the obtained wire as M95B22-G by means of marker sleeve.
- 10.1.12 With reference to Figure 51 Wiring Diagram BECOMES, cut n°1 wire P/N A556A-T22 of adequate length and put it down between the connector A212J1 and the diode CR5000-ME.
- 10.1.13 In accordance with AMP DM 39-A-20-10-08-00A-622A-A and with reference to Figure 51 Wiring Diagram BECOMES, perform the electrical connections between the connector A212J1 and the diode CR5000-ME. Use n°1 electrical contact P/N A523A-A02 and n°1 electrical contact P/N M39029/56-348.
- 10.1.14 In accordance with AMP DM 39-A-20-10-18-00A-691A-A and with reference to Figure 51 Wiring Diagram BECOMES, mark the obtained wire as M95F22-G by means of marker sleeve.
- 10.1.15 With reference to Figure 51 Wiring Diagram BECOMES, cut n°1 wire P/N A556A-T22 of adequate length and put it down between the connector A212J1 and the connector TB204P1.
- 10.1.16 In accordance with AMP DM 39-A-20-10-08-00A-622A-A and with reference to Figure 51 Wiring Diagram BECOMES, perform the electrical connections between the connector A212J1 and the connector TB204P1. Use n°1 electrical contact P/N M39029/56-351 and n°1 electrical contact P/N M39029/56-348.
- 10.1.17 In accordance with AMP DM 39-A-20-10-18-00A-691A-A and with reference to Figure 51 Wiring diagram BECOMES, mark the obtained wire as M95G22-G by means of marker sleeve.

- 10.1.18 With reference to Figure 49 secure the cable assembly previously laid down by means of existing hardware.
- 10.1.19 With reference to Figure 49 apply n°2 insulation sleeveings P/N A574A04-01 and n°1 insulation sleeving P/N A574A01-03.
- 10.2 With reference to Figure 50 and Figure 52 Wiring Diagram assemble the C/A B1L209 as described in the following procedure:
 - 10.2.1 With reference to Figure 50 View B, install the support P/N AW001CL001-N6 in the indicated position.
 - 10.2.2 With reference to Figure 52 Wiring Diagram, cut n°1 wire P/N A556A-T22 of adequate length and put it down between the connector J2441 and the fuse link P/N BJE86 (F2057).
 - 10.2.3 In accordance with AMP DM 39-A-20-10-08-00A-622A-A and with reference to Figure 52 Wiring Diagram, perform the electrical connections between the connector J2441 and the fuse link F2057. Use n°1 electrical contact P/N 350690-3 and n°1 electrical contact P/N A523A-A02.
 - 10.2.4 In accordance with AMP DM 39-A-20-10-18-00A-691A-A and with reference to Figure 52 Wiring Diagram, mark the obtained wire as R13221A22-G by means of marker sleeve.
 - 10.2.5 With reference to Figure 52 Wiring Diagram, cut n°1 wire P/N A556A-T22 of adequate length and put it down between the connector TB201P1 and the fuse link F2057.
 - 10.2.6 In accordance with AMP DM 39-A-20-10-08-00A-622A-A and with reference to Figure 52 Wiring Diagram, perform the electrical connections between the connector TB201P1 and the fuse link F2057. Use n°1 electrical contact P/N M39029/56-348 and n°1 electrical contact P/N A523A-A02.
 - 10.2.7 In accordance with AMP DM 39-A-20-10-18-00A-691A-A and with reference to Figure 52 Wiring Diagram, mark the obtained wire as R13220A22-G by means of marker sleeve.
 - 10.2.8 With reference to Figure 50 secure the cable assembly previously laid down by means of existing hardware.
- 10.3 Perform a pin-to-pin continuity check of all the electrical connections made.
- 11. In accordance with AMP DM 39-A-06-41-00-00A-010A-A and with reference to Figure 53 and Figures 54 thru 56 Wiring Diagram, gain access to the area affected by the installation and perform AUX O/H PNL retromod P/N 3G2460P01026 as described in the following

procedure:

- 11.1 With reference to Figure 53 Detail A, loose the three captive screws and remove the AUX breaker integrally light panel P/N 3G2490L04159 from the auxiliary circuit breaker-panel.
- 11.2 Loose the fixing hardware and lower the auxiliary circuit breaker-panel from the structure as far as the electrical cable will let.
- 11.3 With reference to Figure 53 Detail B, loose the eight captive screws and remove the switch integrally light panel P/N 3G2490V00958 from the electrical control panel.
- 11.4 Loose the fixing hardware and lower the electrical control panel from the structure as far as the electrical cable will let.
- 11.5 With reference to Figure 54 Wiring Diagram Was, remove the wire marked as "524-20" of the C/A E1C290 from the circuit breaker CB202 and the connector PL1J500.
- 11.6 With reference to Figure 54 Wiring Diagram Was, remove the wire marked as "532-16" of the C/A E1C290 from the circuit breaker CB576 and the switch S352.
- 11.7 With reference to Figure 54 Wiring Diagram Was, disconnect the wire marked as "1001-20" of the C/A E1C289 from the pin "2" of the switch S137.
- 11.8 With reference to Figure 54 Wiring Diagram Was, remove the wire marked as "525-20" of the C/A E1C290 from the connector PL1J1 and the connector PL1J500.
- 11.9 With reference to Figure 54 Wiring Diagram Was, remove the wire marked as "533-16" of the C/A E1C290 from the connector PL1J2 and the switch S352.
- 11.10 With reference to Figure 54 Wiring Diagram Was, disconnect the wire marked as "1002-20" of the C/A E1C289 from the pin "3" of the switch S137.
- 11.11 With reference to Figure 55 Wiring Diagram Becomes, cut n°1 electrical wire P/N A556A-T20 and lay down between the circuit breaker CB202 and the switch S137.
- 11.12 In accordance with AMP DM 39-A-20-10-08-00A-622A-A and with reference to Figure 55 Wiring Diagram Becomes, perform electrical connections of the wire between the circuit breaker CB202 and the switch S137.
- 11.13 In accordance with AMP DM 39-A-20-10-18-00A-691A-A and with reference to Figure 55 Wiring Diagram Becomes, mark the obtained wire as "524-20" (C/A E1C290) by means of marker sleeve.
- 11.14 With reference to Figure 55 Wiring Diagram Becomes, cut n°1 electrical wire P/N A556A-T20 and lay down between the circuit breaker CB576 and the

connector PL1J500.

- 11.15 In accordance with AMP DM 39-A-20-10-08-00A-622A-A and with reference to Figure 55 Wiring Diagram Becomes, perform electrical connections of the wire between the circuit breaker CB576 and the connector PL1J500.
- 11.16 In accordance with AMP DM 39-A-20-10-18-00A-691A-A and with reference to Figure 55 Wiring Diagram Becomes, mark the obtained wire as "532-20" (C/A E1C290) by means of marker sleeve.
- 11.17 With reference to Figure 55 Wiring Diagram Becomes, cut n°1 electrical wire P/N A556A-T20 and lay down between the connector PL1J1 and the switch S137.
- 11.18 In accordance with AMP DM 39-A-20-10-08-00A-622A-A and with reference to Figure 55 Wiring Diagram Becomes, perform electrical connections of the wire between the connector PL1J1 and the switch S137.
- 11.19 In accordance with AMP DM 39-A-20-10-18-00A-691A-A and with reference to Figure 55 Wiring Diagram Becomes, mark the obtained wire as "525-20" by means of marker sleeve.
- 11.20 With reference to Figure 55 Wiring Diagram Becomes, cut n°1 electrical wire P/N A556A-T20 and lay down between the connector PL1J2 and the connector PL1J500.
- 11.21 In accordance with AMP DM 39-A-20-10-08-00A-622A-A and with reference to Figure 55 Wiring Diagram Becomes, perform electrical connections of the wire between the connector PL1J2 and the connector PL1J500.
- 11.22 In accordance with AMP DM 39-A-20-10-18-00A-691A-A and with reference to Figure 55 Wiring Diagram Becomes, mark the obtained wire as "533-20" by means of marker sleeve.
- 11.23 With reference to Figure 55 Wiring Diagram Becomes, connect the existing wire marked as "1001-20" of the C/A E1C289 to the pin "2" of the switch S352.
- 11.24 With reference to Figure 55 Wiring Diagram Becomes, connect the wire existing marked as "1002-20" of the C/A E1C289 to the pin "3" of the switch S352.
- 11.25 With reference to Figure 53 Detail A, remove the decal P/N ED300S352 near the switch S352.
- 11.26 With reference to Figure 53 Detail B, remove the decal P/N ED300S137 near the switch S137.
- 11.27 In accordance with AMP DM 39-A-11-00-01-00A-720A-A and with reference to Figure 53 Detail A, install the decal P/N ED300S137 near the switch S137.
- 11.28 In accordance with AMP DM 39-A-11-00-01-00A-720A-A and with reference to Figure 53 Detail B, install the decal P/N ED300S352 near the switch S352.

- 11.29 With reference to Figure 56 Wiring Diagram Was, disconnect the wire marked "341-20" (E1C201) from the pin "2" of the switch S1 and disconnect the wire marked "342-20" (E1C201) from the pin "3" of the switch S1.
- 11.30 With reference to Figure 53 Detail B and Figure 56 Wiring Diagram Was, remove the switch (S1) P/N MS27722-23 and the decal P/N ED300S1.
- 11.31 With reference to Figure 53 Detail B, install in the same position of the removed switch the plug P/N AS44417-B12.
- 11.32 With reference to Figure 56 Wiring Diagram Becomes, install the cap (CE508) P/N A583A2610W on the end of the wire marked "341-20" (E1C201) and install the cap (CE509) P/N A583A2610W on the end of the wire marked "342-20" (E1C201).
- 11.33 Re-install the fixing hardware previously removed and fix the auxiliary circuit breaker-panel to the structure. In accordance with AMP DM 39-A-20-00-00-00A-711A-A, tighten the five screws to the standard torque value.
- 11.34 With reference to Figure 53 Detail A, install the auxiliary circuit breaker integrally light panel P/N 3G2490L05769 to the auxiliary circuit breaker-panel by means of the three captive screws.
- 11.35 In accordance with AMP DM 39-A-20-00-00-00A-711A-A, tighten the three captive screws to the standard torque value.
- 11.36 Re-install the fixing hardware previously removed and fix the electrical control panel to the structure. In accordance with AMP DM 39-A-20-00-00-00A-711A-A, tighten the eleven screws to the standard torque value.
- 11.37 With reference to Figure 53 Detail B, install the switch integrally light panel P/N 3G2491L00162 to the electrical control panel by means of the eight captive screws.
- 11.38 In accordance with AMP DM 39-A-20-00-00-00A-711A-A, tighten the eight captive screws to the standard torque value.
- 11.39 Perform a pin-to-pin continuity check of all the electrical connections made.
12. In accordance with AMP DM 39-A-46-20-00-00A-750A-A, load the option file P/N DM60004869-60629.
13. In accordance with Annex A, Annex B, Annex C, perform the operational tests.
14. In accordance with weight and balance changes, update the Chart A (see Rotorcraft Flight Manual, Part II, section 6).
15. Return the helicopter to flight configuration and record for compliance with this Service Bulletin on the helicopter logbook.
16. Send the attached compliance form to the following mail box:

engineering.support.lhd@leonardocompany.com

As an alternative, gain access to My Communications section on Leonardo WebPortal and compile the “Service Bulletin Application Communication”.

AUDIO CUST UPGRADE DUBAI STRUCT PROV
3G5311A41211

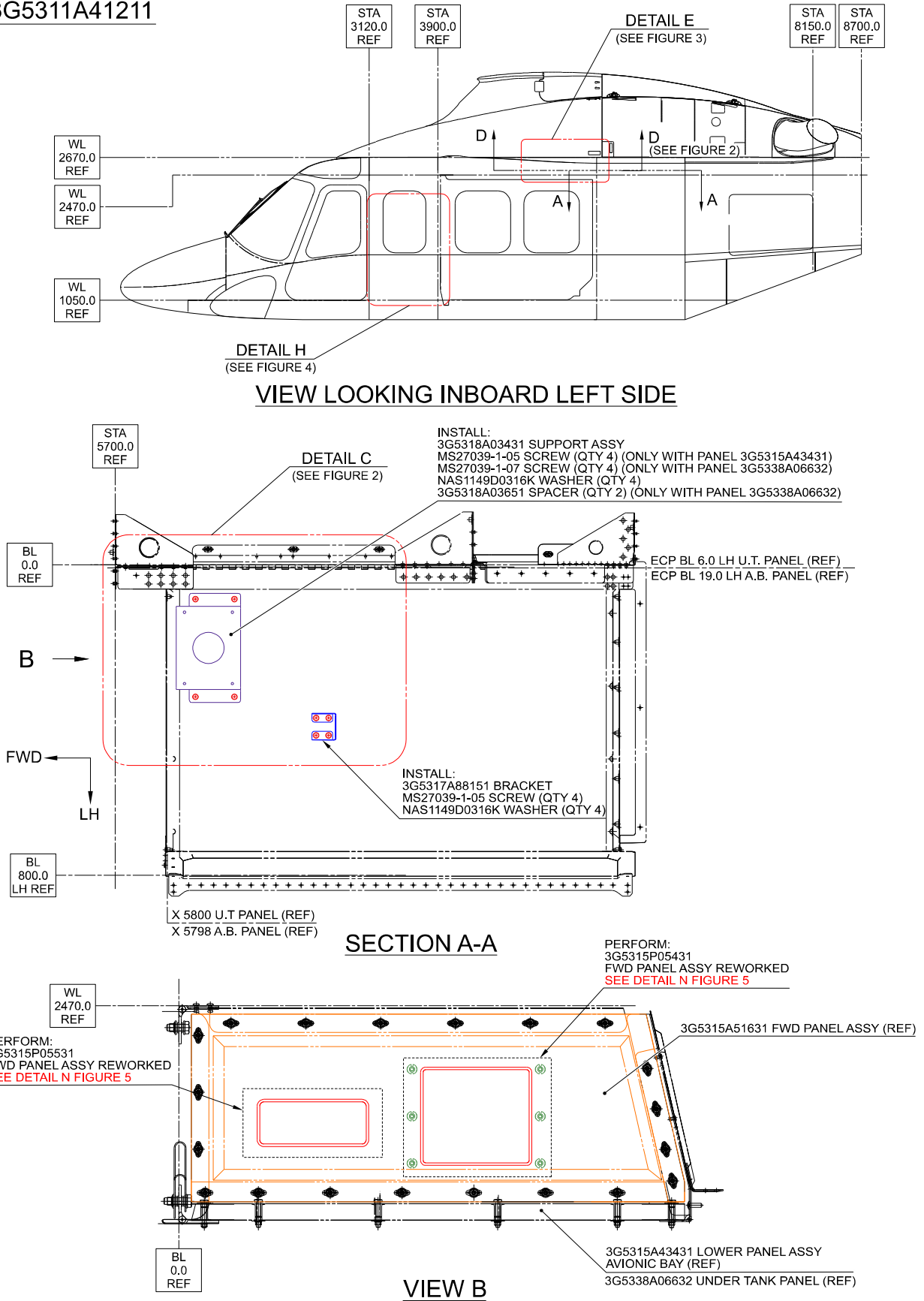
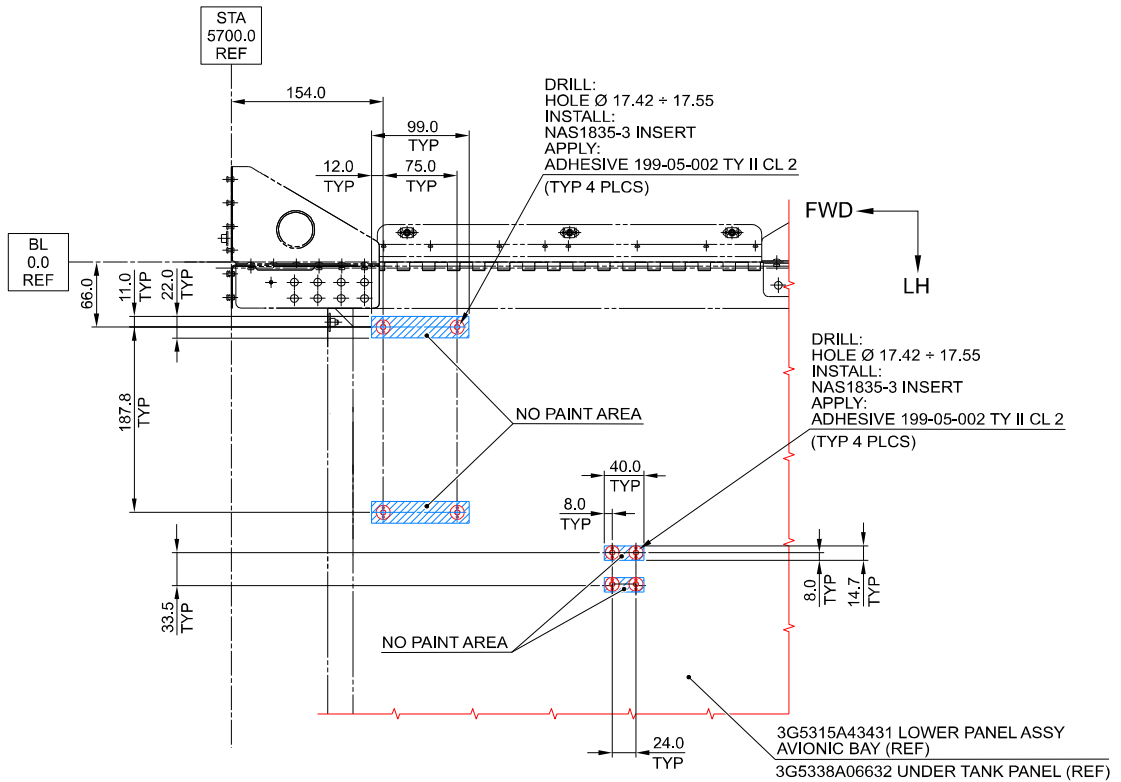
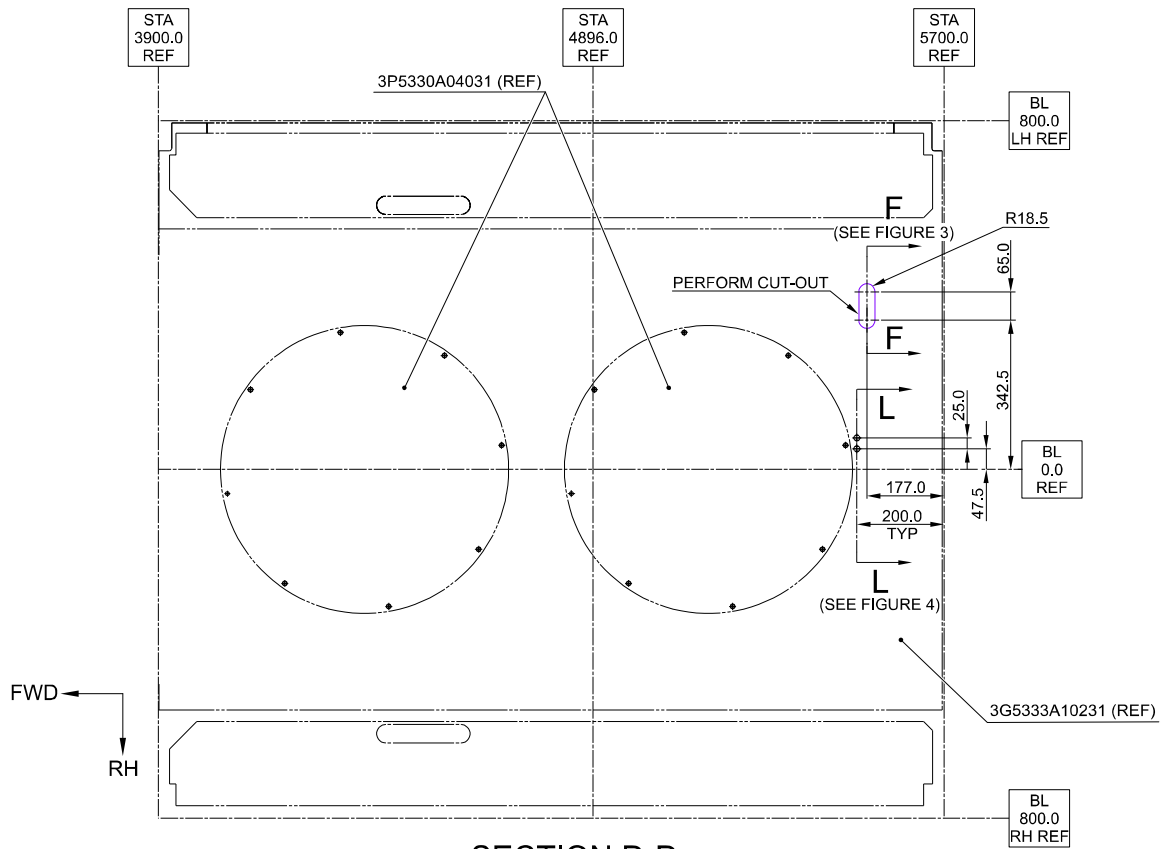

Figure 1



DETAIL C

(REFER TO FIGURE 1)



SECTION D-D

(REFER TO FIGURE 1)

Figure 2

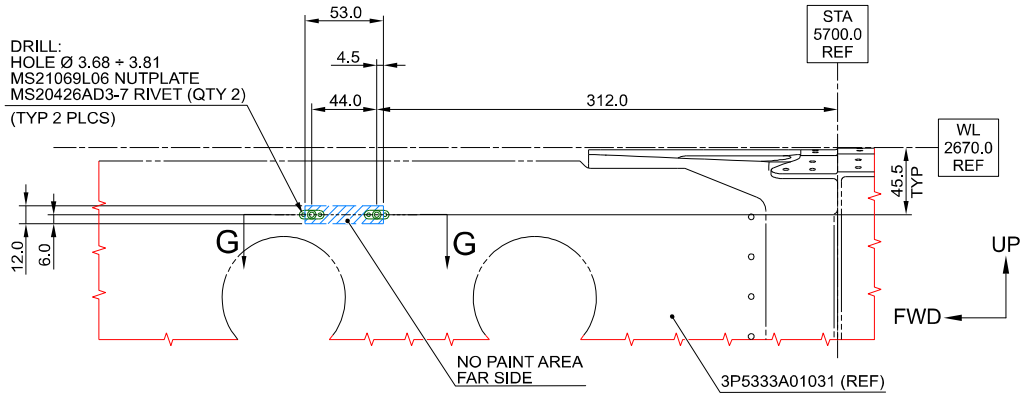

DETAIL E
(REFER TO FIGURE 1)

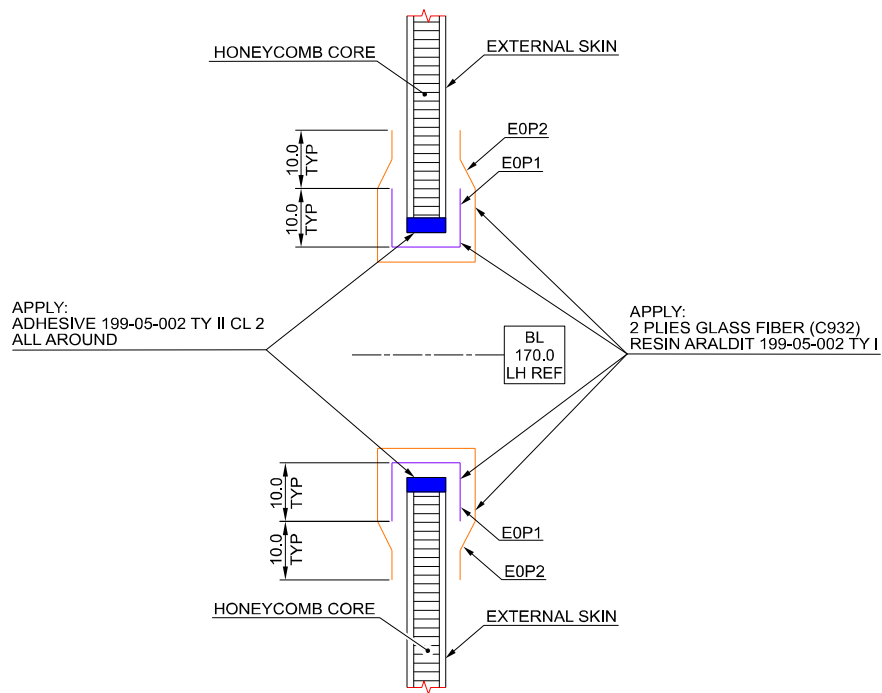

SCHEMATIC SECTION F-F
(REFER TO FIGURE 2)

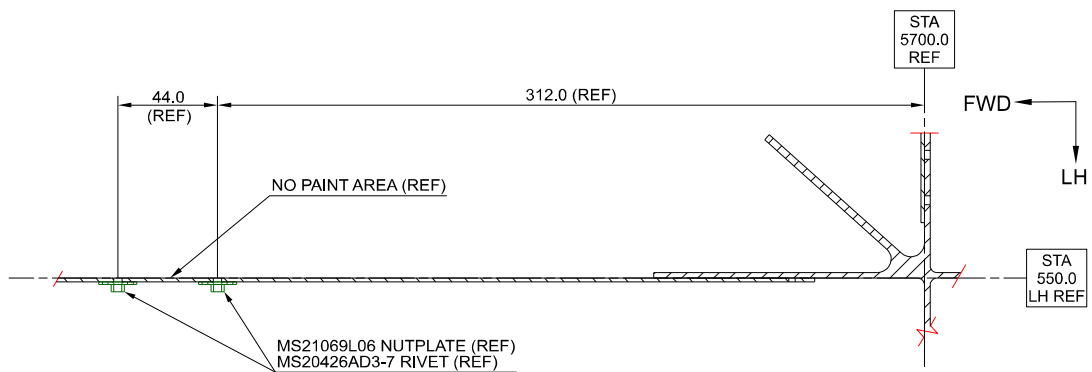

SECTION G-G

Figure 3

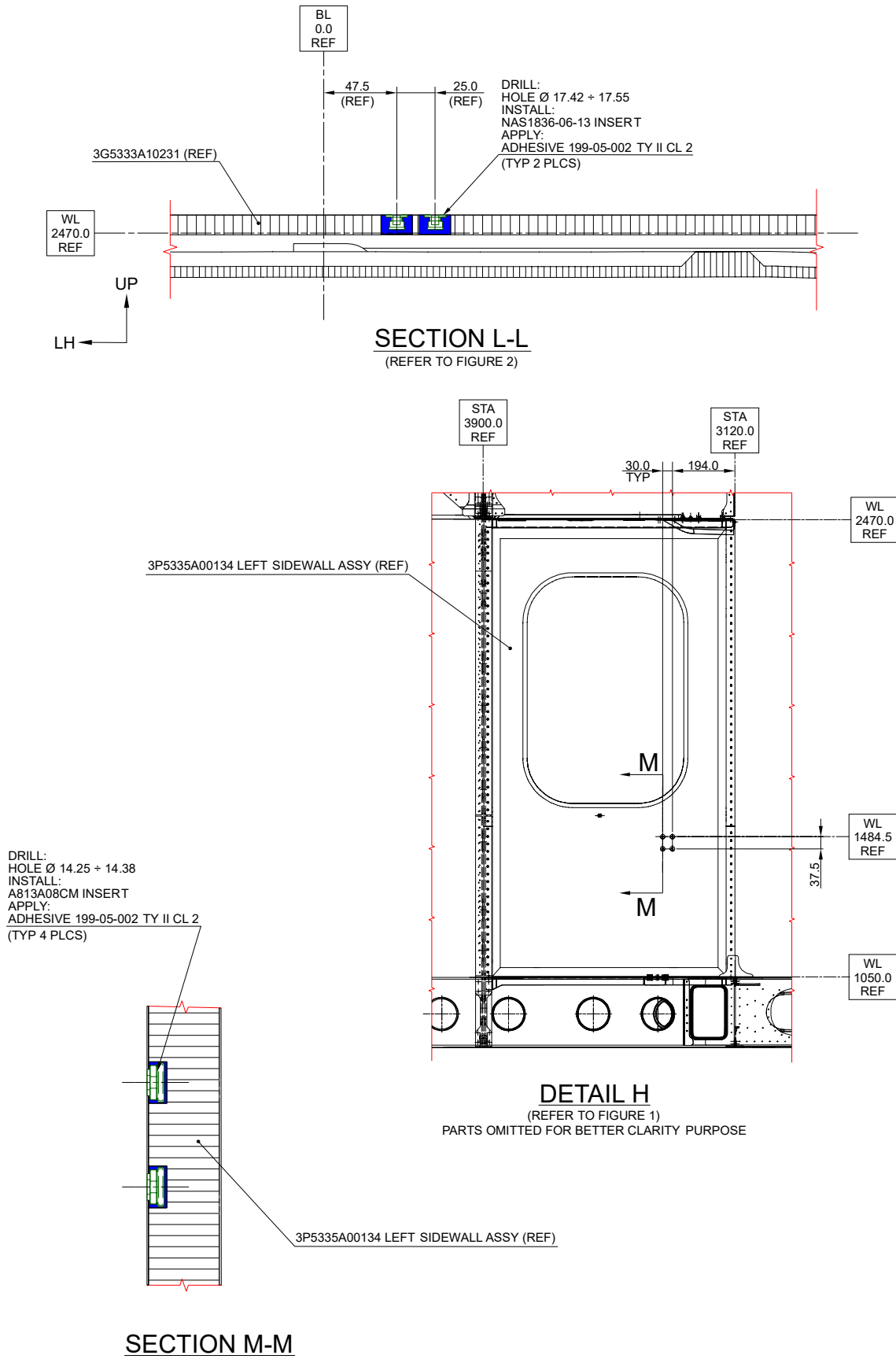

Figure 4

S.B. N°139-564
DATE: October 12, 2022
REVISION: /

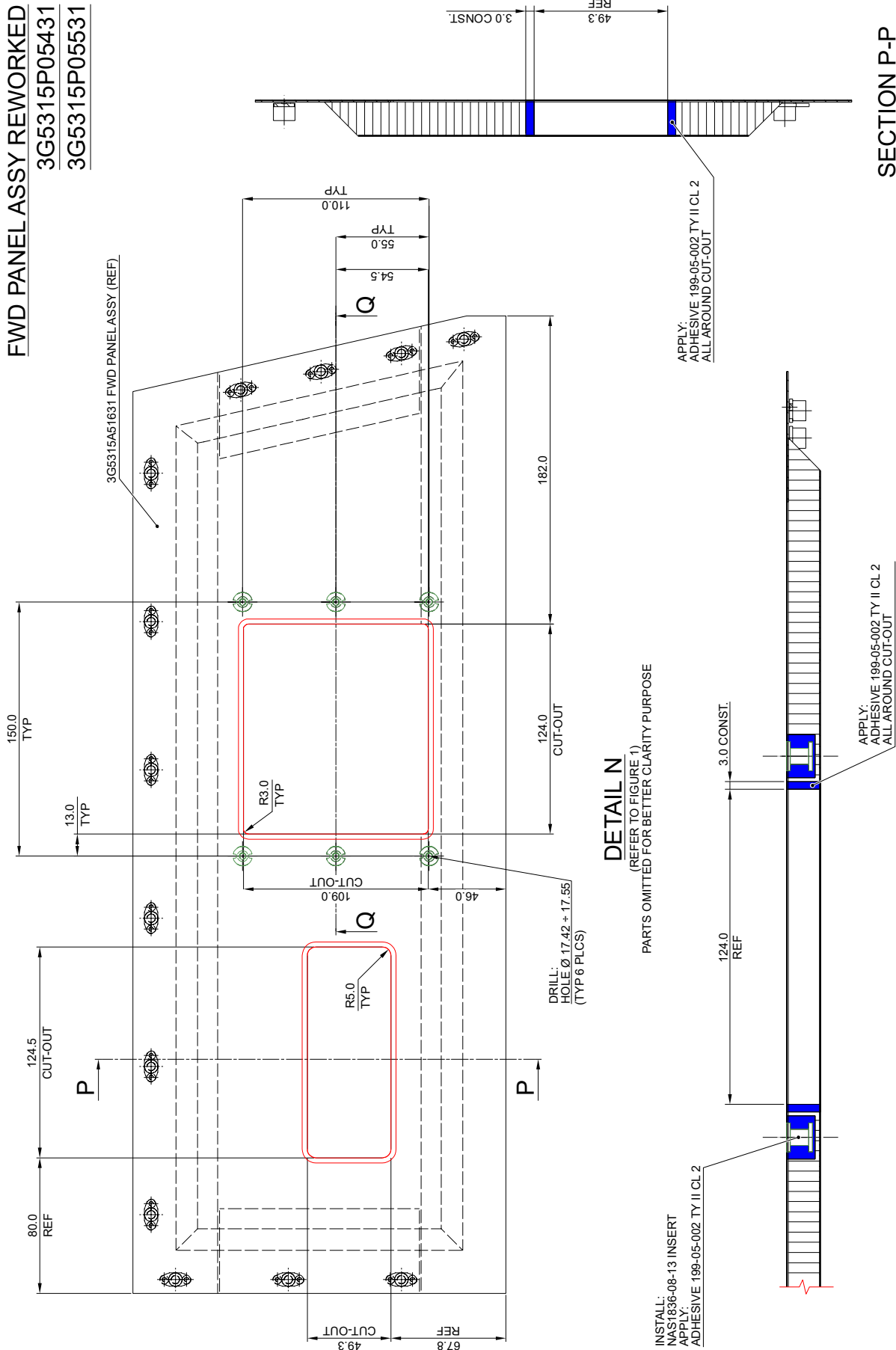

Figure 5

ICS AV900 CABIN STATION 4 ELECTRICAL PROVISION
4G2350A03412

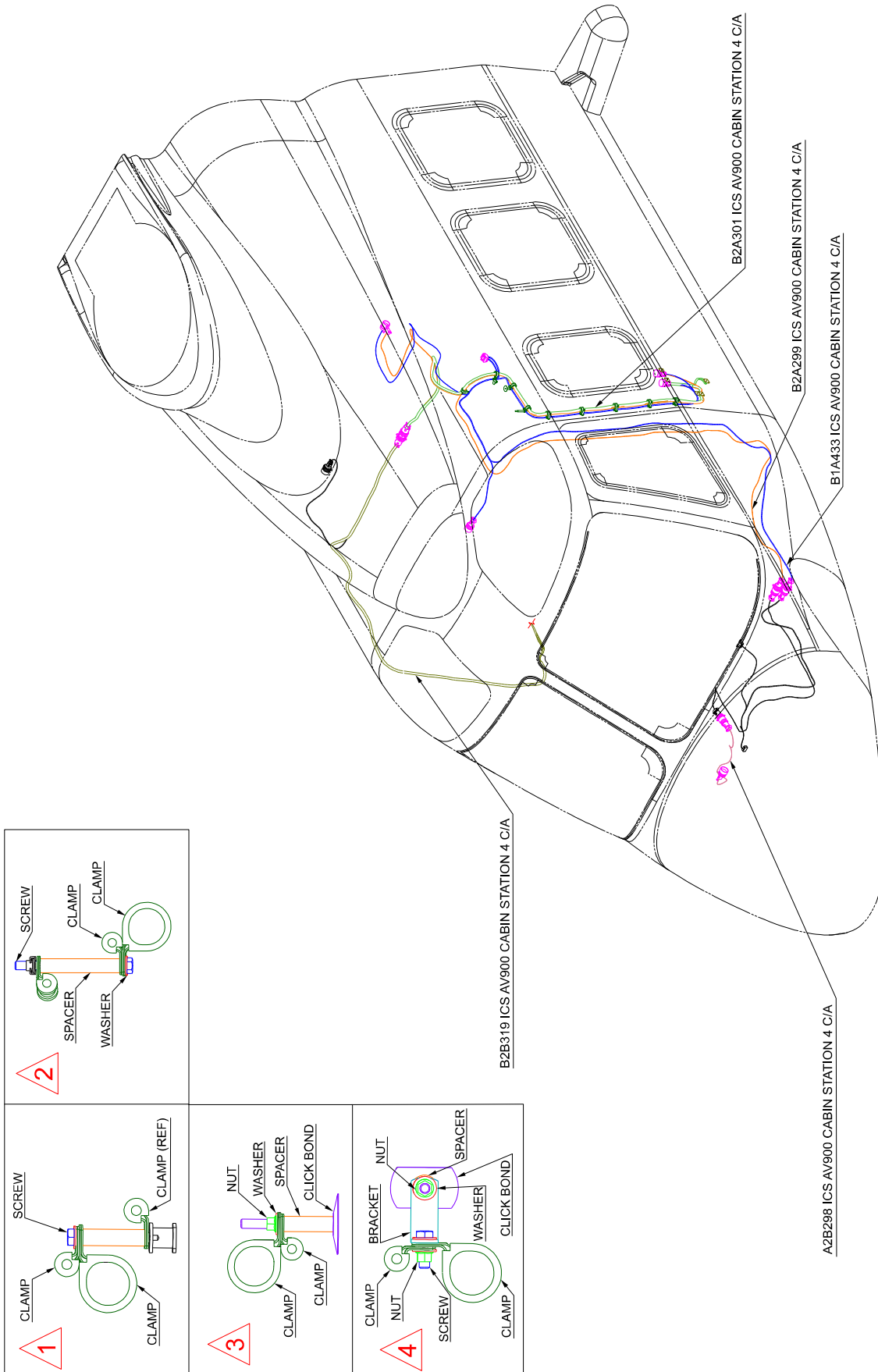
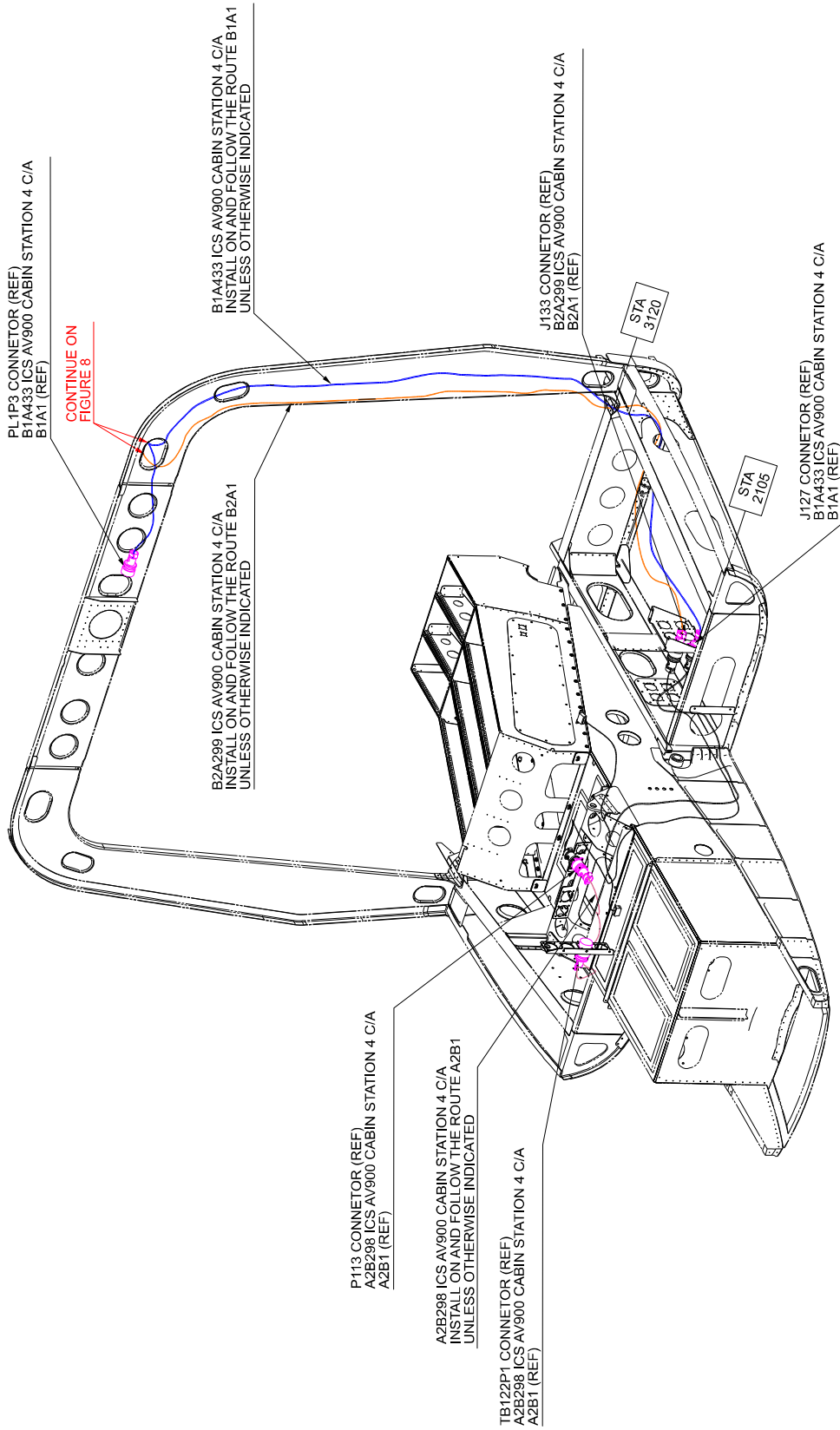

Figure 6



VIEW LOOKING COCKPIT LH SIDE FROM STA 1500 TO STA 3120

PARTS OMITTED FOR BETTER CLARITY PURPOSE

Figure 7

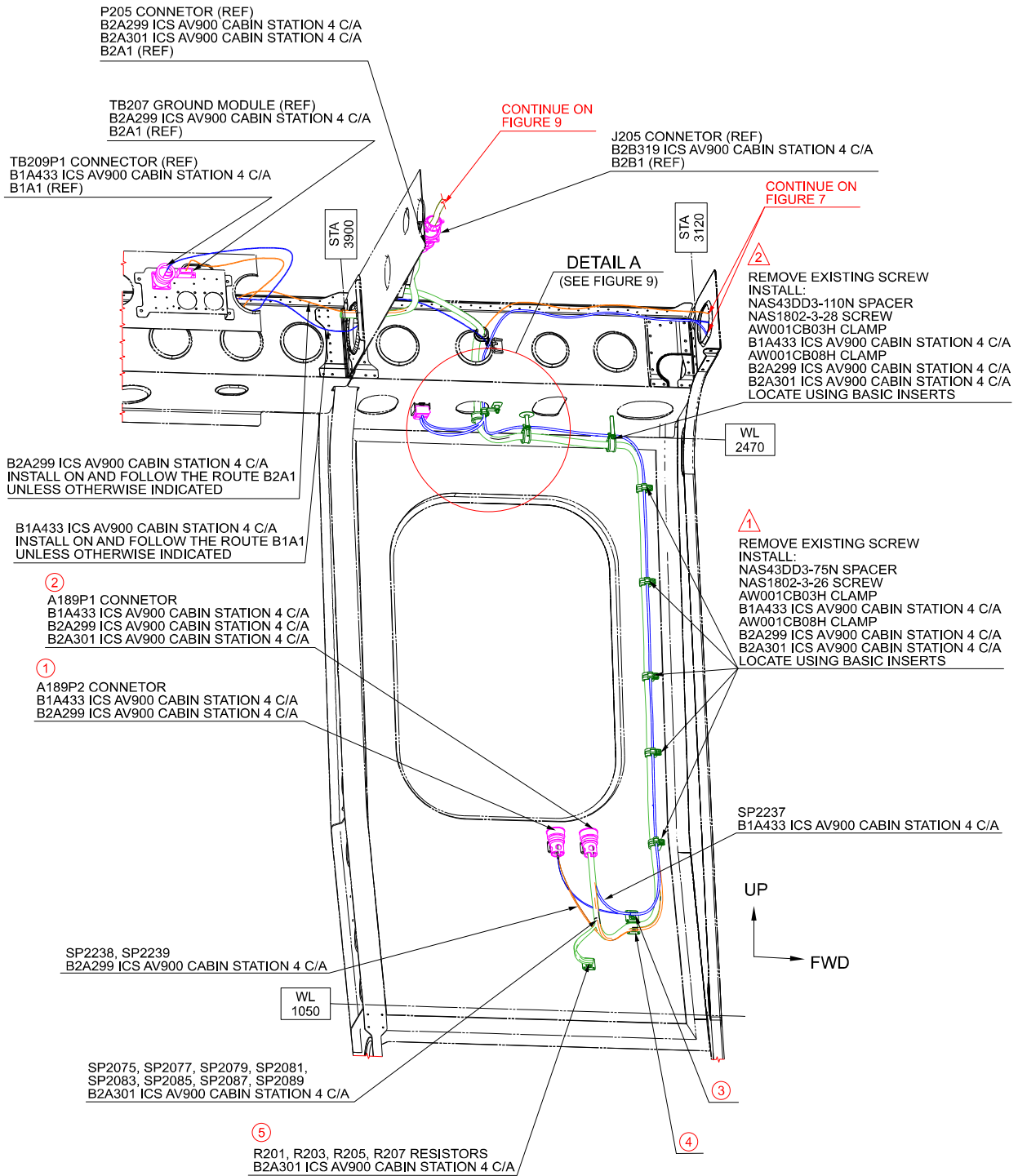

VIEW LOOKING OUTBOARD CABN LH SIDE FROM STA 3120 TO STA 3900

PARTS OMITTED FOR BETTER CLARITY PURPOSE

INSTALL ELECTRICAL SUPPORT REPORTED IN TABLE BELOW:

LOCATION NUMBER	PART. NUMBER	STA	BL	WL	ORIENTATION
①	AW001CL000A-X3	3445	-1100	1520	0°
②	AW001CL000A-X3	3370	-1100	1520	0°
③	AW001CL000A-X3	3285	-1080	1330	0°
④	AW001CL000A-X3	3285	-1080	1300	0°
⑤	AW001CL000A-X3	3370	-1080	1230	0°

Figure 8

B2B319 ICS AV900 CABIN STATION 4 C/A
INSTALL ON AND FOLLOW THE ROUTE B2B1
UNLESS OTHERWISE INDICATED

CONTINUE ON
FIGURE 8

B2B319 ICS AV900 CABIN STATION 4 C/A
INSTALL ON AND FOLLOW THE ROUTE
B2B13 ICS AV900 CABIN STATION 3 C/A
UNLESS OTHERWISE INDICATED

LH UP
FWD

SP2066, SP2068, SP2070, SP2072
B2B319 ICS AV900 CABIN STATION 4 C/A

REMOVE RESISTORS R200, R202, R204, R206
FROM B2B313 ICS CABIN STATION 3 C/A (REF)
BEFORE CONNECTING TO THE SPLICES
SP2066, SP2068, SP2070, SP2072

VIEW LOOKING OUTBOARD CABN RH SIDE FROM STA 3120 TO STA 3900

PARTS OMITTED FOR BETTER CLARITY PURPOSE

INSTALL:
A522A02A MOUNTING RAIL
A524A1A-A IDENTIFICATION PLATE
A524A2A-A IDENTIFICATION PLATE
A593A-A02 TERMINAL BOARD
A593A-B03 TERMINAL BOARD
NAS1802-08-7 SCREW (QTY 2)
NAS1149DN816J WASHER (QTY 2)
APPLY:
ED300TB277 DECAL

INSTALL:
AW001CB13H CLAMP
B2A299 ICS AV900 CABIN STATION 4 C/A
B2A301 ICS AV900 CABIN STATION 4 C/A
(MOUNT ON EXISTING HARDWARE)

INSTALL:
NAS43DD3-16N SPACER
NAS1802-3-14 SCREW
NAS1149D0332J WASHER
B1A433 ICS AV900 CABIN STATION 4 C/A
(MOUNT ON EXISTING HARDWARE)

④ ①

INSTALL:
AW001CB03H CLAMP
B1A433 ICS AV900 CABIN STATION 4 C/A
AW001CB13H CLAMP
B2A299 ICS AV900 CABIN STATION 4 C/A
B2A301 ICS AV900 CABIN STATION 4 C/A
MS9592-014 BRACKET
NAS1802-3-9 SCREW
NAS43DD3-20N SPACER
MS21042L3 NUT (QTY 2)
NAS1149D0332J WASHER (QTY 3)

③ ②

INSTALL:
AW001CB03H CLAMP
B1A433 ICS AV900 CABIN STATION 4 C/A
AW001CB13H CLAMP
B2A299 ICS AV900 CABIN STATION 4 C/A
B2A301 ICS AV900 CABIN STATION 4 C/A
NAS43DD3-65N SPACER
MS21042L3 NUT
NAS1149D0332J WASHER

INSTALL ELECTRICAL SUPPORT REPORTED IN TABLE BELOW:

LOCATION NUMBER	PART. NUMBER	STA	BL	WL	ORIENTATION
①	A366A3E12C75	3545	-900	2470	0°
②	A366A3E32C	3370	-945	2470	0°

DETAIL A

PARTS OMITTED FOR BETTER CLARITY PURPOSE
(REFER TO FIGURE 8)

Figure 9

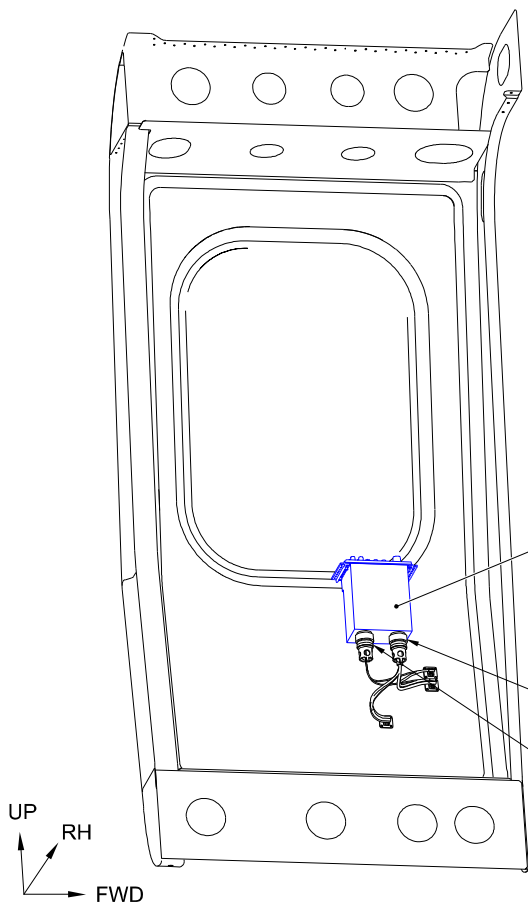
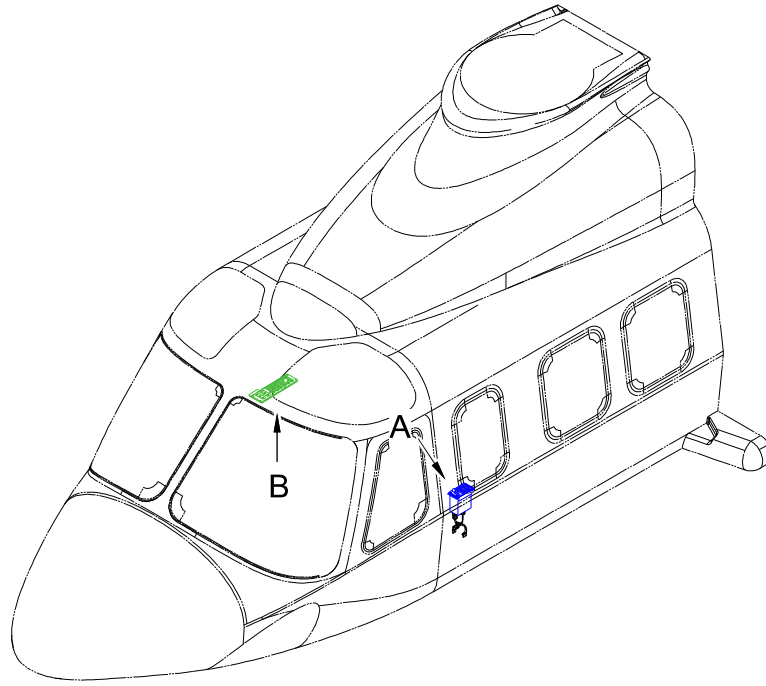

VIEW A

PARTS OMITTED FOR BETTER CLARITY PURPOSE

INSTALL:
7511900-99002 AV 900 AUDIO PANEL OR
7511900-99202 AV 900 AUDIO PANEL
APPLY:
ED300A189 DECAL

A189P1 CONNETOR
B1A433 ICS AV900 CABIN STATION 4 C/A (REF)
B2A299 ICS AV900 CABIN STATION 4 C/A (REF)
B2A301 ICS AV900 CABIN STATION 4 C/A (REF)

A189P2 CONNETOR
B1A433 ICS AV900 CABIN STATION 4 C/A (REF)
B2A299 ICS AV900 CABIN STATION 4 C/A (REF)

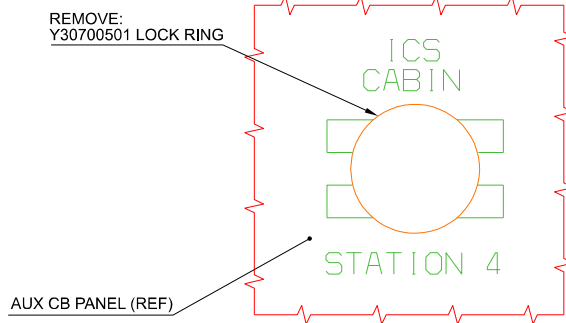

VIEW B

PARTS OMITTED FOR BETTER CLARITY PURPOSE

Figure 10

12VDC 5AMP MAX UTILITY SCKTS STRUC PROV
3G5311A41011

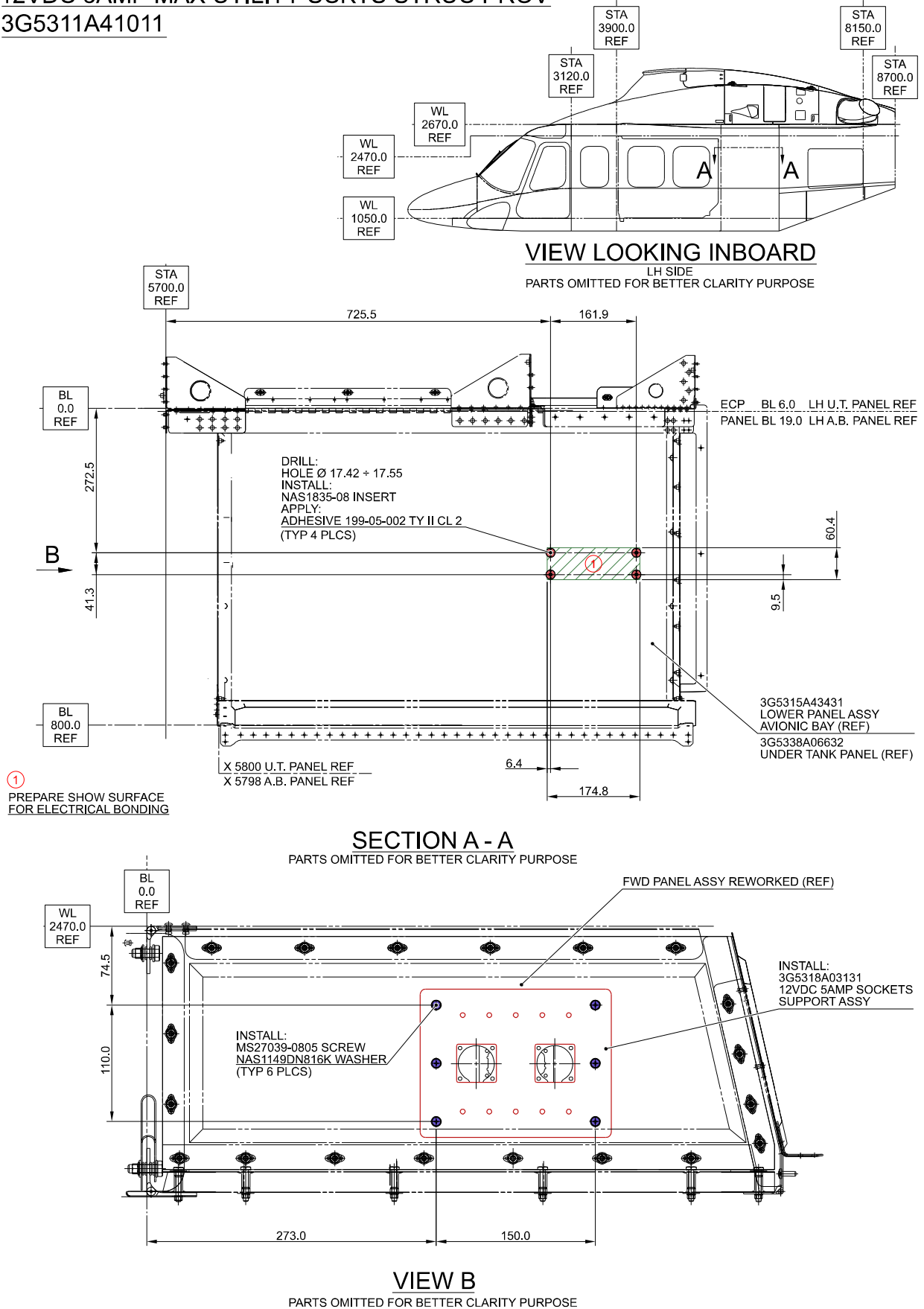
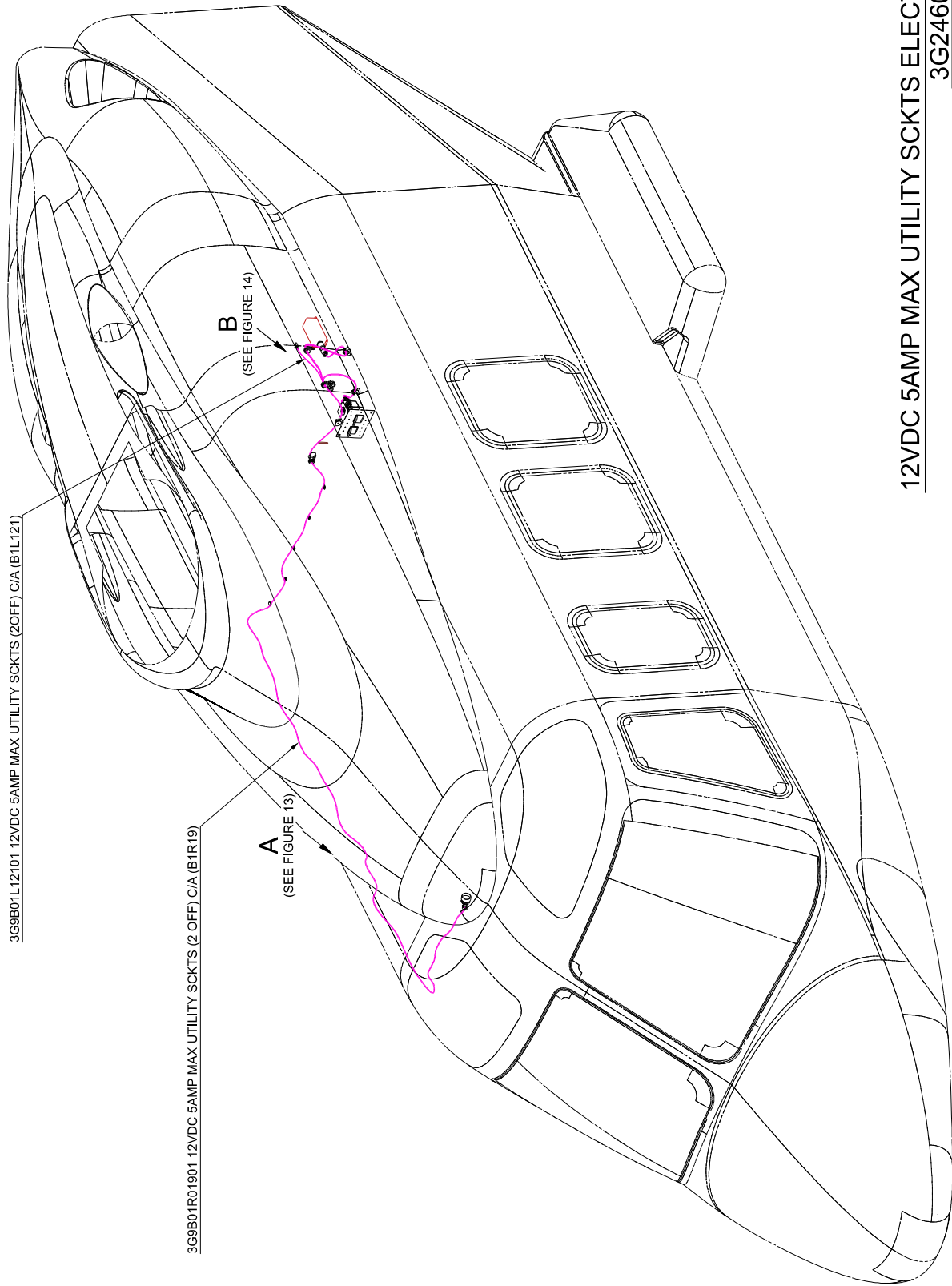

Figure 11



12VDC 5AMP MAX UTILITY SOCKTS ELECT INSTL
3G2460A04811

Figure 12

S.B. N°139-564
DATE: October 12, 2022
REVISION: /

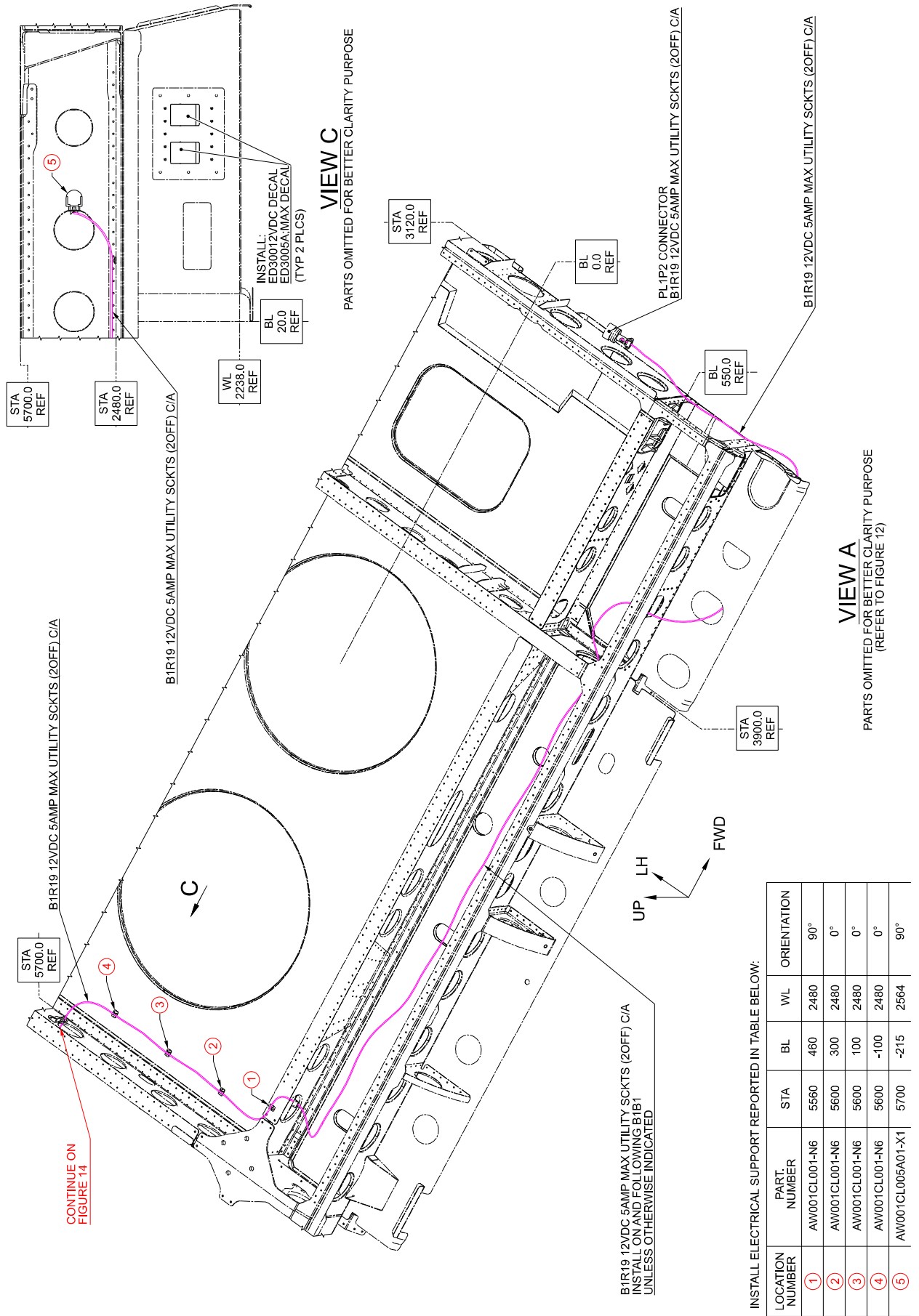

Figure 13

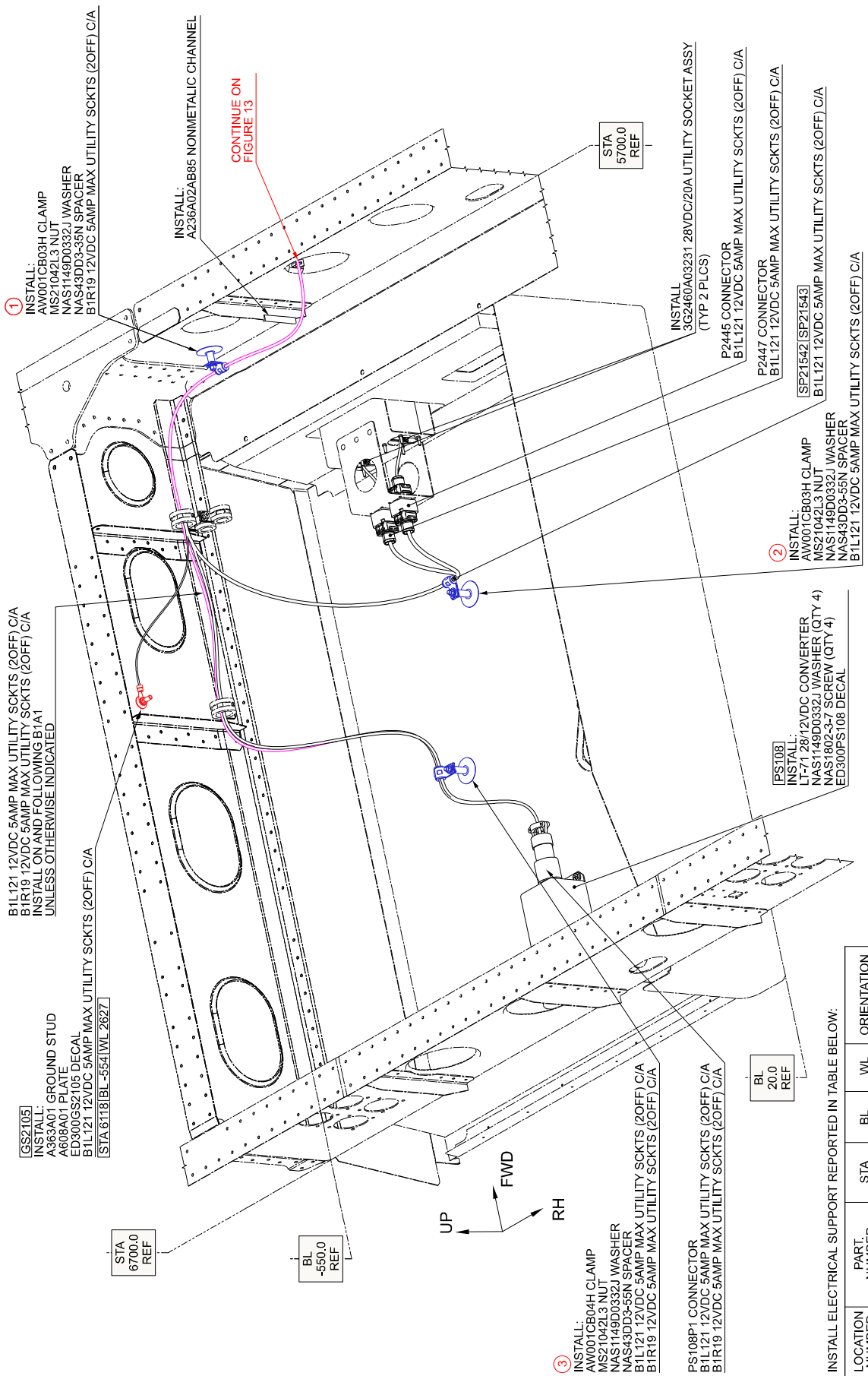

Figure 14

INSTALL ELECTRICAL SUPPORT REPORTED IN TABLE BELOW:

LOCATION NUMBER	PART. NUMBER	STA	BL	WL	ORIENTATION
①	A366A3E16C	5700	-430	2510	-
②	A366A3E22C	6026	-355	2238	-
③	A366A3E22C	6230	-423	2238	-

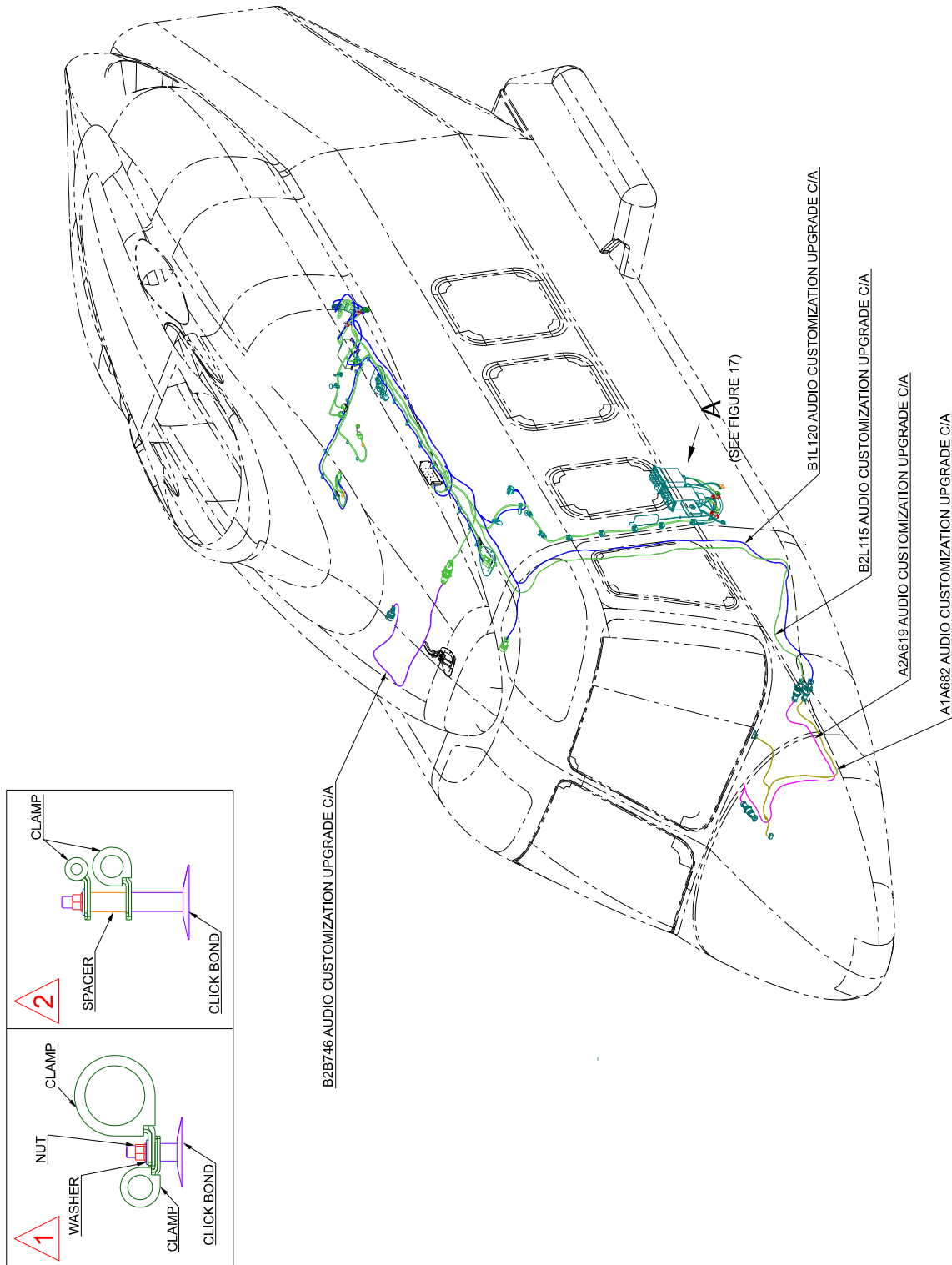

Figure 15

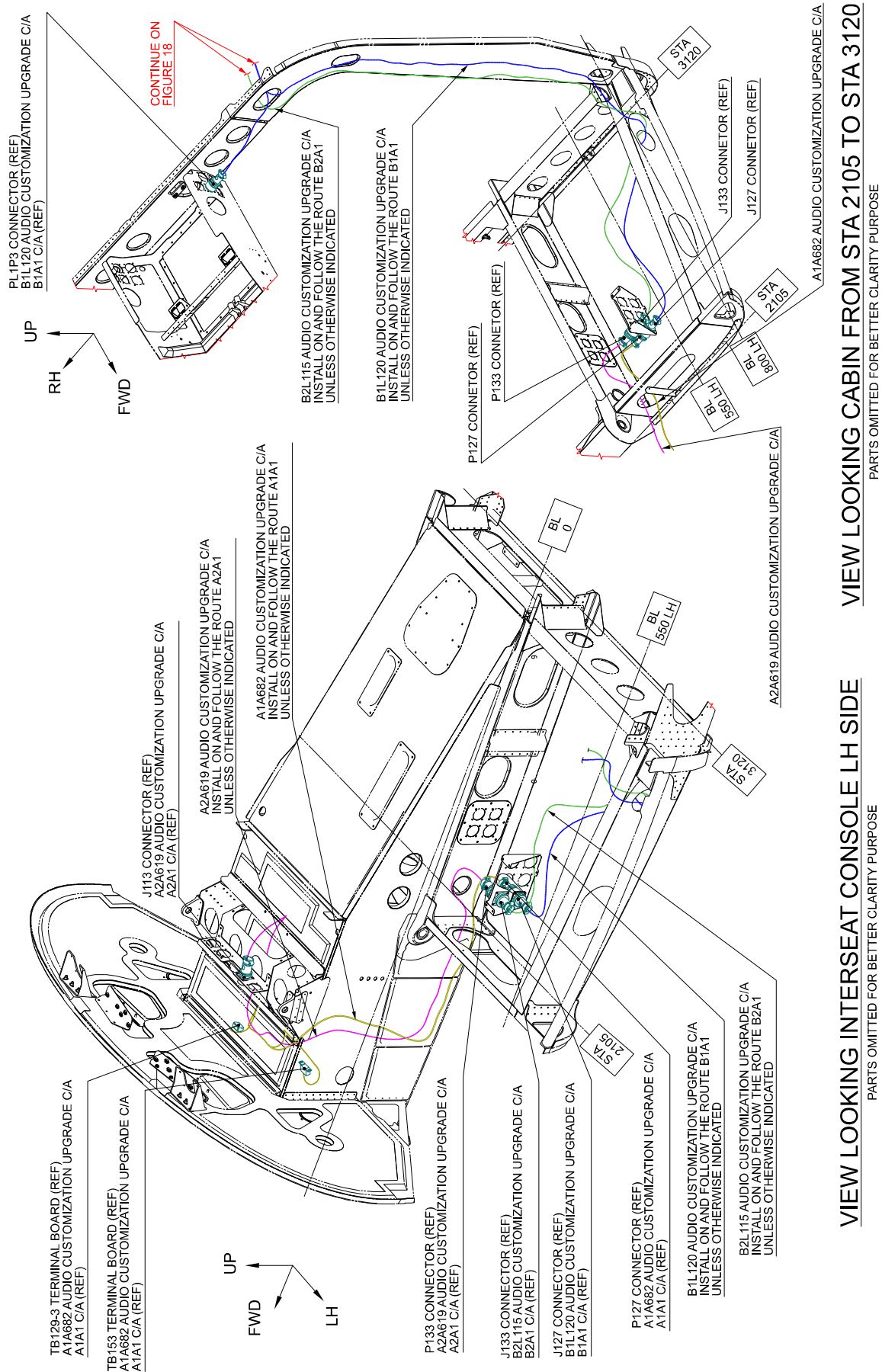

Figure 16

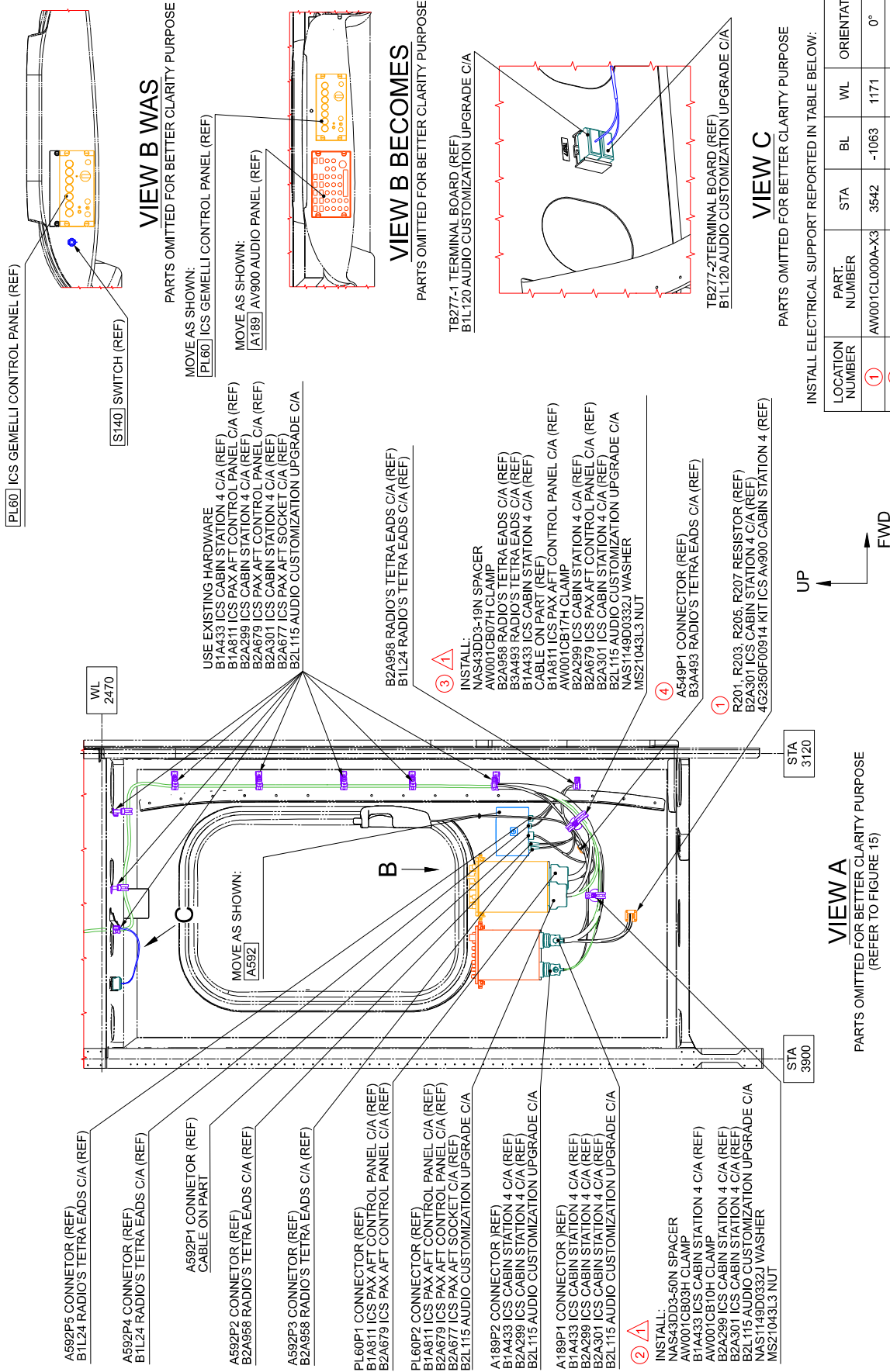
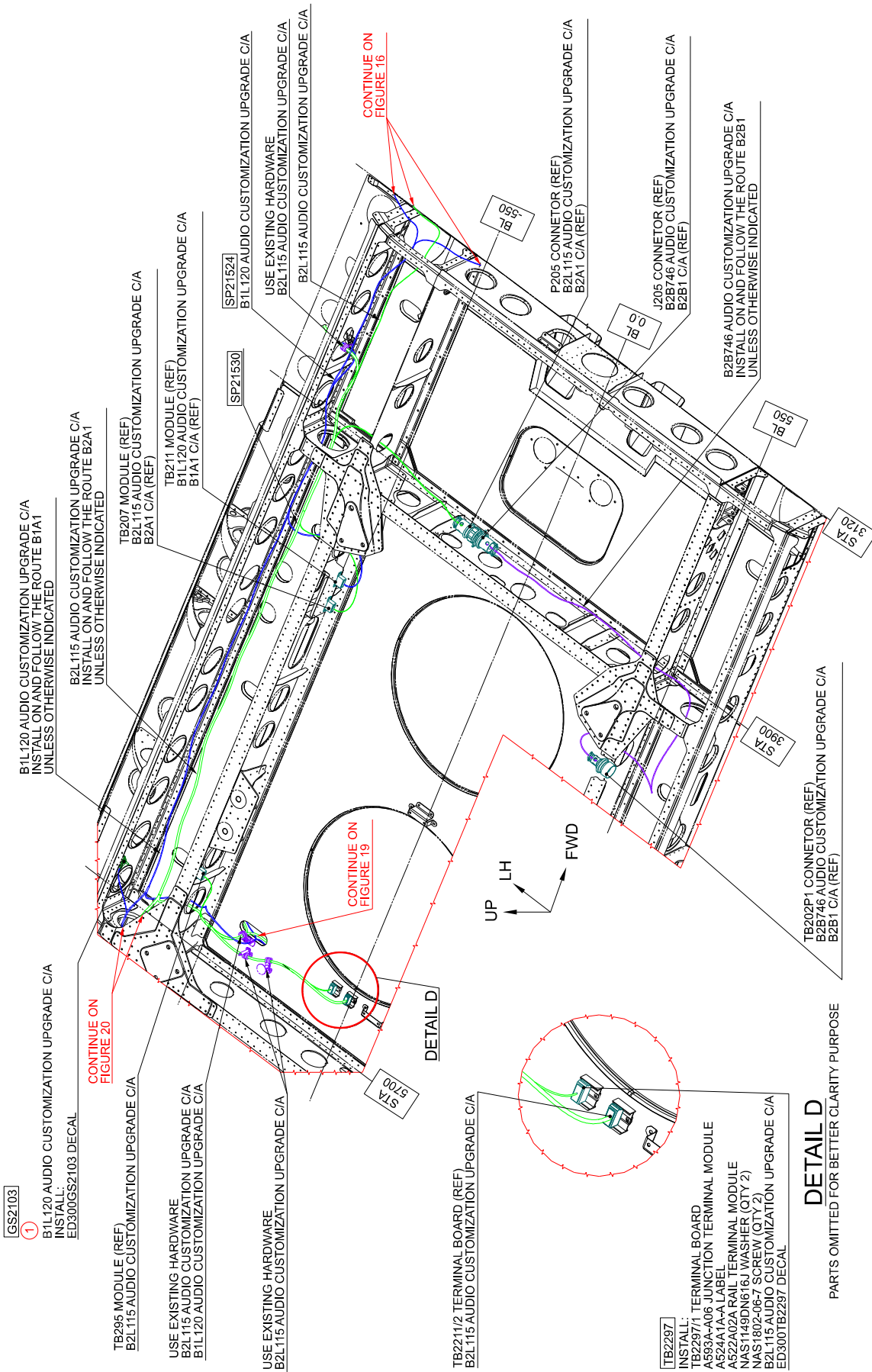

Figure 17

S.B. N°139-564
DATE: October 12, 2022
REVISION: /

INSTALL ELECTRICAL SUPPORT REPORTED IN TABLE BELOW:

LOCATION NUMBER	PART NUMBER	STA	BL	WL	ORIENTATION
①	AW001CL000A-X3	3542	-1063	1171	0°
②	A366A3E22C	3490	-1066	1262	0°
③	A366A3E16C	3309	-1071	1309	0°
④	AW001CL001-N6	3373	-1077	1296	45°



INSTALL ELECTRICAL SUPPORT REPORTED IN TABLE BELOW:

LOCATION NUMBER	PART NUMBER	STA	BL	WL	ORIENTATION
①	A363A01A	5512	-800	2597	0°

VIEW LOOKING DOWN ROOF FROM STA 3120 TO STA 5700
RH SIDE

PARTS OMITTED FOR BETTER CLARITY PURPOSE

DETAIL D

PARTS OMITTED FOR BETTER CLARITY PURPOSE

Figure 18

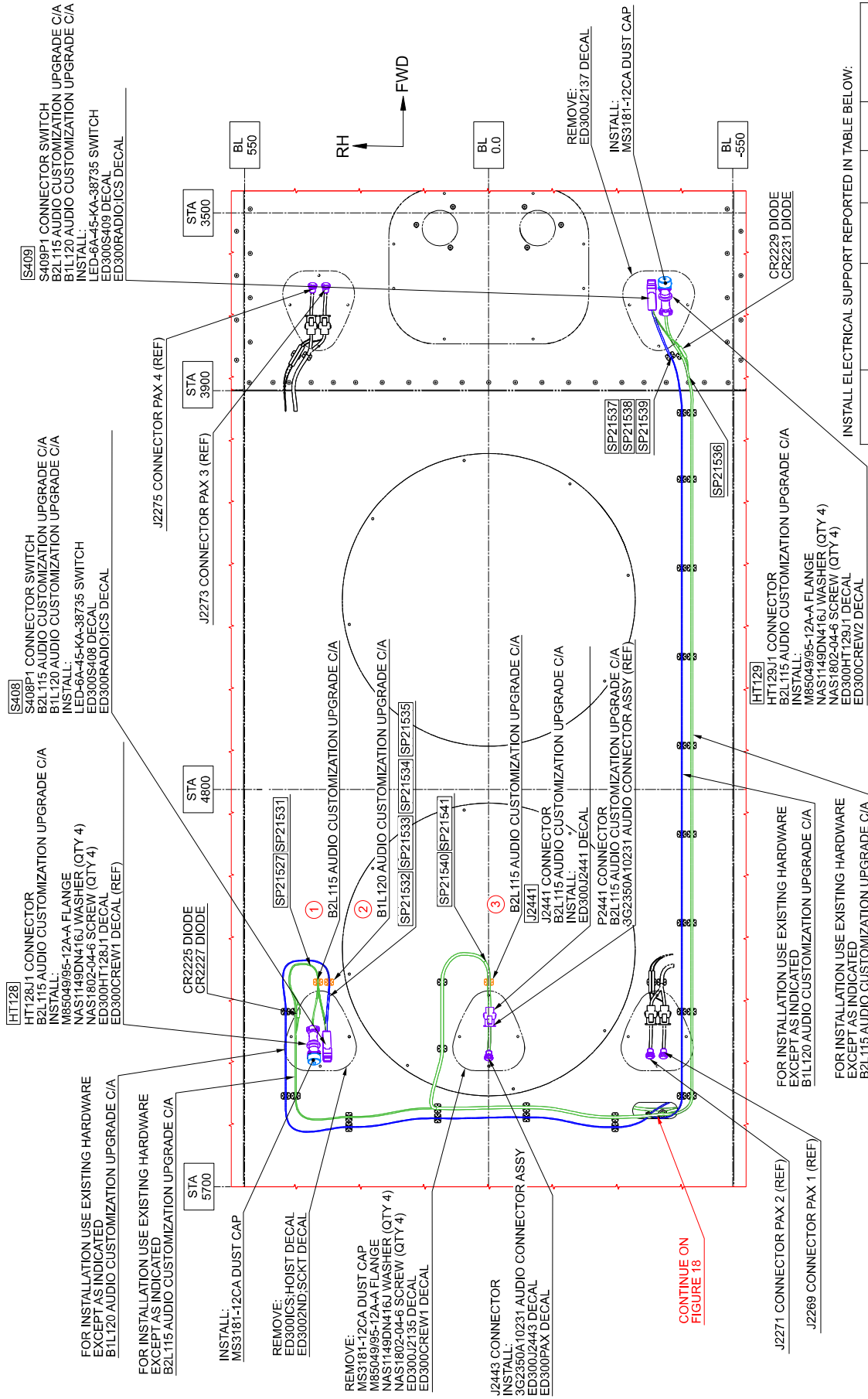

INSTALL ELECTRICAL SUPPORT REPORTED IN TABLE BELOW:

LOCATION NUMBER	PART NUMBER	STA	BL	WL	ORIENTATION
①	AW001CL001-N6	5233	385	2467	90°
②	AW001CL001-N6	5233	360	2467	90°
③	AW001CL001-N6	5233	0	2467	90°

VIEW LOOKING UP CABIN ROOF UPPER PANEL

PARTS OMITTED FOR BETTER CLARITY PURPOSE

Figure 19

S.B. N°139-564
 DATE: October 12, 2022
 REVISION: /

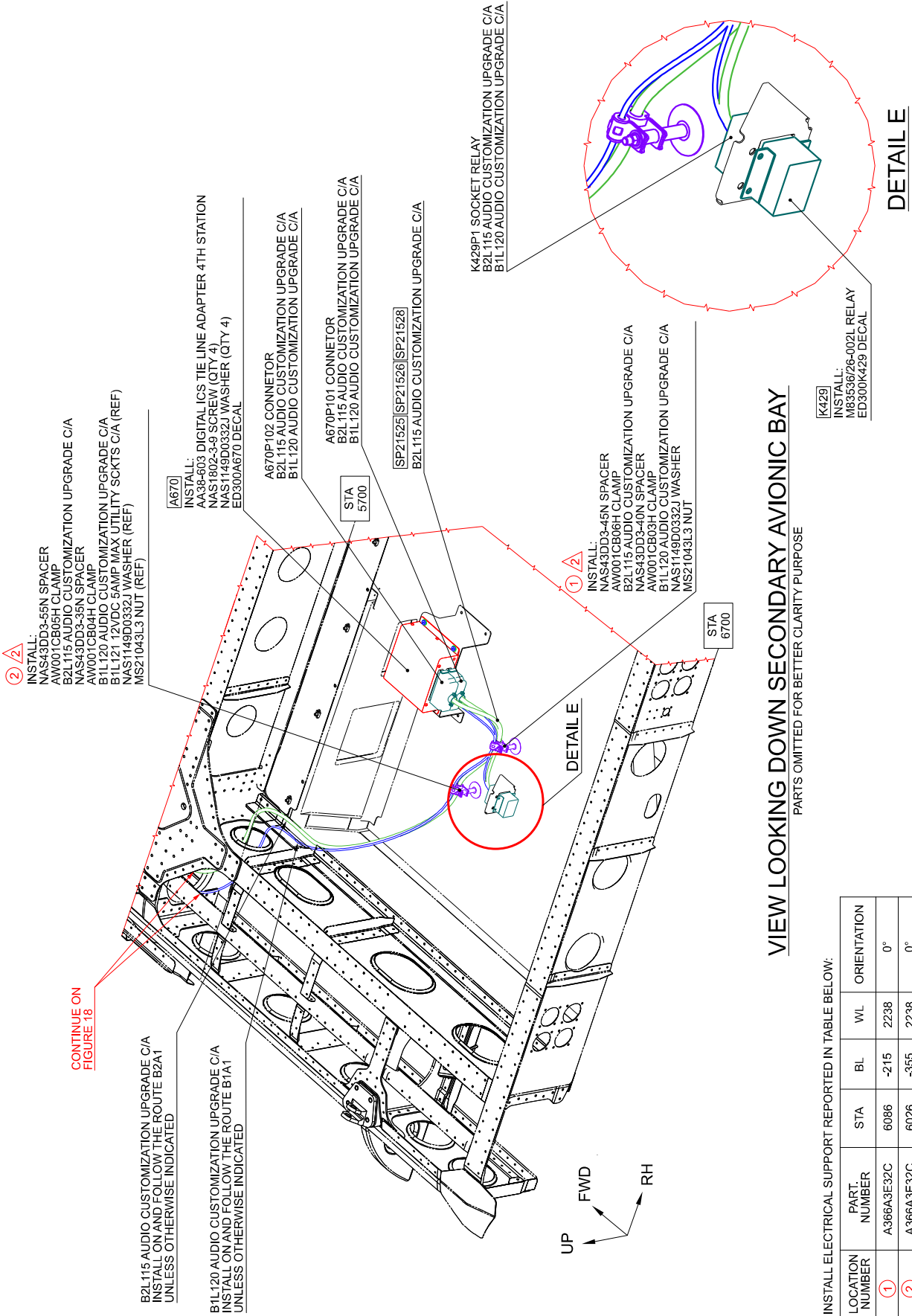
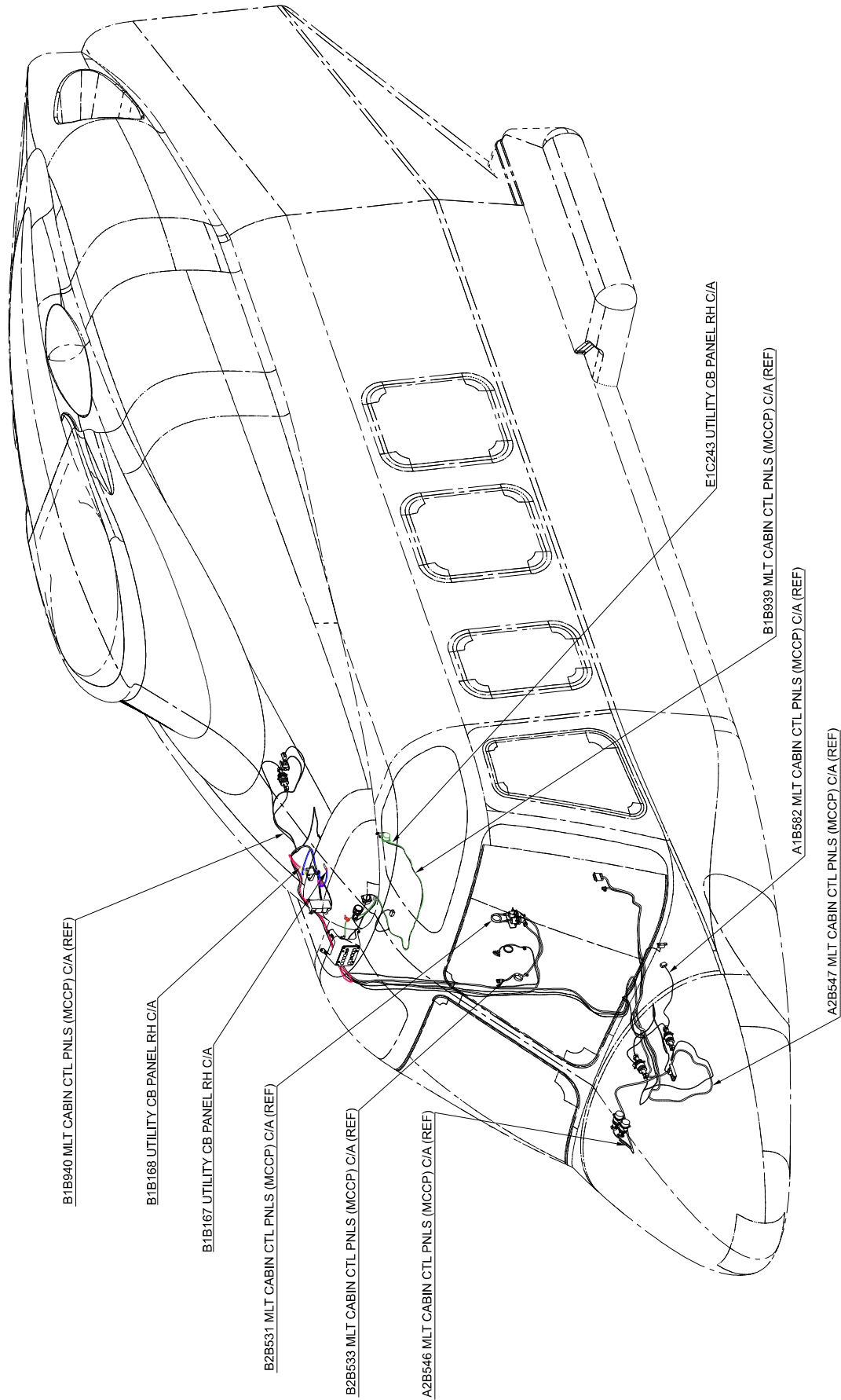
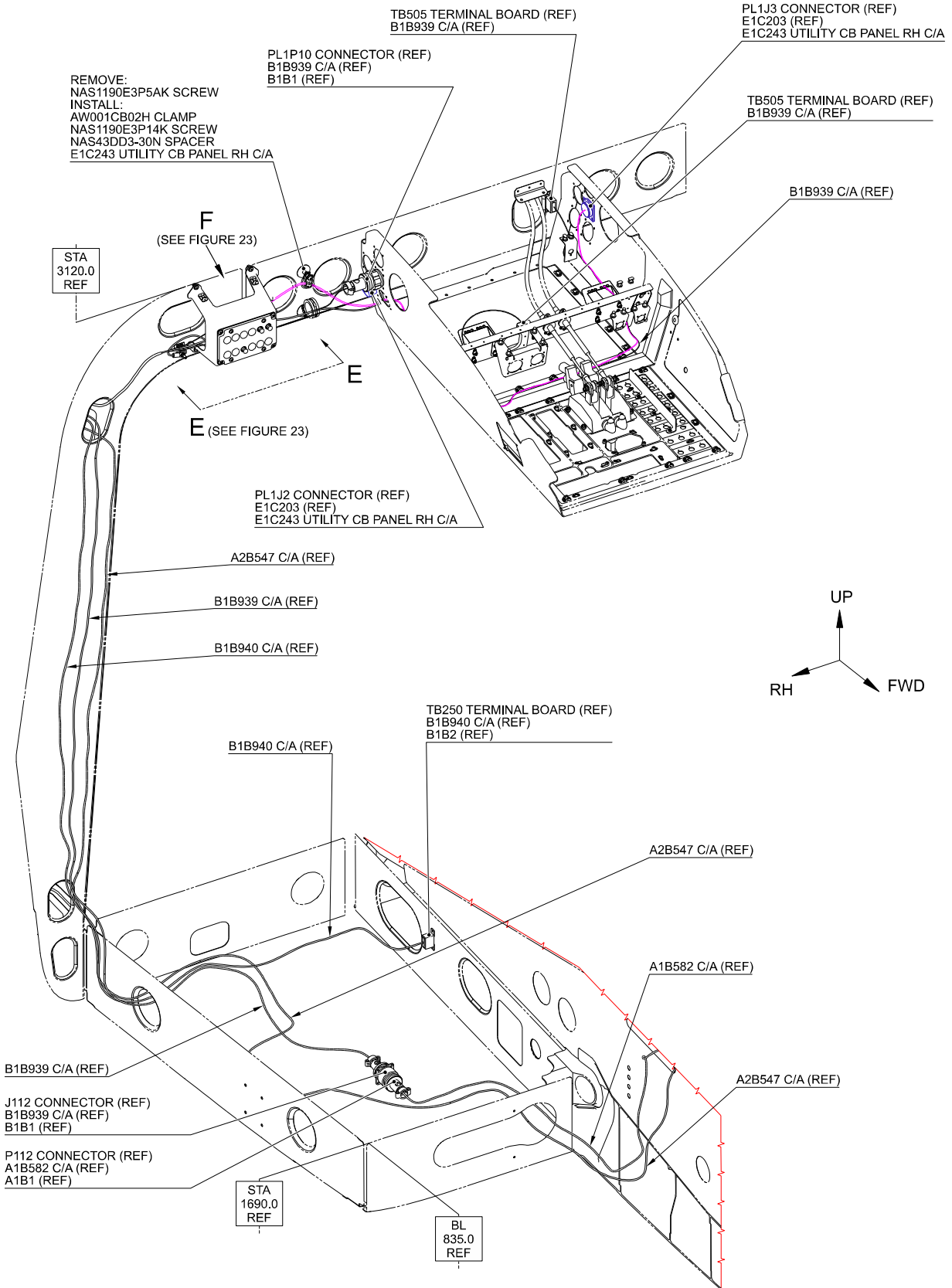

Figure 20



MLT CABIN CTL PNLS (MCCP) ELECT PROV
3G4620A00611

Figure 21



VIEW LOOKING FLOOR AREA FROM STA 1690 TO STA 3120

RH SIDE
PARTS OMITTED FOR BETTER CLARITY PURPOSE

Figure 22

S.B. N°139-564
DATE: October 12, 2022
REVISION: /

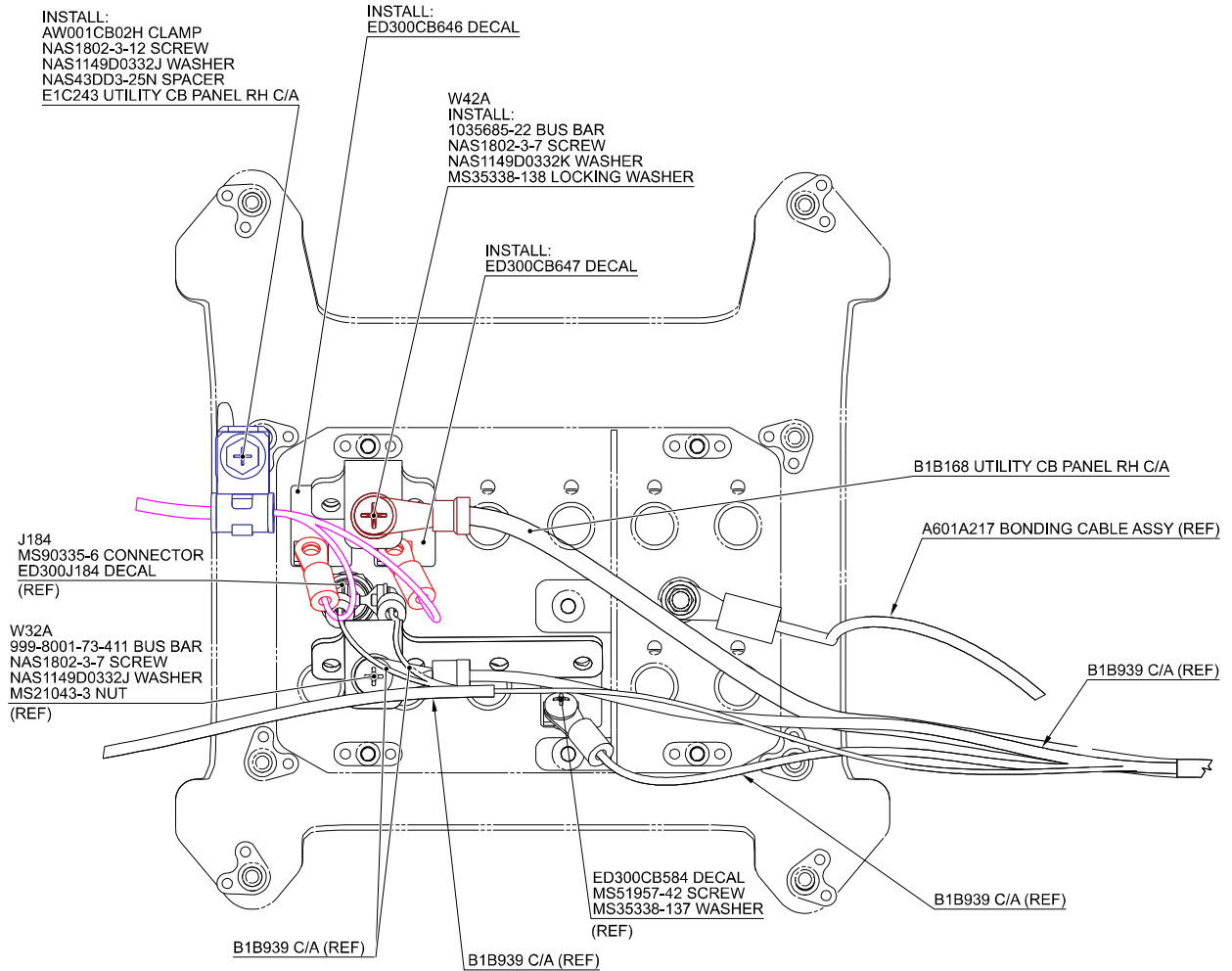

DETAIL F

PARTS OMITTED FOR BETTER CLARITY PURPOSE
(REFER TO FIGURE 22)

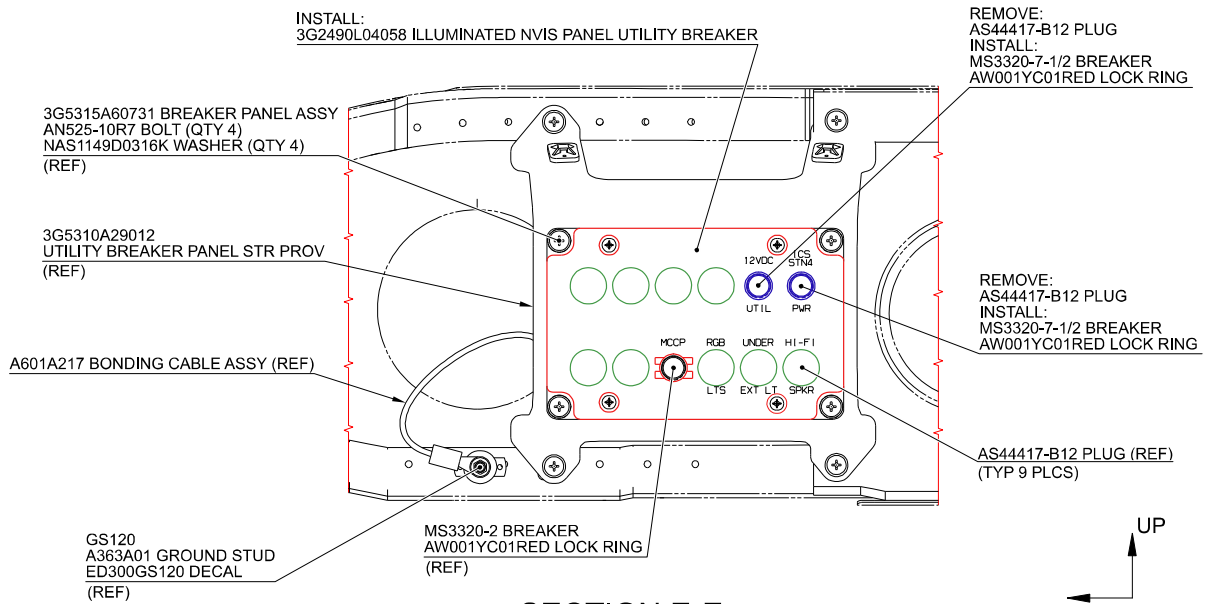

SECTION E-E

PARTS OMITTED FOR BETTER CLARITY PURPOSE
(REFER TO FIGURE 22)

Figure 23

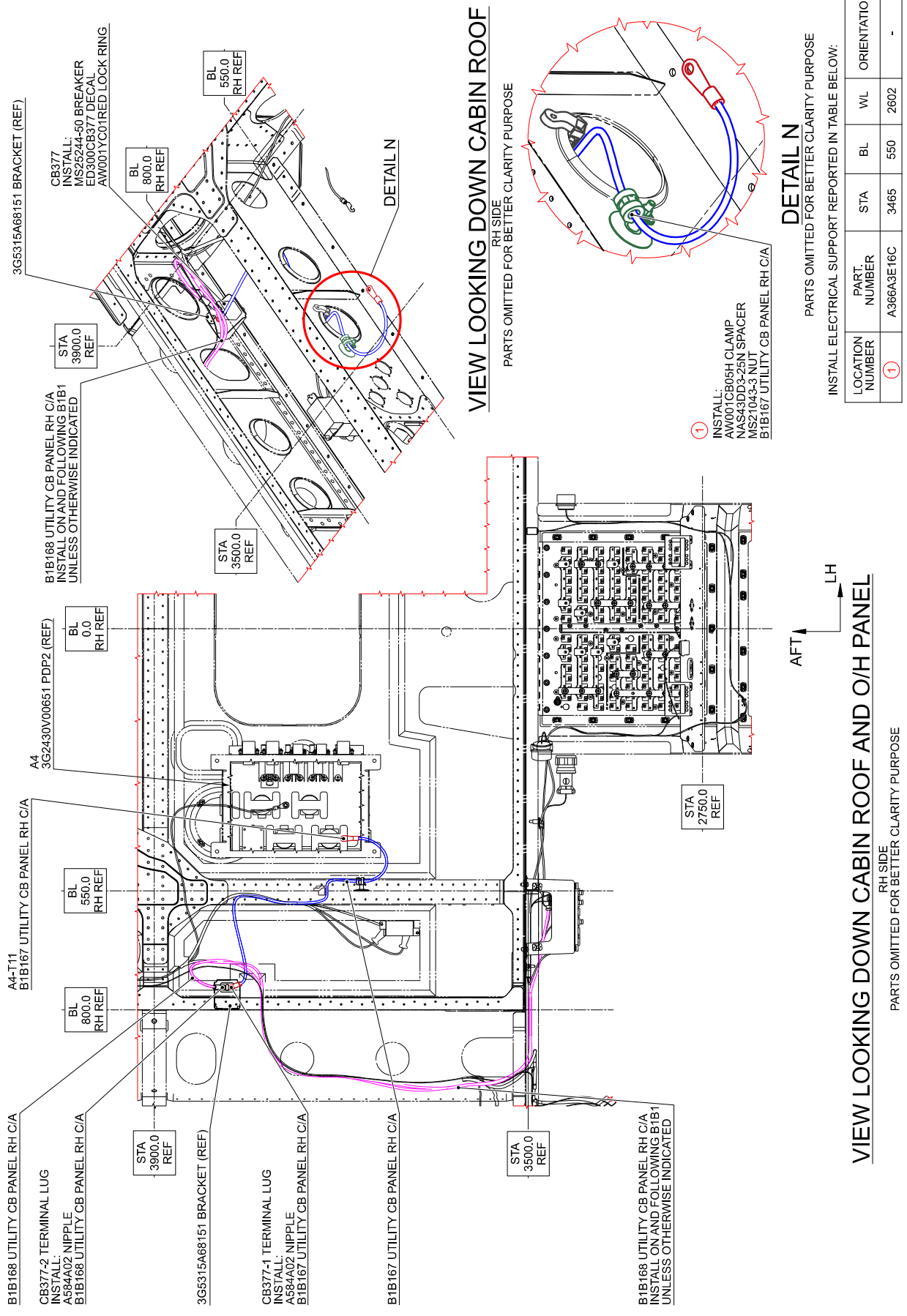
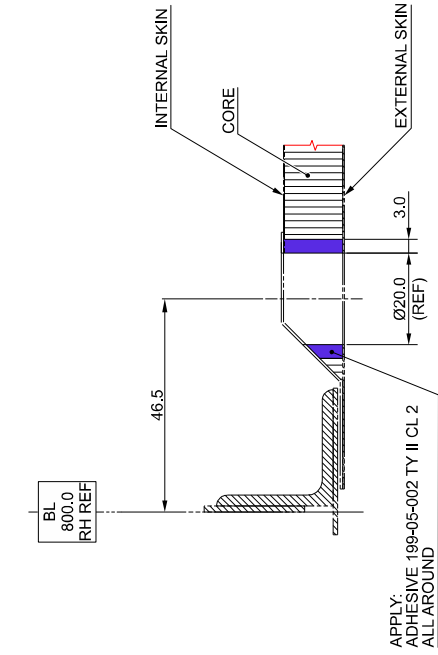
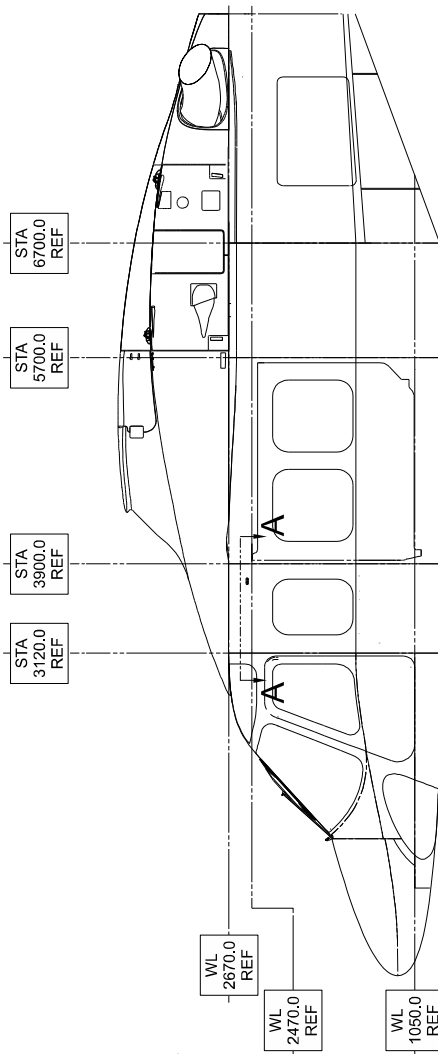

Figure 24



SECTION C-C SCHEMATIC
PARTS OMITTED FOR BETTER CLARITY PURPOSE



VIEW LOOKING INBOARD
LH SIDE
PARTS OMITTED FOR BETTER CLARITY PURPOSE

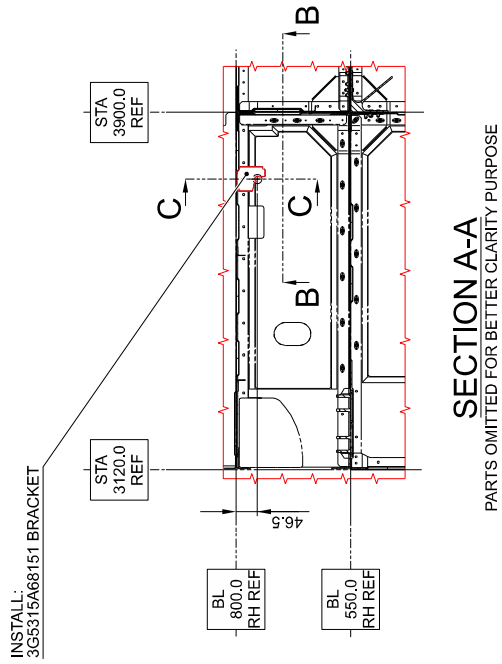

SECTION A-A
PARTS OMITTED FOR BETTER CLARITY PURPOSE

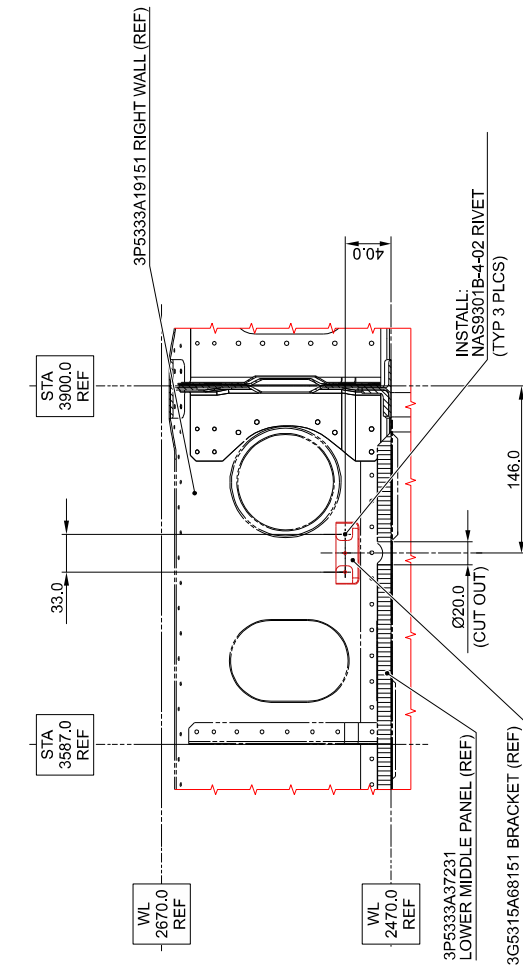

SECTION B-B
PARTS OMITTED FOR BETTER CLARITY PURPOSE

MISSION BUS RH STRUCTURAL PROVISION
3G5310A63413

Figure 25

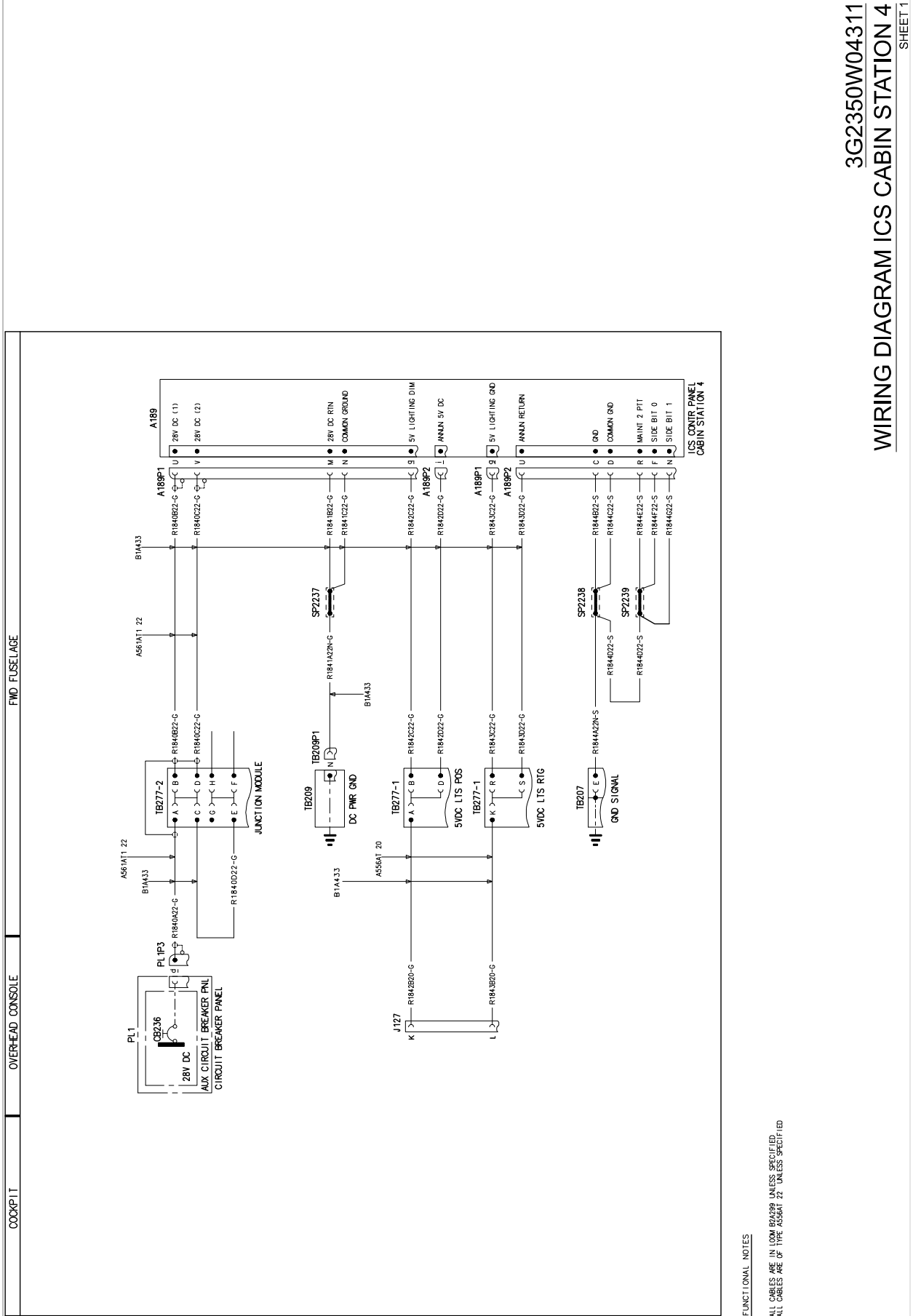

3G2350W04311
WIRING DIAGRAM ICS CABIN STATION 4
SHEET 1

FUNCTIONAL NOTES
ALL CABLES ARE IN LOW BREAKER UNLESS SPECIFIED.
ALL CABLES ARE OF TYPE ASS6AT 22 UNLESS SPECIFIED.

Figure 26

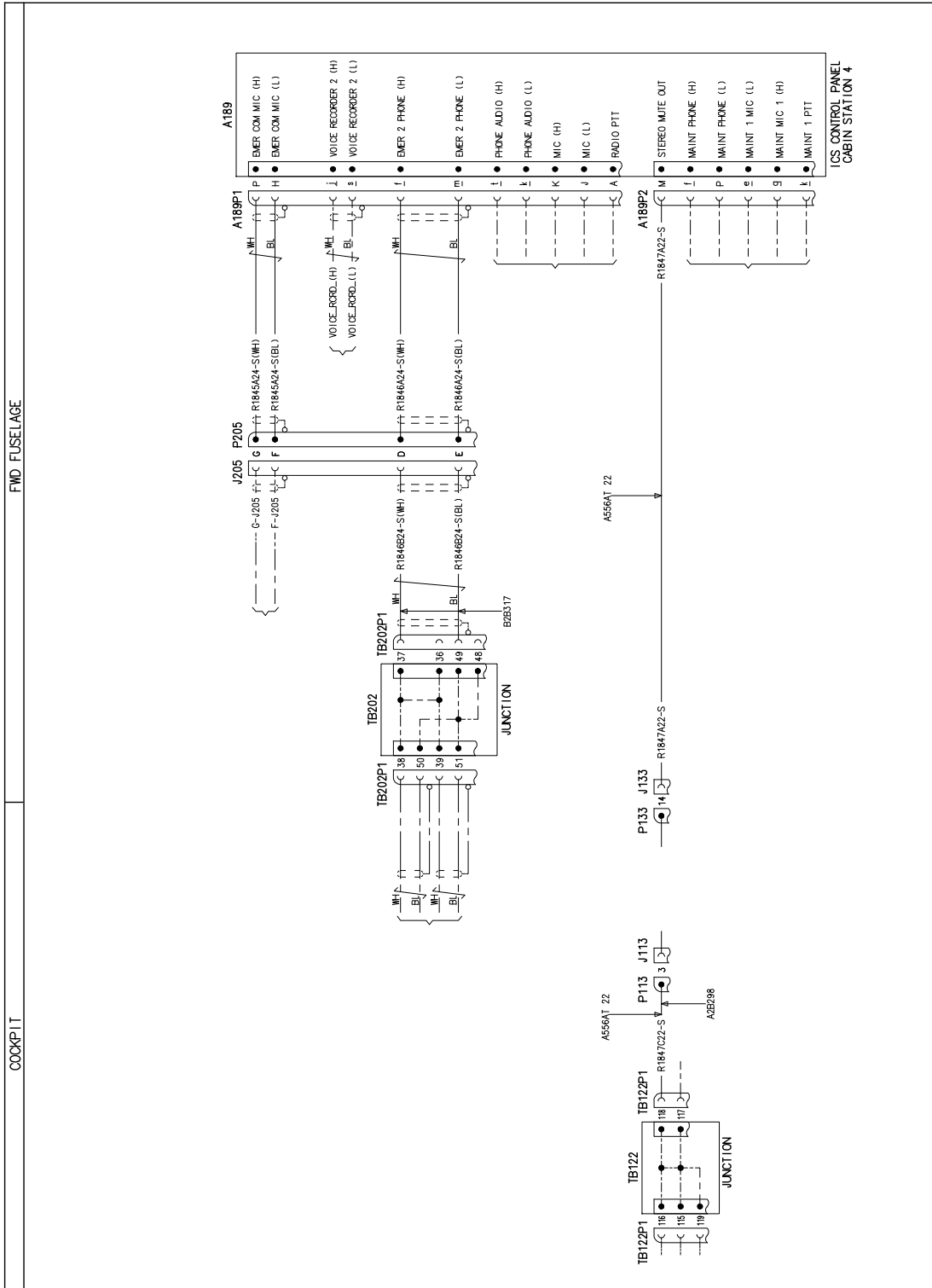

FUNCTIONAL NOTES

ALL CABLES ARE IN LOOM B2A299 UNLESS SPECIFIED.
ALL CABLES ARE OF TYPE A556/AT 24 UNLESS SPECIFIED

Figure 27

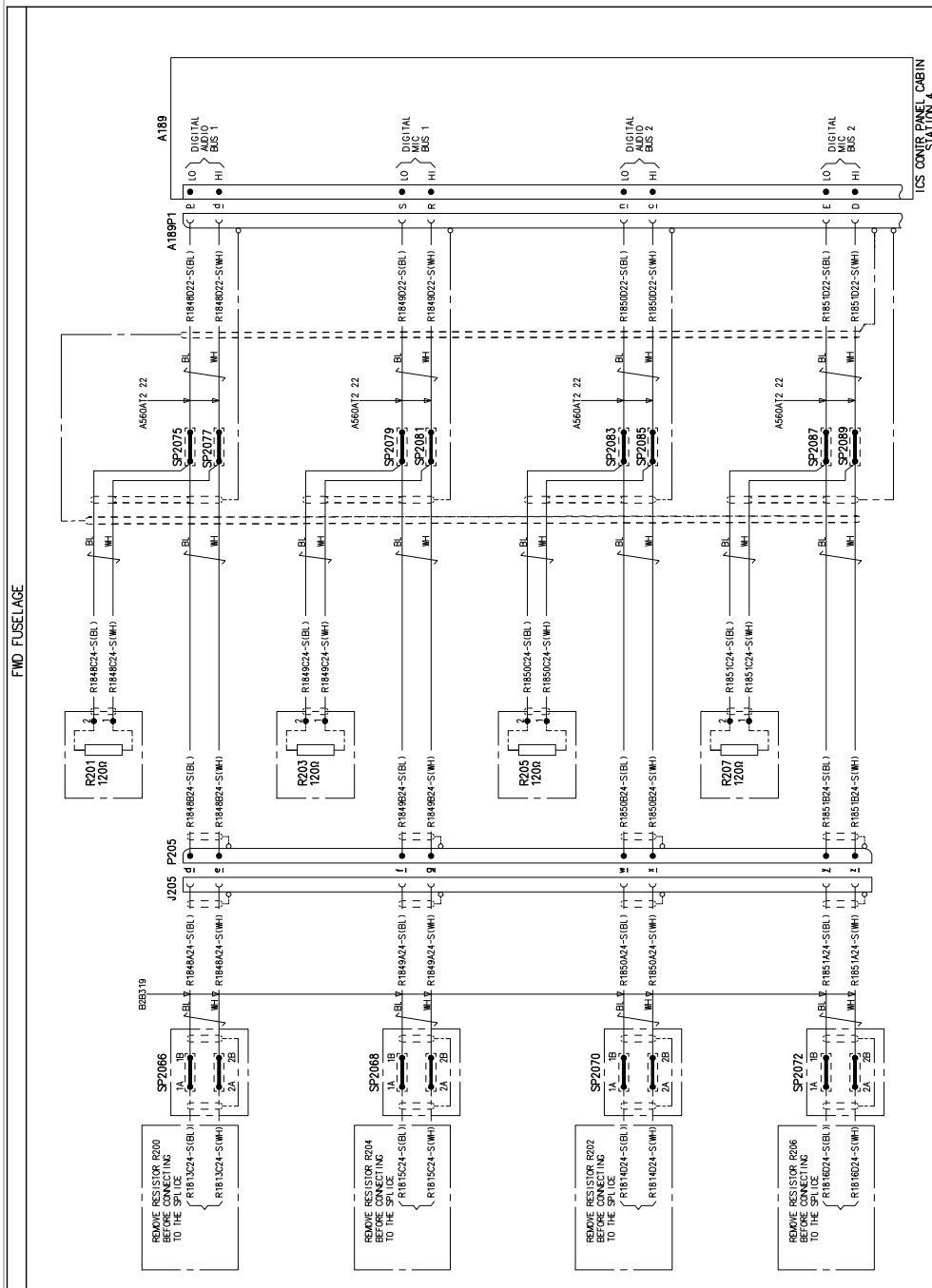

FUNCTIONAL NOTES

ALL CABLES ARE IN LOOM B2A301 UNLESS SPECIFIED.
ALL CABLES ARE OF TYPE 23240524-9 UNLESS SPECIFIED.

Figure 28

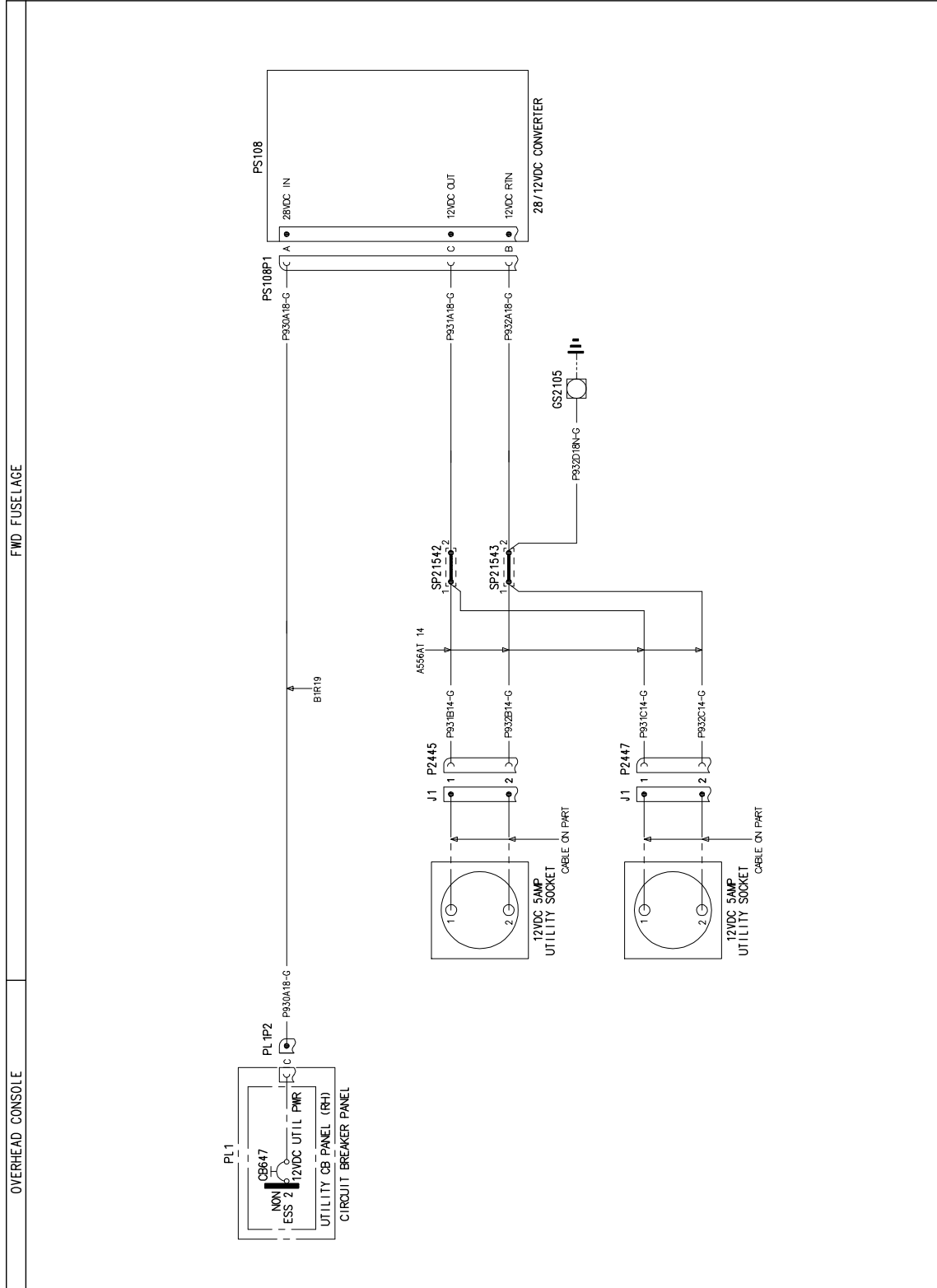

FUNCTIONAL NOTES
ALL CABLES ARE IN LOOM B11.171 UNLESS SPECIFIED
ALL CABLES ARE OF TYPE A556AT 18 UNLESS SPECIFIED

Figure 29

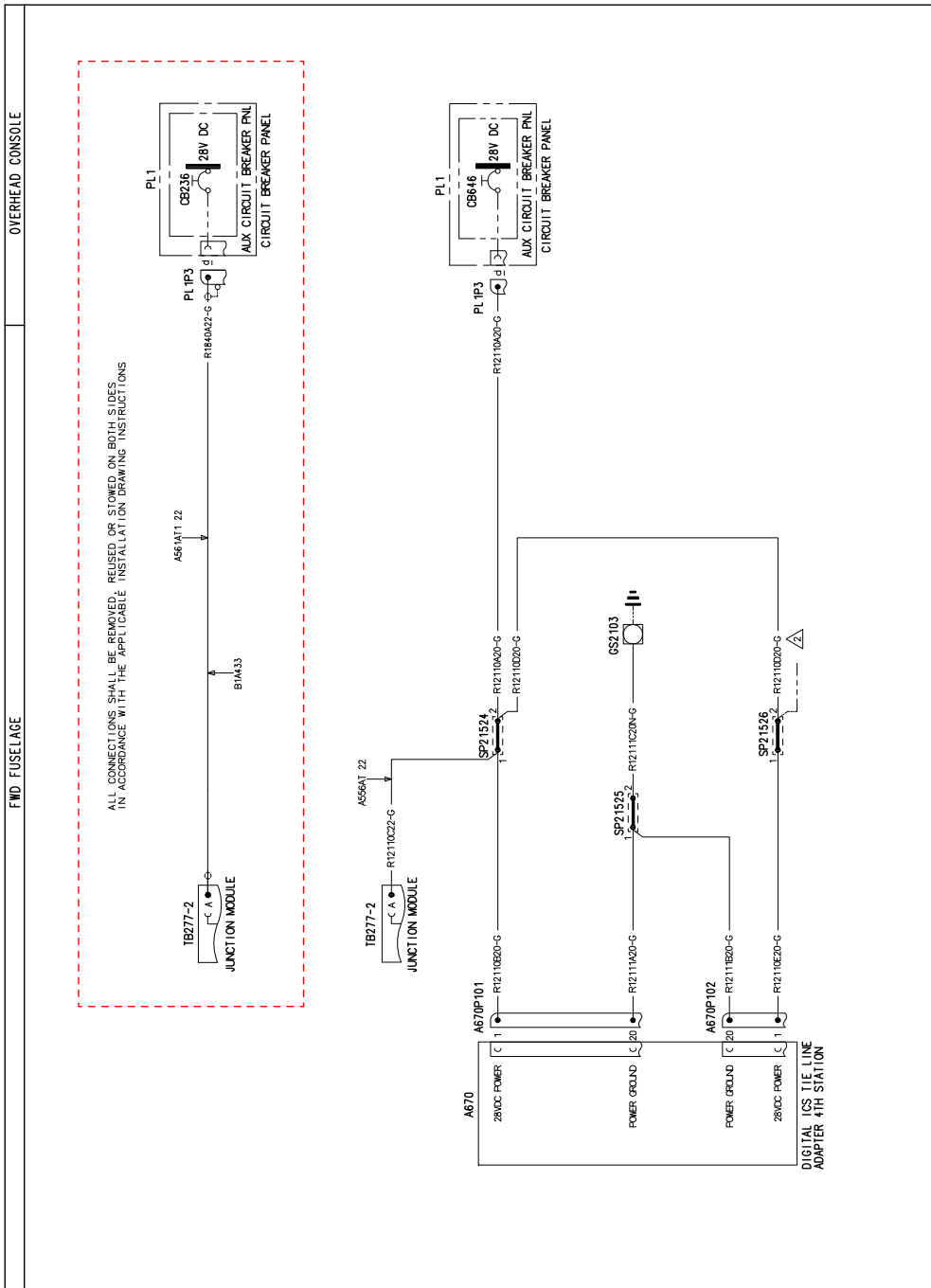
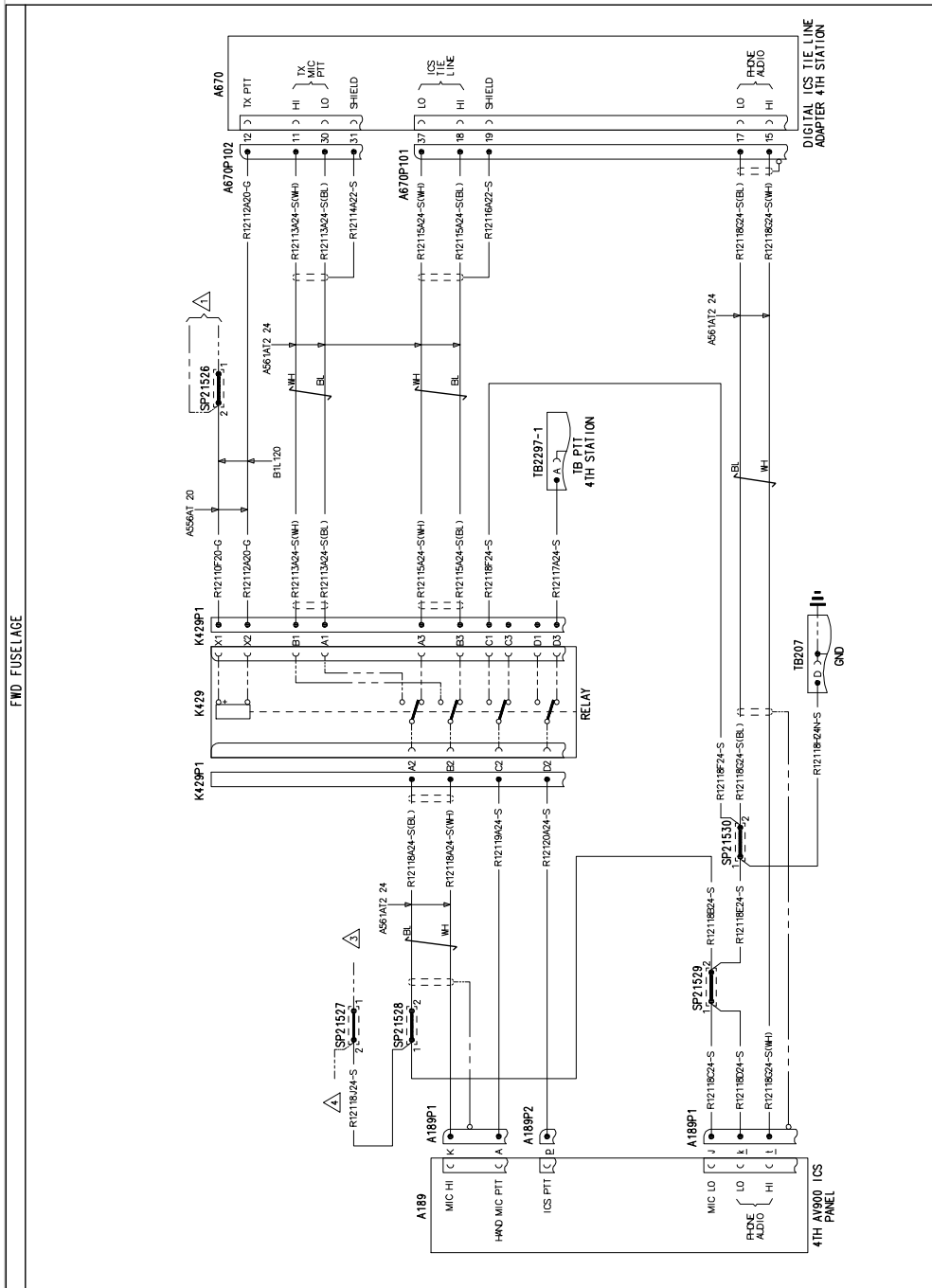

Figure 30

DRAWING REF. KEY
 △ SHEET NO.1
 ▽ SHEET NO.3
 ▽ SHEET NO.4



FUNCTIONAL NOTES
 ALL CABLES ARE IN LOM PDI.115 UNLESS SPECIFIED.
 ALL CABLES ARE OF TYPE A556AT 24 UNLESS SPECIFIED

Figure 31

DRAWING REF. KEY

- △ SHEET NO. 2
- △ SHEET NO. 4
- △ SCREEN LINK, 1
SHEET NO. 5

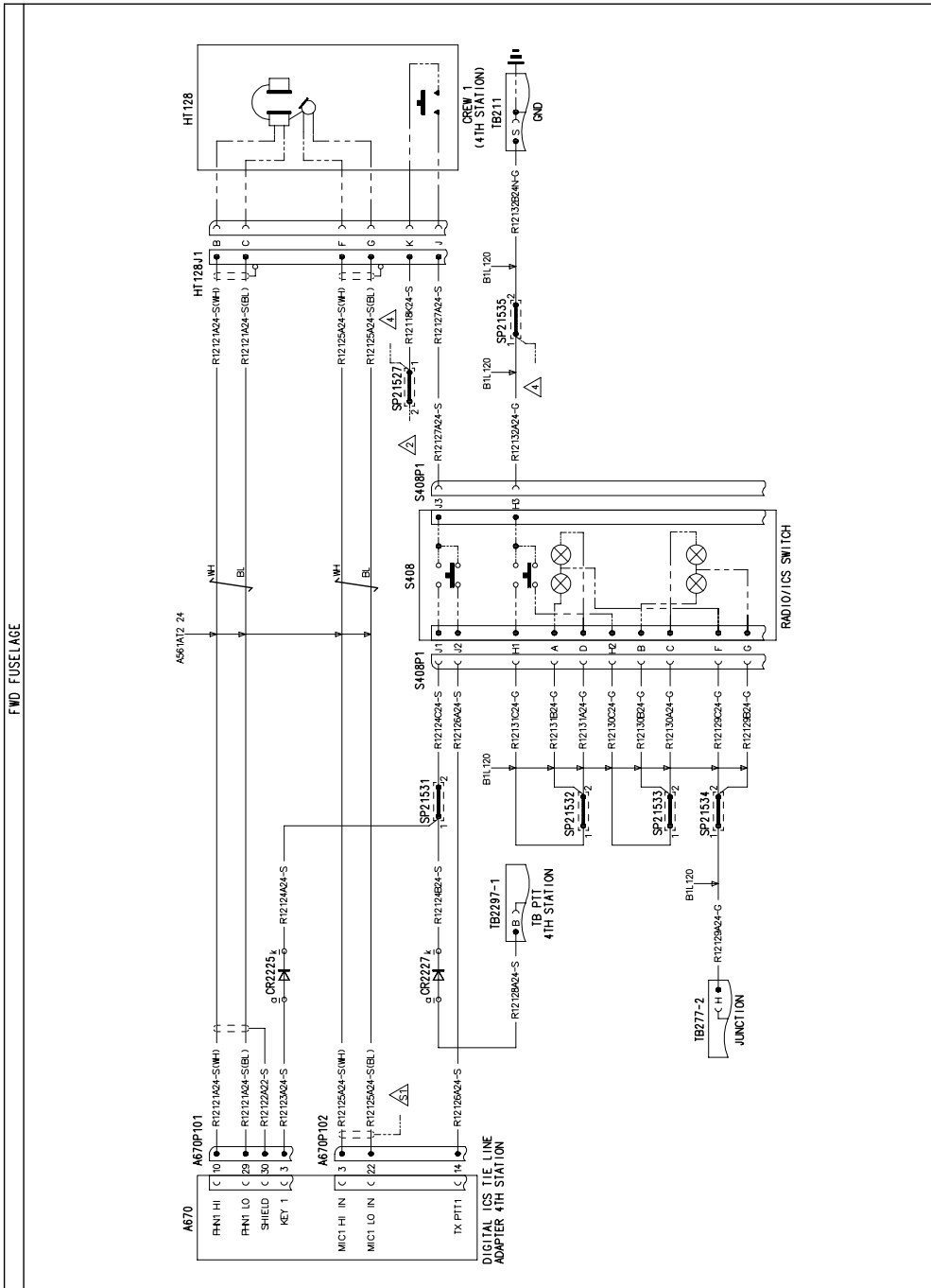



FUNCTIONAL NOTES

ALL CABLES ARE IN LOOM B01.115 UNLESS SPECIFIED.
ALL CABLES ARE OF TYPE ASS6AT 24 UNLESS SPECIFIED

Figure 32

DRAWING REF. KEY

-  SCREEN LINK 1
SHEET NO. 3
-  SCREEN LINK 2
SHEET NO. 4

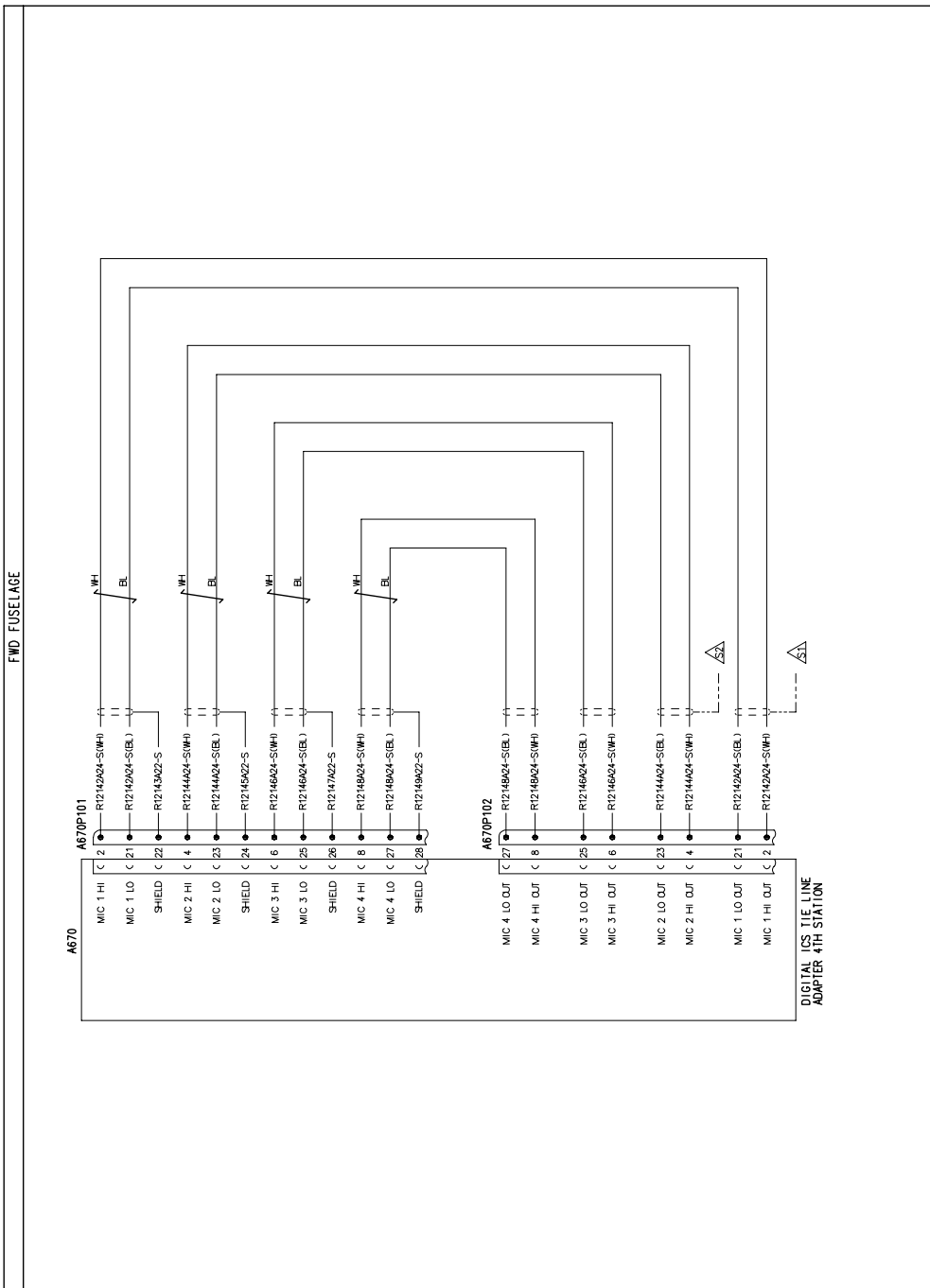

FUNCTIONAL NOTES

ALL CABLES ARE IN LOOM B2115 UNLESS SPECIFIED.
ALL CABLES ARE OF TYPE A361A12 24 UNLESS SPECIFIED

Figure 34

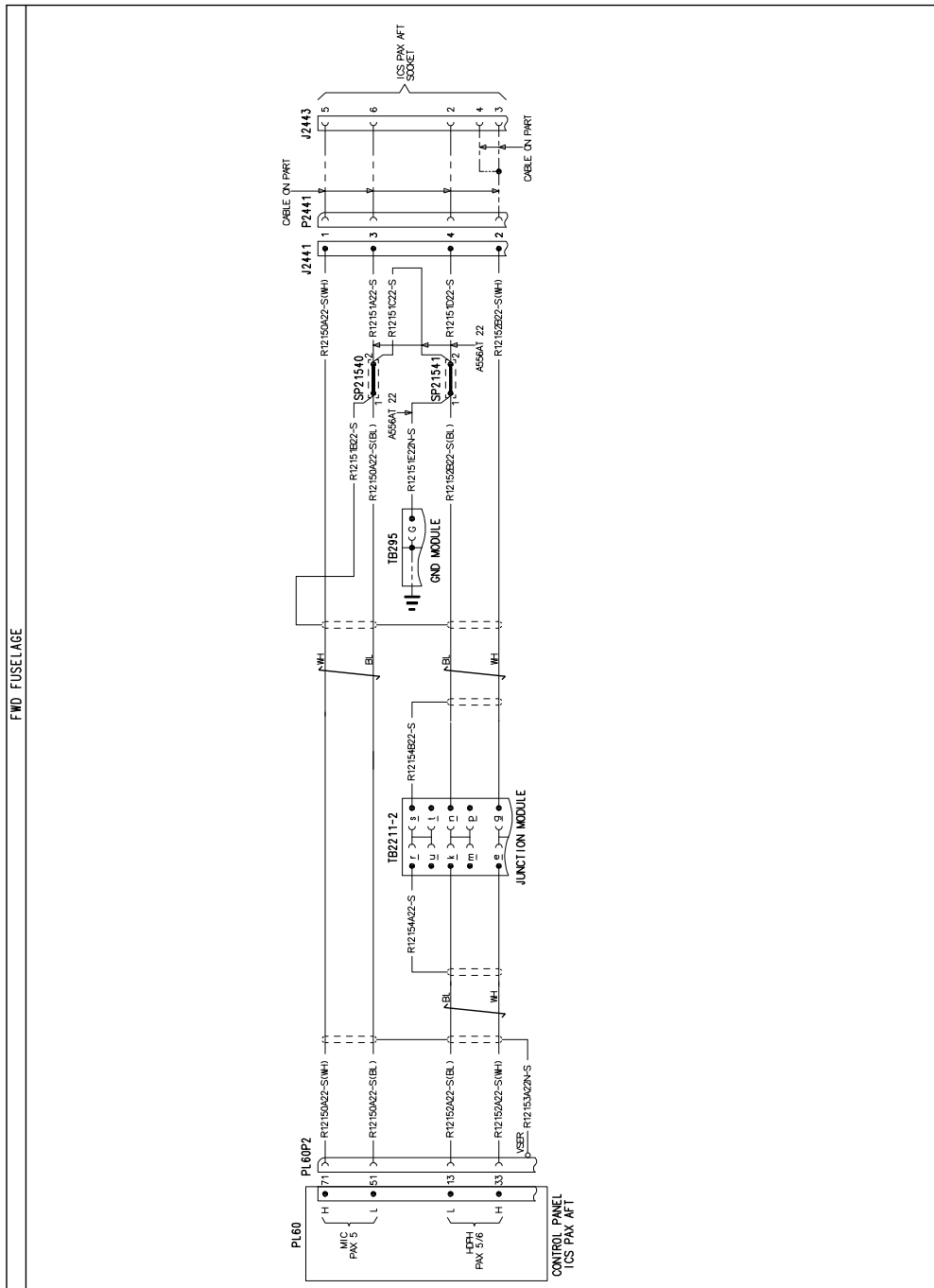

Figure 35

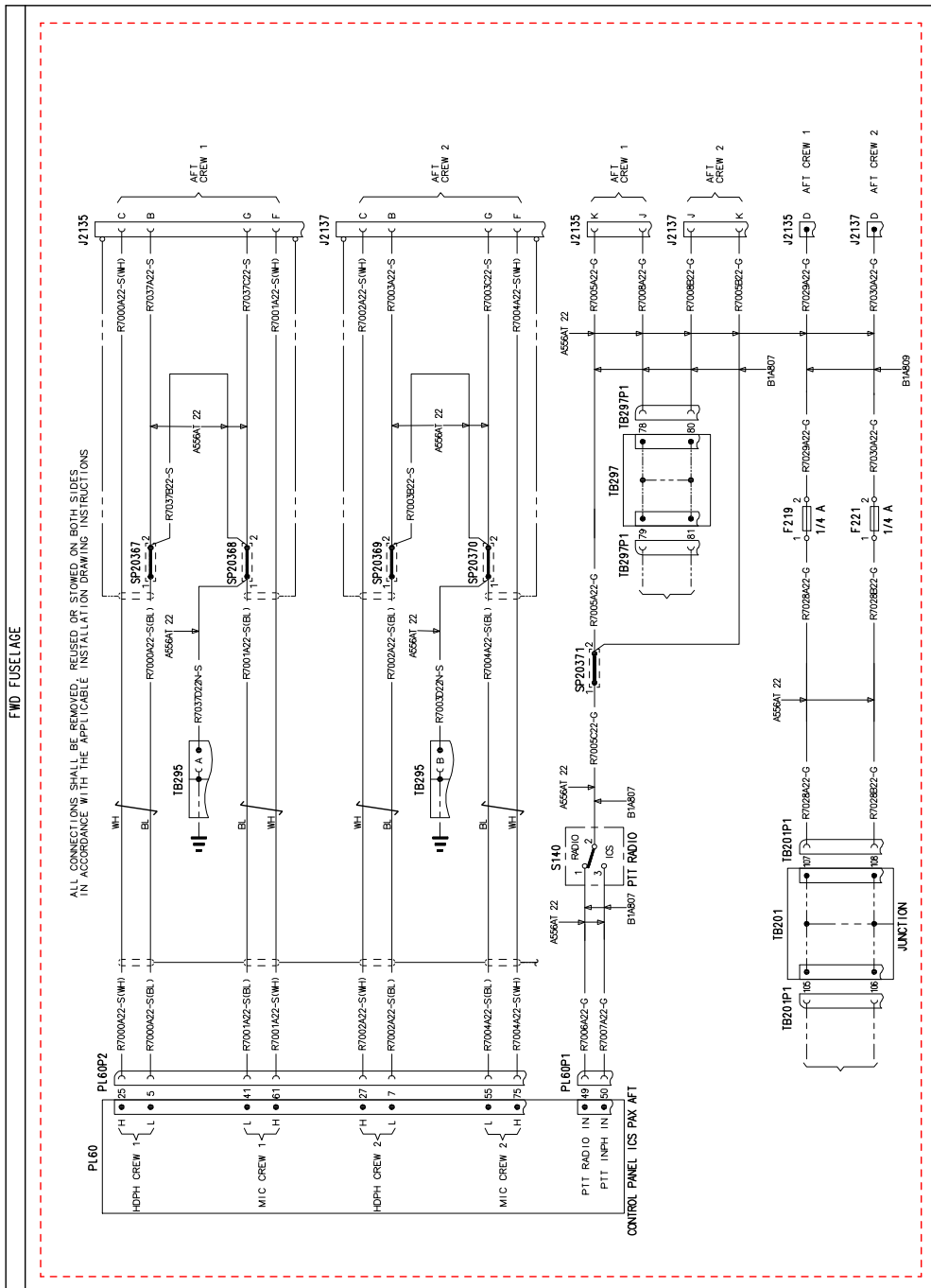
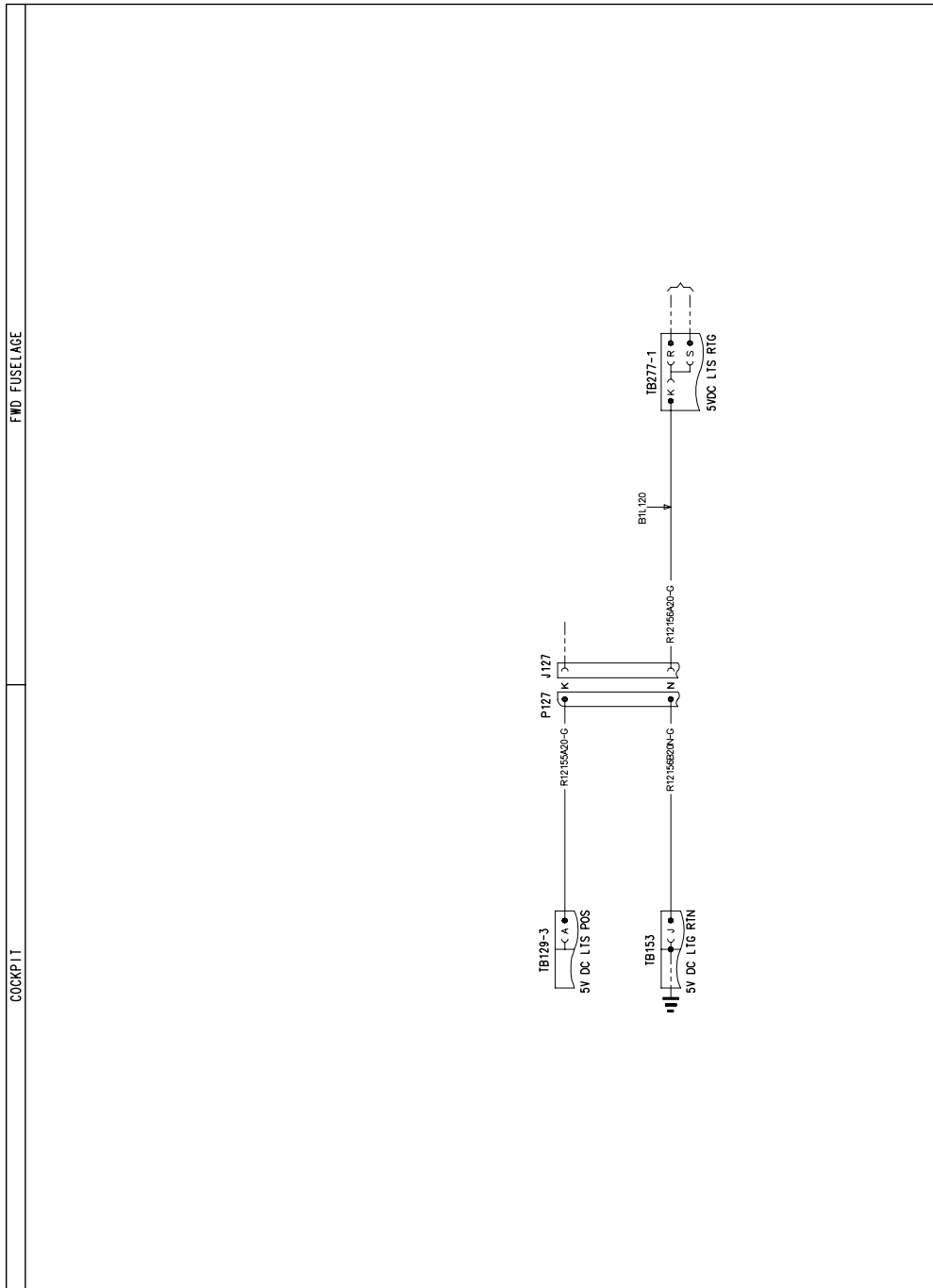

Figure 36



FUNCTIONAL NOTES

ALL LABELS ARE IN UOM A14682 UNLESS SPECIFIED.
ALL LABELS ARE OF TYPE A556AT 20 UNLESS SPECIFIED.

Figure 37

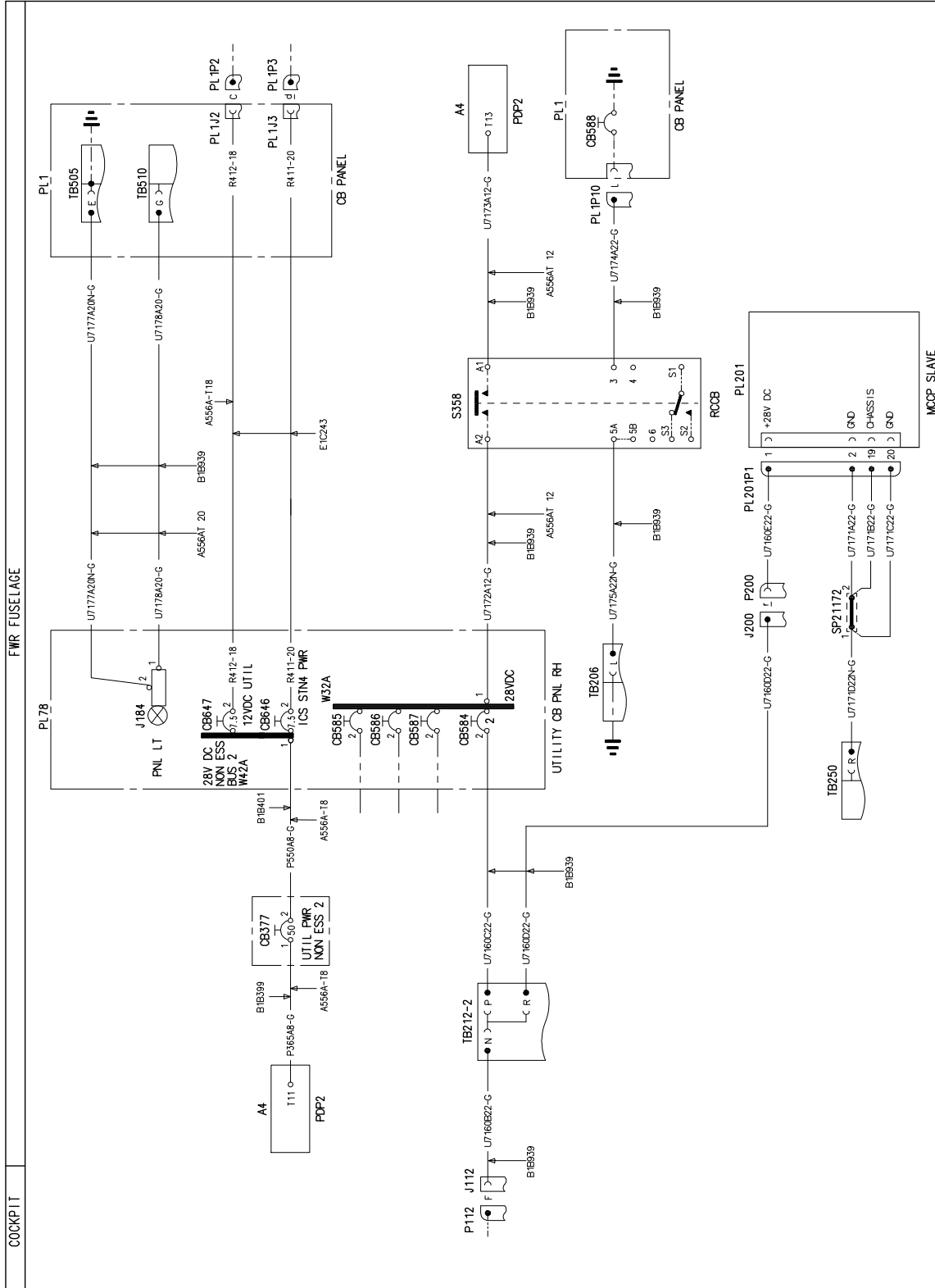

FUNCTIONAL NOTES

ALL CABLES ARE IN LOOM E1B940 UNLESS SPECIFIED.
ALL CABLES ARE OF TYPE A556A 22 UNLESS SPECIFIED

3G4620W01111
WIRING DIAGRAM MULTIPURPOSE CONT PNL (MCCP)
SHEET 3

Figure 40

CABIN LINERS RETROMOD FOR D.A.W. (FIBER)
3G2580P21111

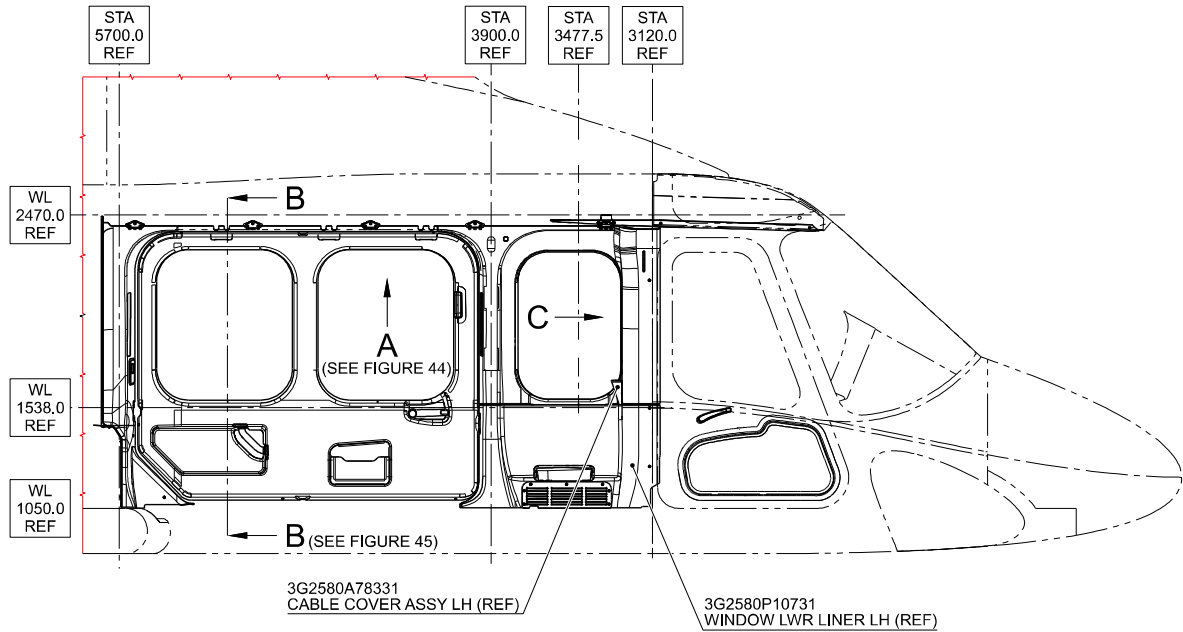

VIEW LOOKING OUTBOARD LH SIDE
PARTS OMITTED FOR BETTER CLARITY PURPOSE

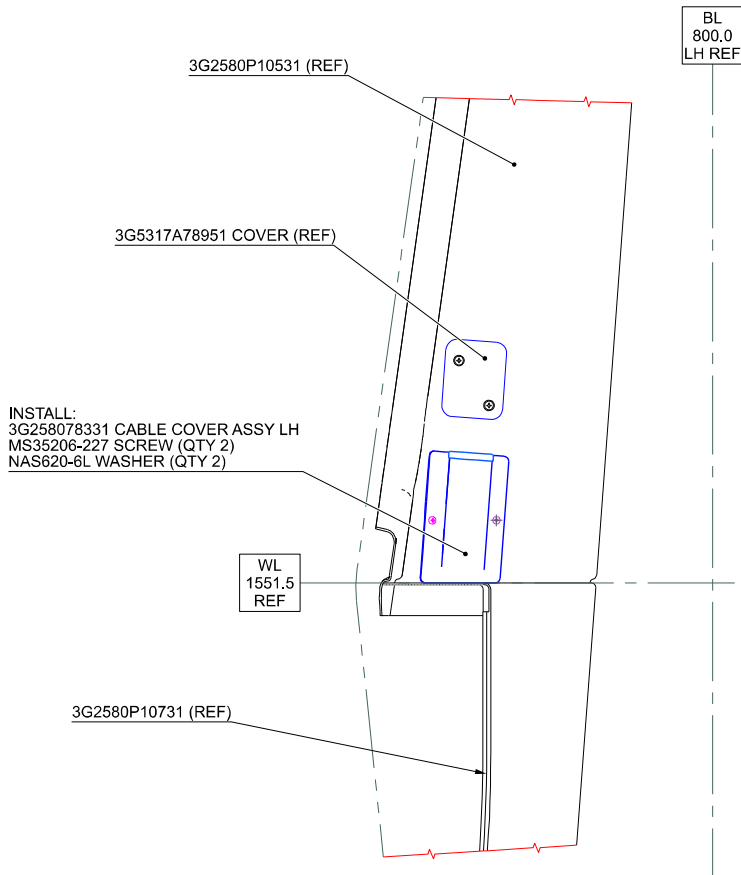

VIEW C
PARTS OMITTED FOR BETTER CLARITY PURPOSE

Figure 41

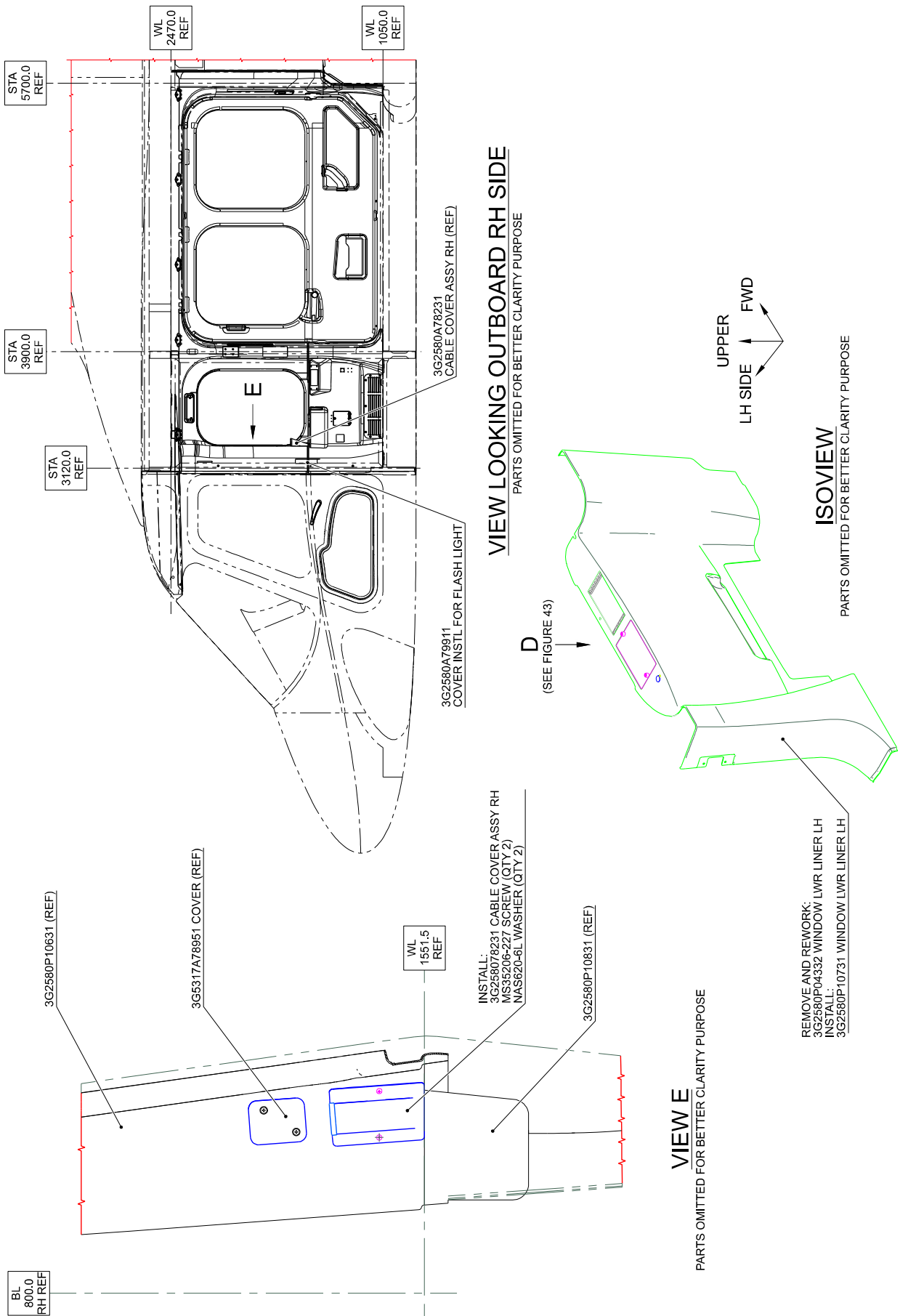

Figure 42

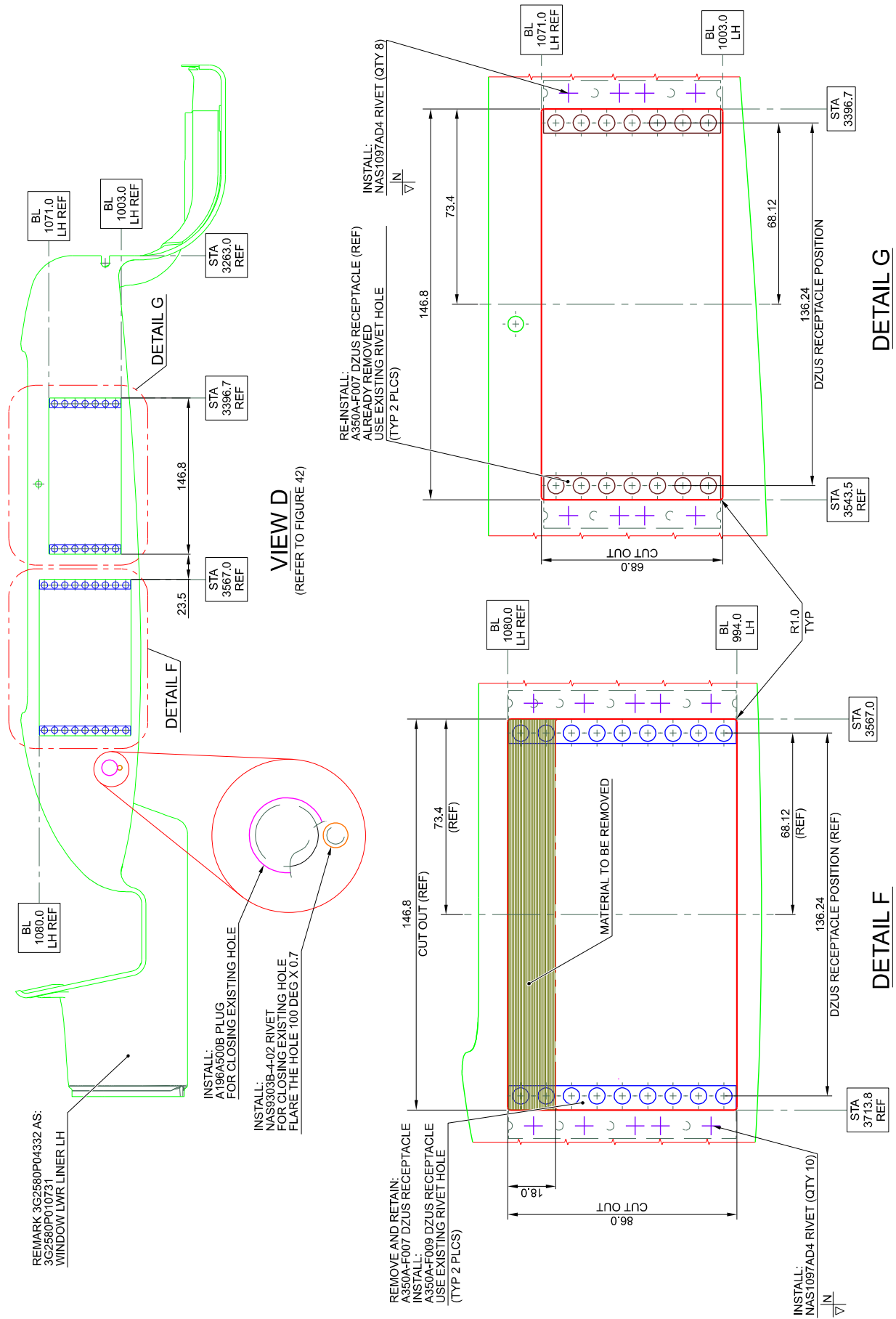

Figure 43

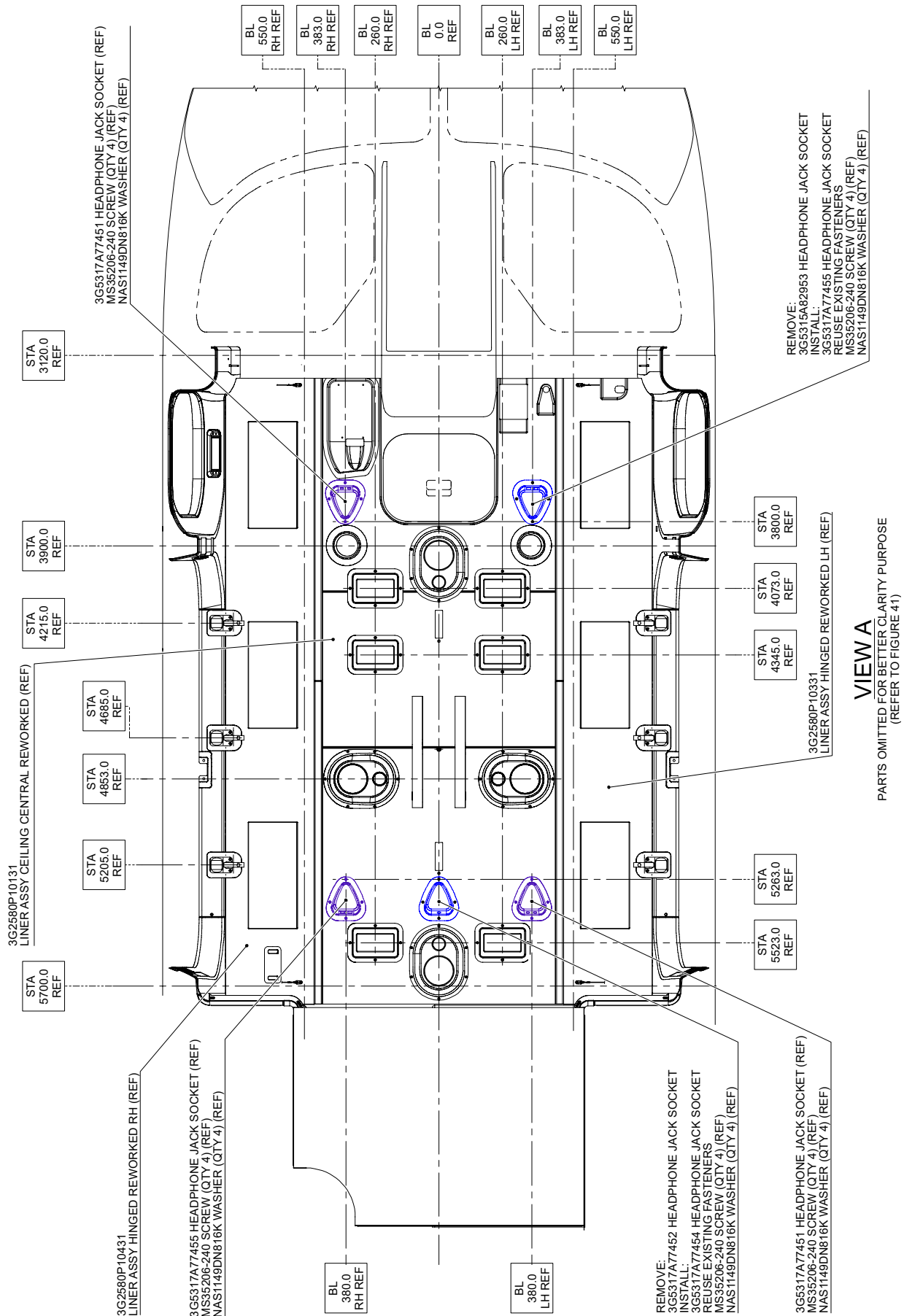
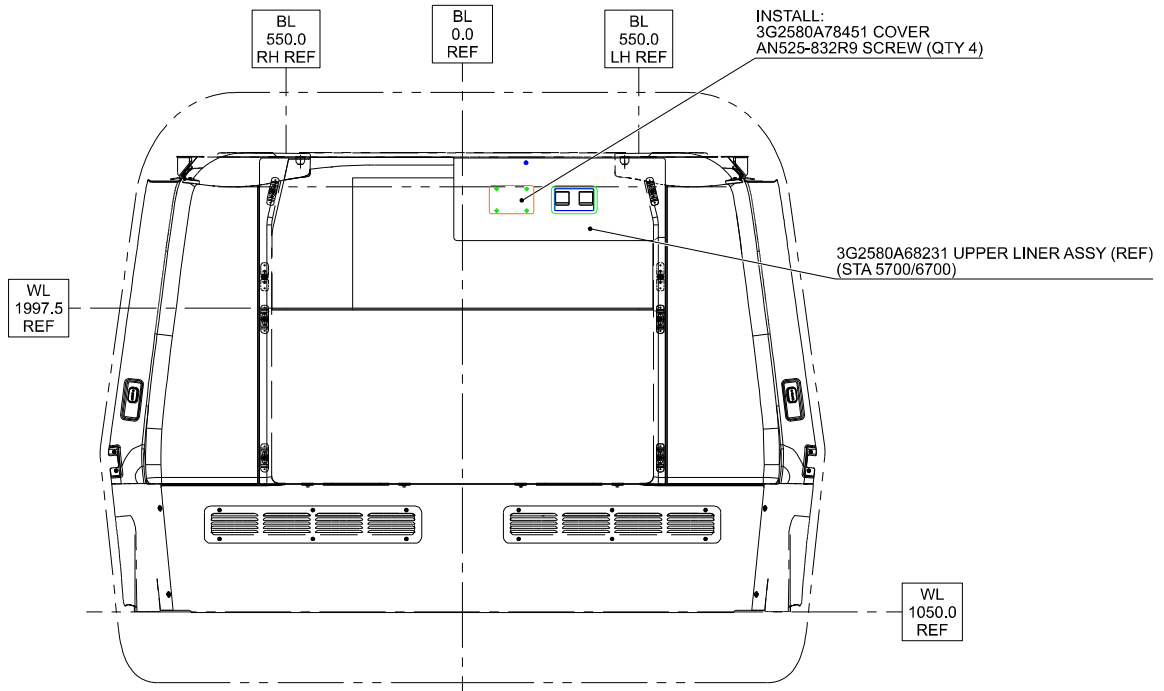
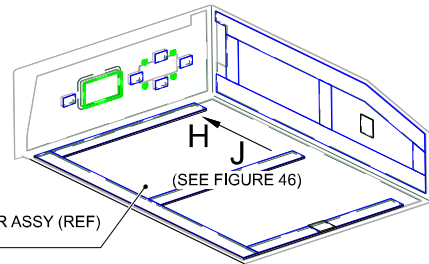

Figure 44



VIEW B-B
PARTS OMITTED FOR BETTER CLARITY PURPOSE
(REFER TO FIGURE 41)



ISOVIEW
PARTS OMITTED FOR BETTER CLARITY PURPOSE

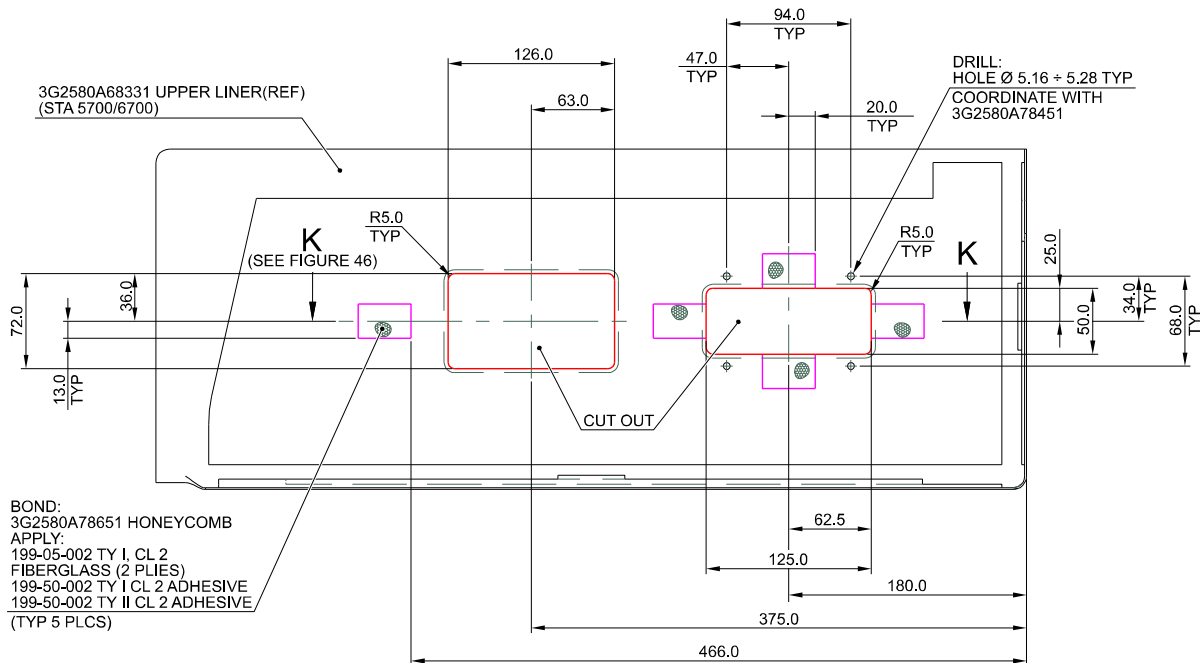

VIEW H
PARTS OMITTED FOR BETTER CLARITY PURPOSE

Figure 45

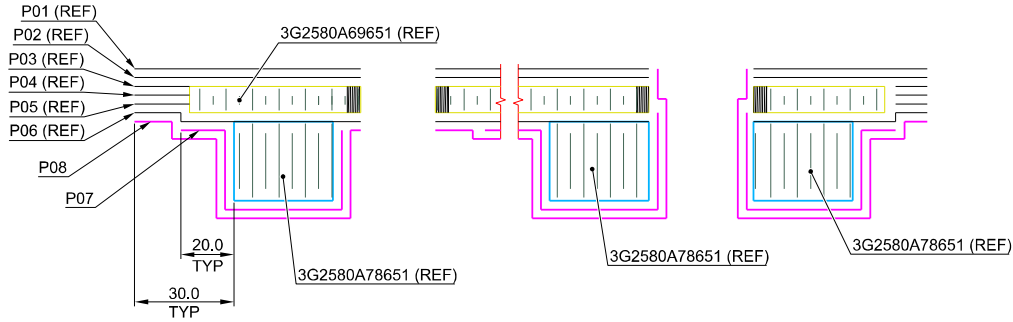

SCHEMATIC SECTION K-K
(REFER TO FIGURE 45)

LAY UP SEQ LEVEL	3G2580A68331 UPPER LINER						
	LAYER/PLY	QTY	ANGLE	SYM	MATL CODE	MATERIAL	MATERIAL SPECIFICATION/COMPONENT
1							3G2580A78651 HONEYCOMB (QTY 5)
2	P07		+45°	A	/7715-FB	EGL/EP FB	AWMS44-004 TYPE B FORM 7781
3	P08		-45°	A	/7715-FB	EGL/EP FB	AWMS44-004 TYPE B FORM 7781

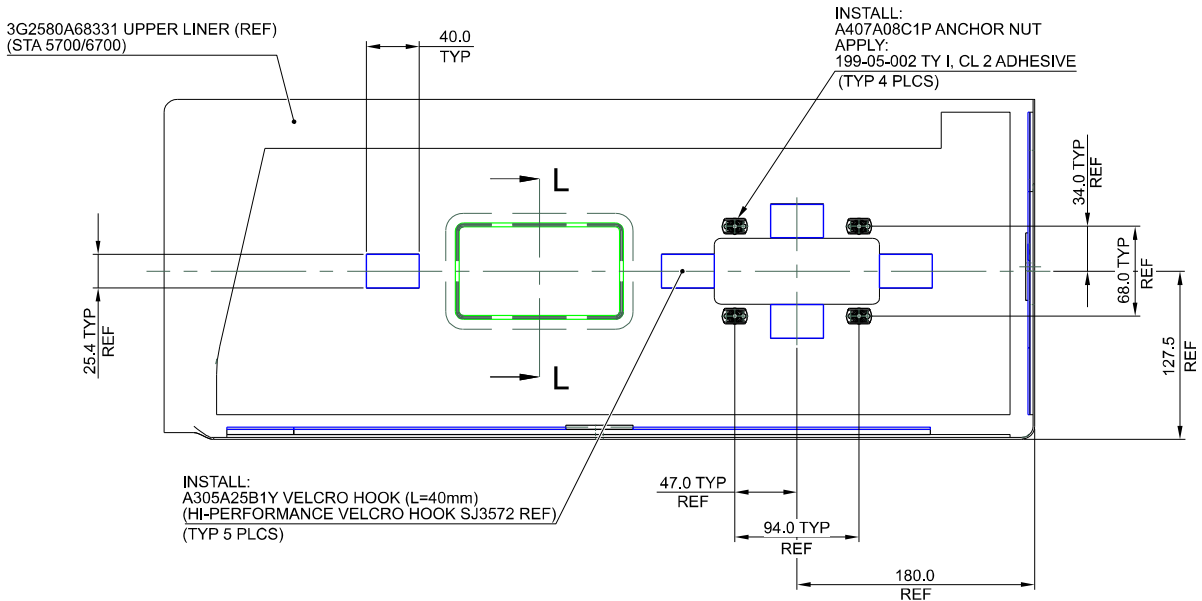

VIEW J
PARTS OMITTED FOR BETTER CLARITY PURPOSE
(REFER TO FIGURE 45)

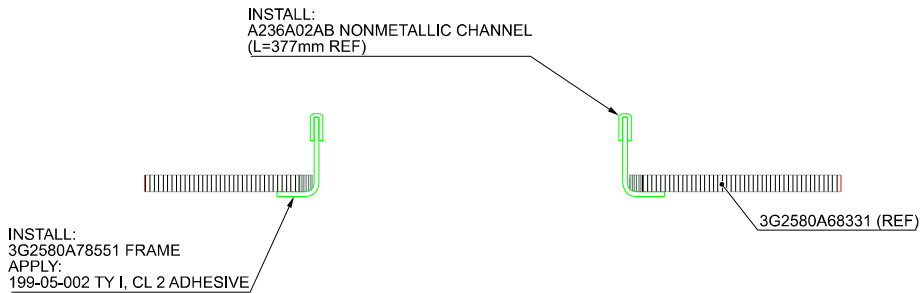

SECTION L-L

Figure 46

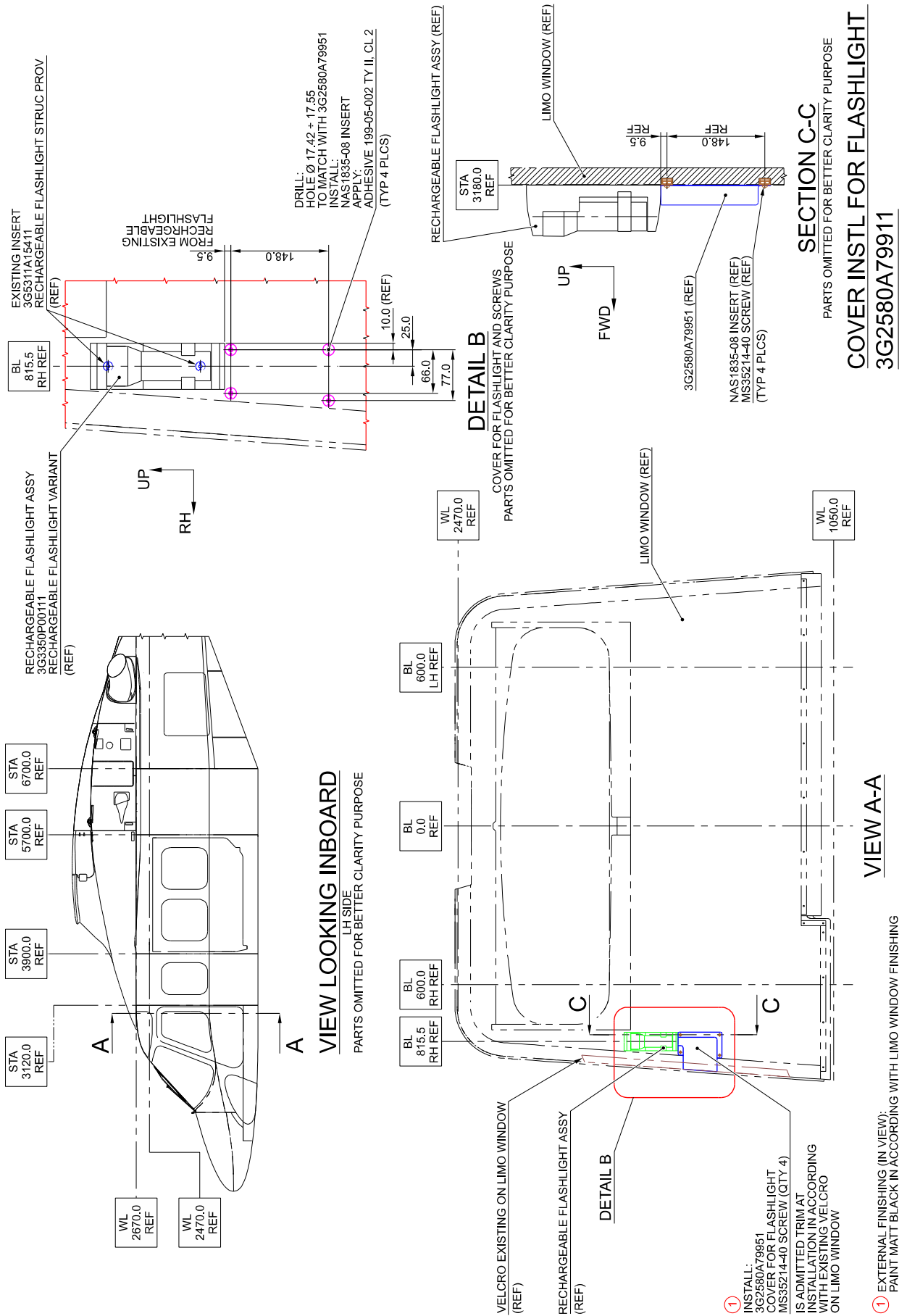
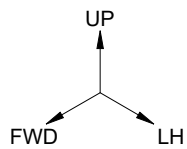
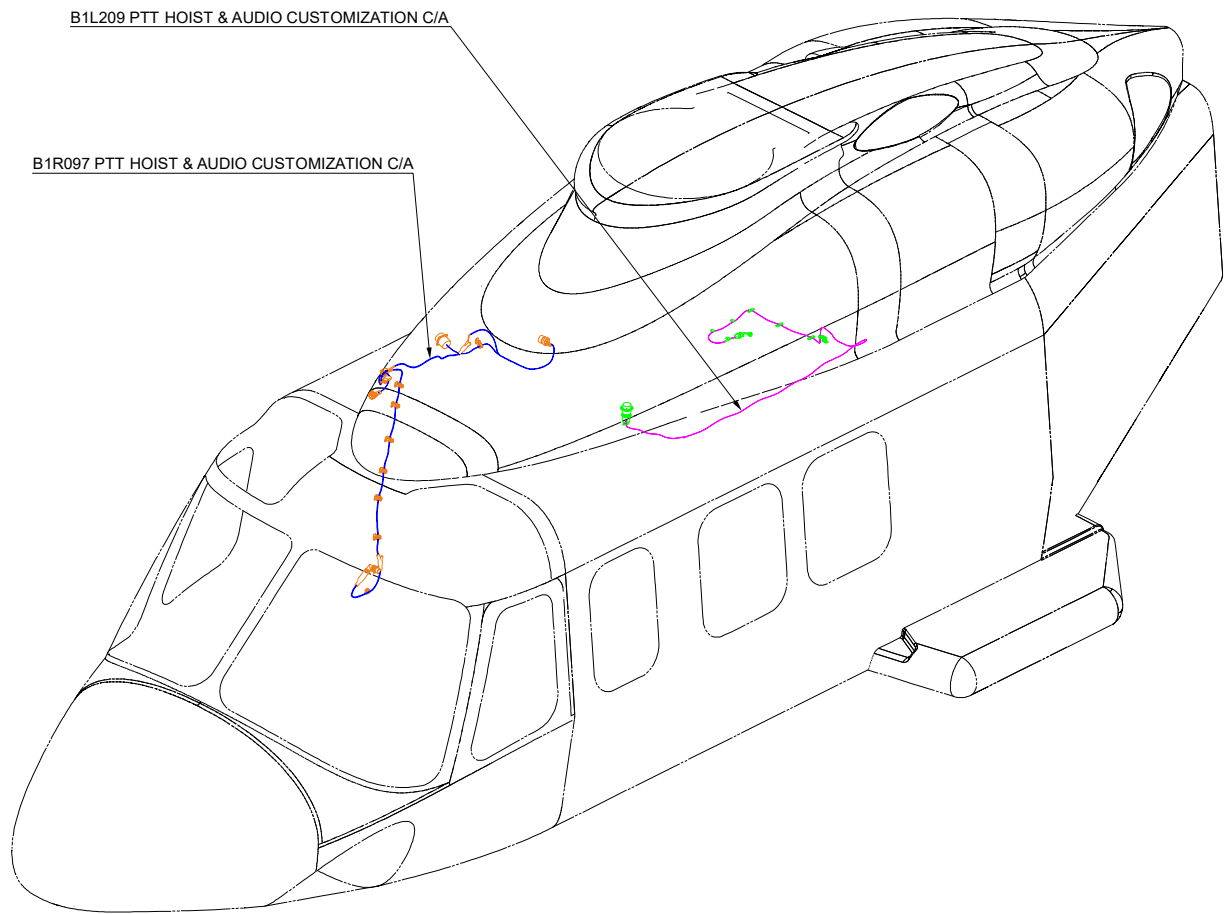

Figure 47



PTT HOIST & AUDIO CUSTOMIZATION UPGRADE
3G2350P06411

Figure 48

S.B. N°139-564
DATE: October 12, 2022
REVISION: /

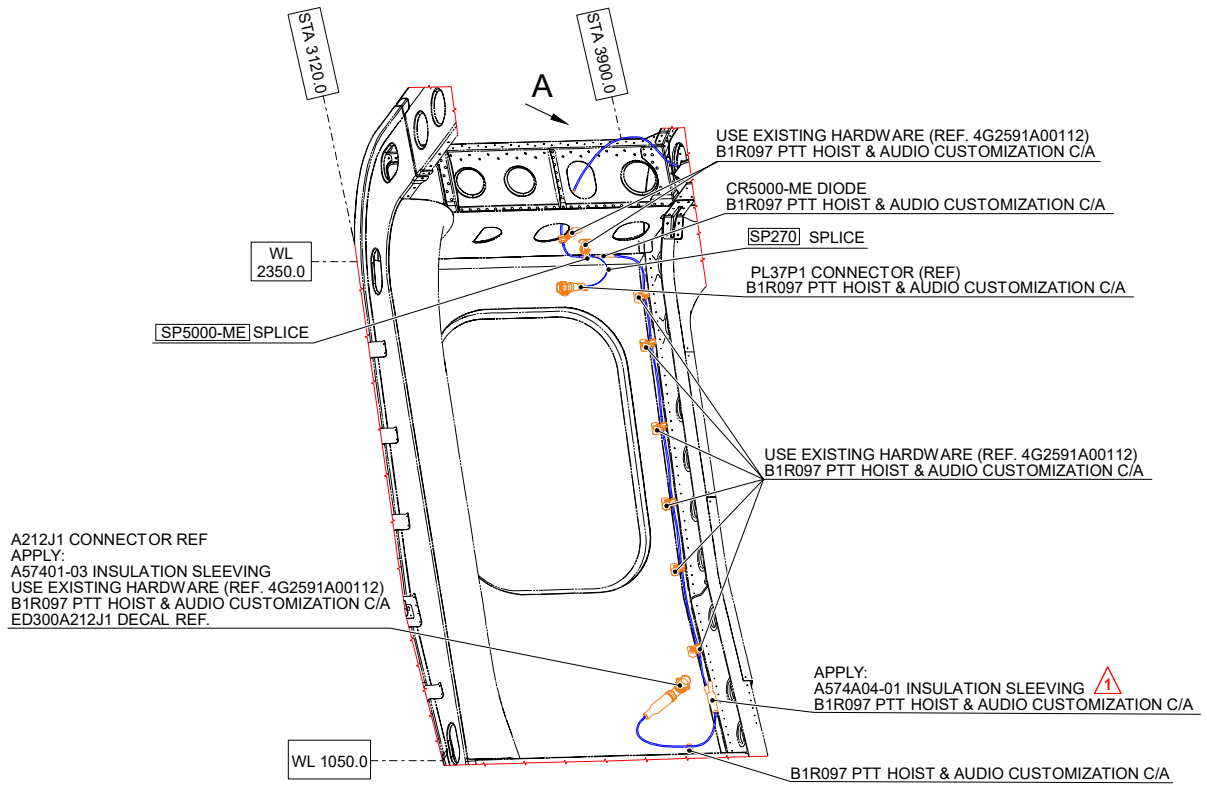

VIEW LOOKING OUTBOARD CABIN RH SIDE FROM STA 3120 TO STA 3900

STRUCTURE AND SYSTEMS ARE PARTIALLY OMITTED FOR BETTER CLARITY PURPOSE

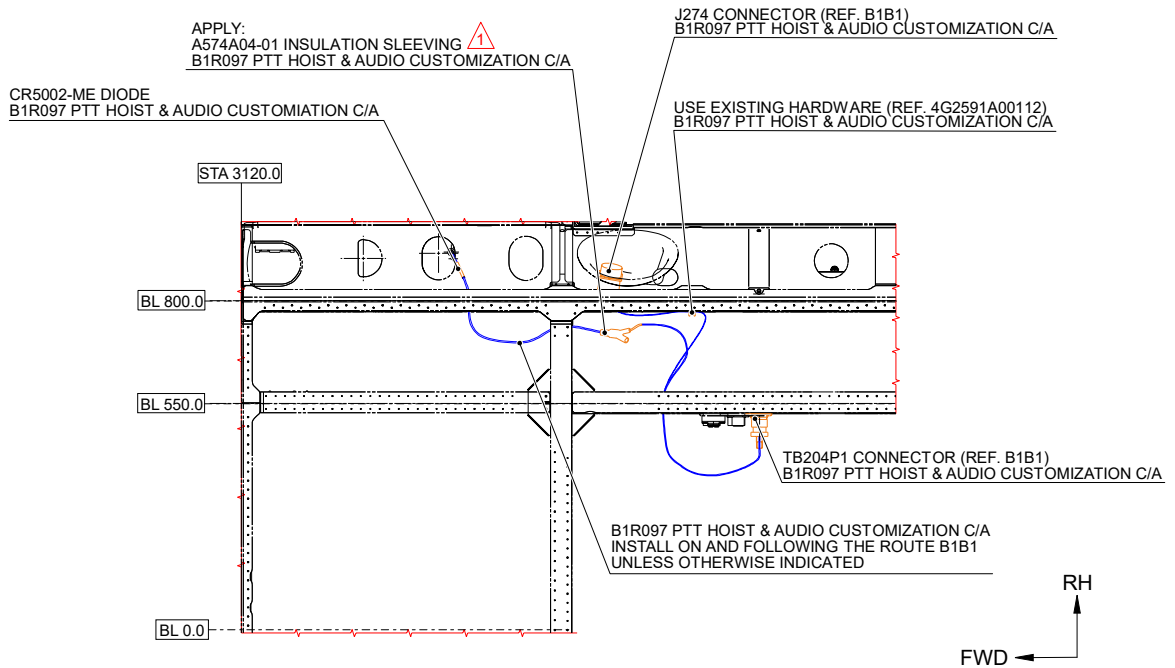

VIEW A

⚠ USE EXISTING BOOT OR REPLACE IT IN CASE IT IS DAMAGED

Figure 49

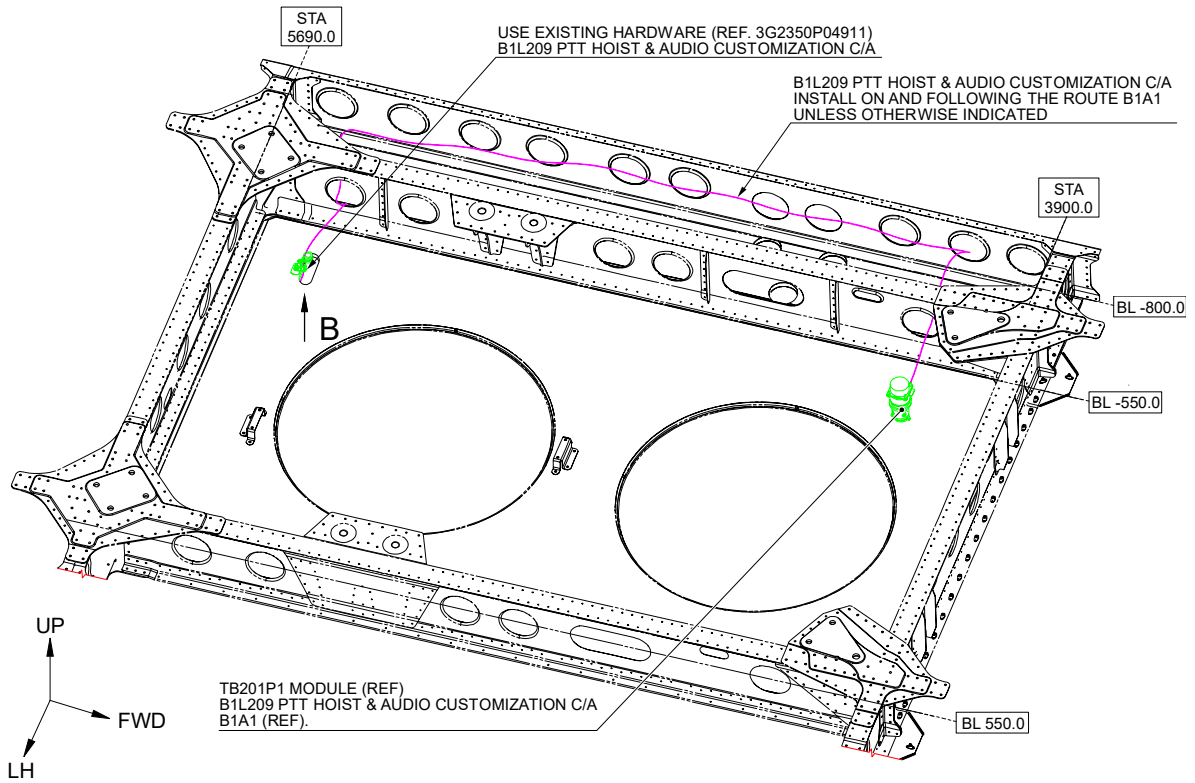

VIEW LOOKING DOWN ROOF LH SIDE FROM STA 3900 TO STA 5690

STRUCTURE AND SYSTEMS ARE PARTIALLY OMITTED FOR BETTER CLARITY PURPOSE

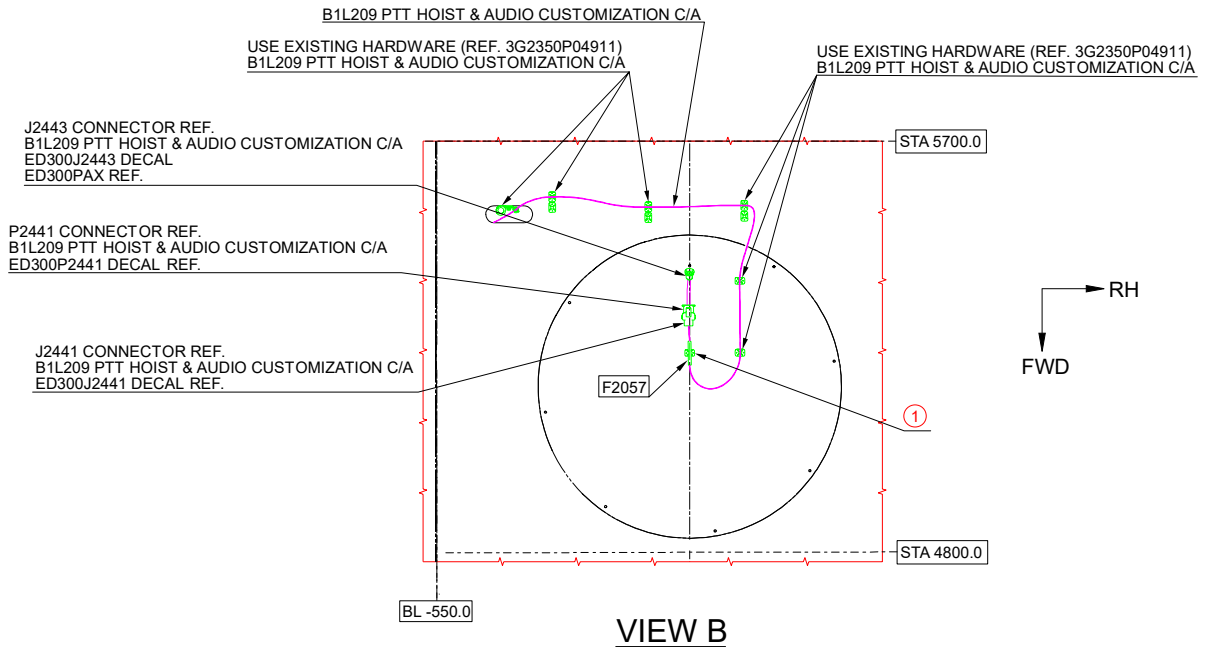

INSTALL ELECTRICAL SUPPORT REPORTED IN TABLE BELOW:

LOCATION NUMBER	PART. NUMBER	STA	BL	WL
①	AW001CL001-N6	5233	0	2467

Figure 50

S.B. N°139-564
DATE: October 12, 2022
REVISION: /

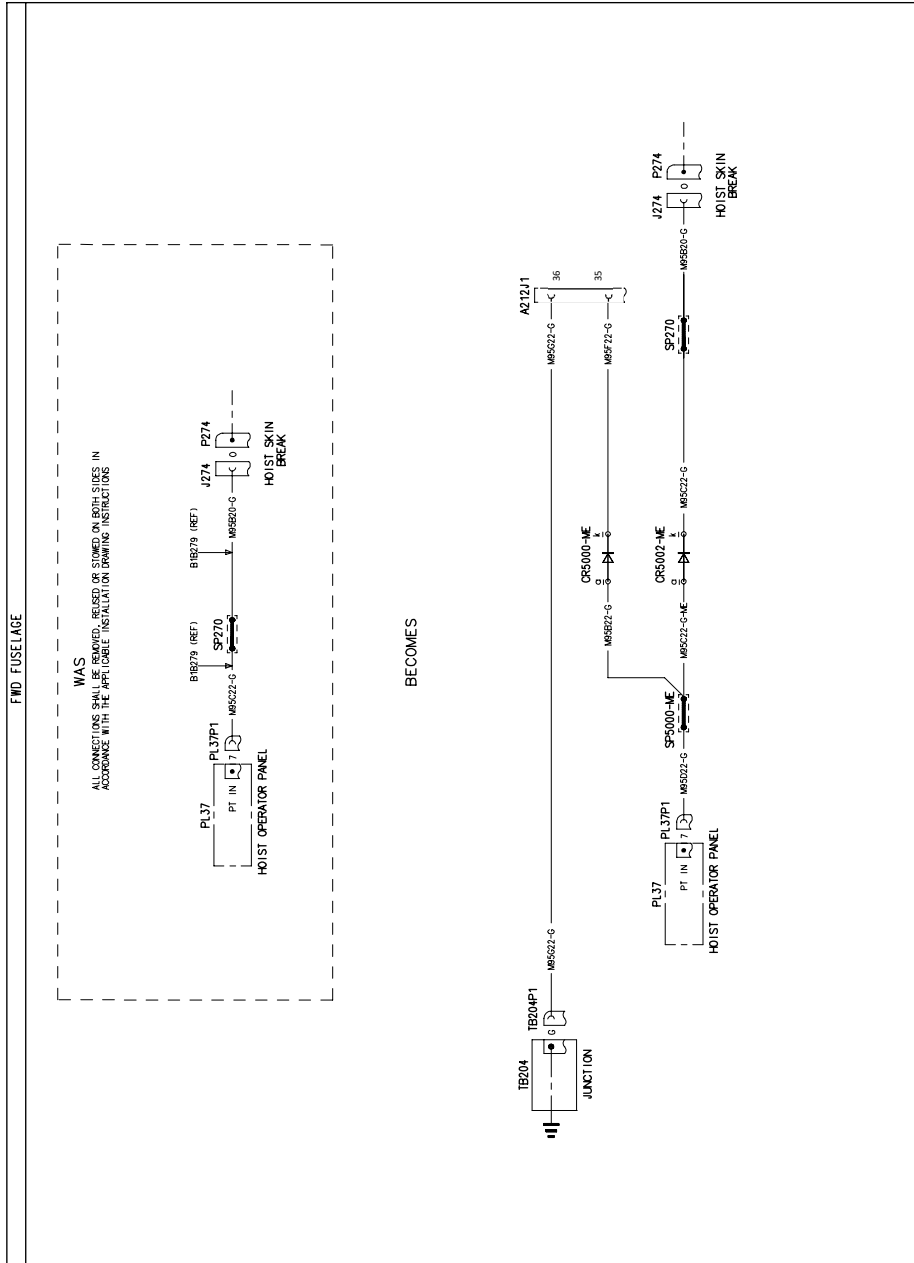

FUNCTIONAL NOTES
ALL CABLES ARE IN LOOM UNLESS SPECIFIED.
ALL CABLES ARE OF TYPE ASSIA 122 UNLESS SPECIFIED

Figure 51

FWD FUSELAGE

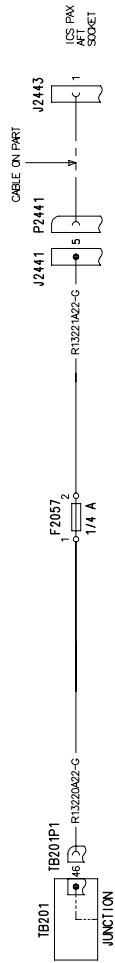

3G2350W16711
WIRING DIAGRAM PTT HOIST & AUDIO CUSTOMIZATION
SHEET 2

FUNCTIONAL NOTES
ALL CABLES ARE IN LOOM B11209 UNLESS SPECIFIED
ALL CABLES ARE OF TYPE AS56A1 22 UNLESS SPECIFIED

Figure 52

S.B. N°139-564
DATE: October 12, 2022
REVISION: /

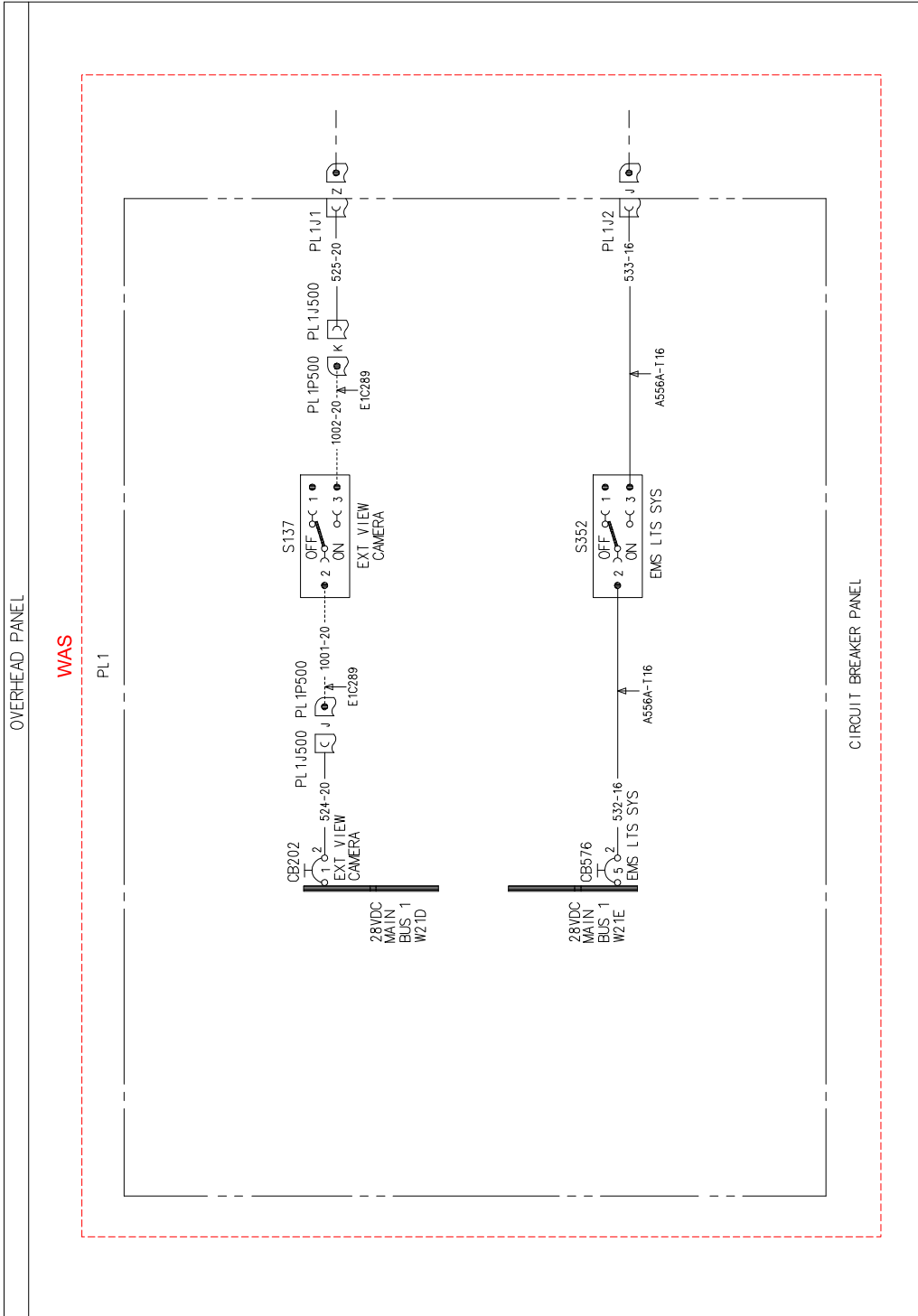

FUNCTIONAL NOTES

ALL CABLES ARE IN LOOM E1C290 UNLESS SPECIFIED
ALL CABLES ARE OF TYPE A556A-T20 UNLESS SPECIFIED

Figure 54

S.B. N°139-564
DATE: October 12, 2022
REVISION: /

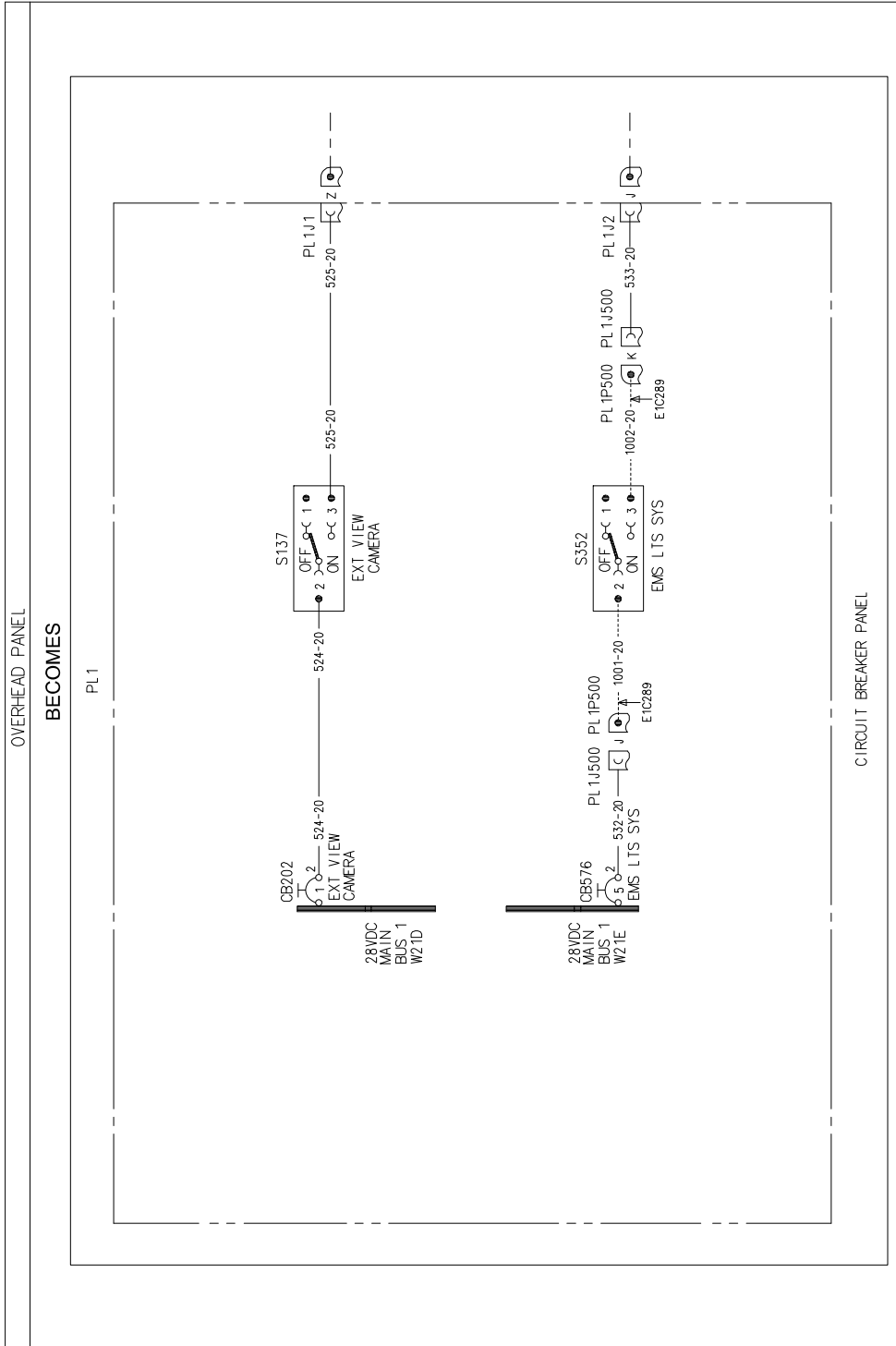

CRIMP ON WIRES THE ELECTRICAL CONTACT INDICATED

CABLE ASSY	WIRE		FROM REF-DES	ELECTRICAL CONTACT	TO REF-DES	ELECTRICAL CONTACT
	ID	COLL.				
E1C290	524-20	-	CB202	MS25036-149	S137	M39029/56-351
E1C290	532-20	-	CB576	MS25036-153	PL1J500	M39029/56-351
E1C290	533-20	-	PL1J500	M39029/56-351	PL1J2	M39029/56-351
E1C290	525-20	-	S137	M39029/1-102	PL1J1	M39029/56-351

FUNCTIONAL NOTES

ALL CABLES ARE IN LOOM E1C290 UNLESS SPECIFIED
ALL CABLES ARE OF TYPE A556A-T20 UNLESS SPECIFIED

Figure 55

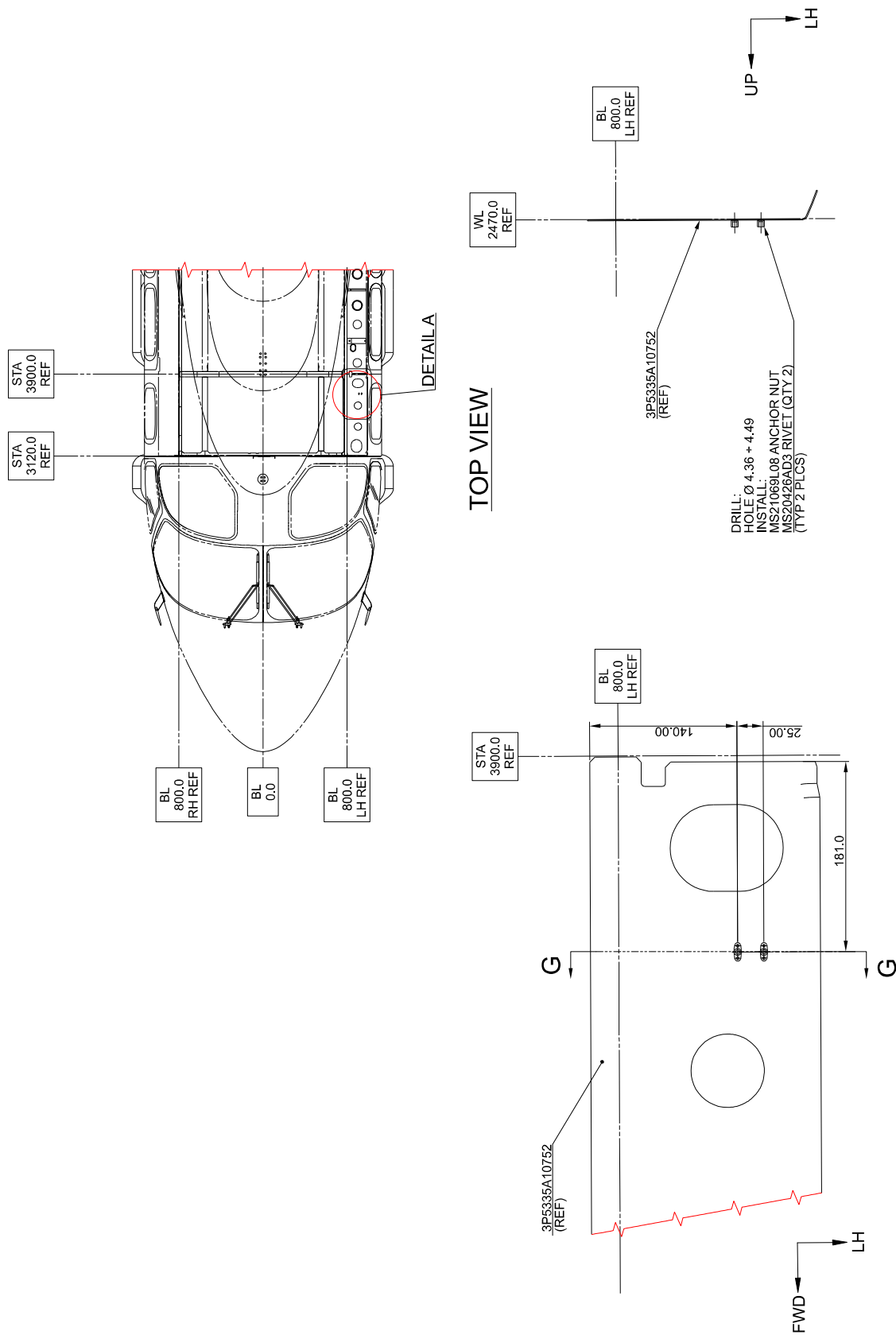

SECTION B-B

STRUCTURE AND SYSTEMS ARE PARTIALLY OMITTED FOR BETTER CLARITY PURPOSE

DETAIL A

STRUCTURE AND SYSTEMS ARE PARTIALLY OMITTED FOR BETTER CLARITY PURPOSE

Figure 57

ANNEX A

3G2350P04911 (DAW UPGRADE) SYSTEM TEST PROCEDURE

14 3G2350P04911 (DAW UPGRADE) SYSTEM TEST PROCEDURE

This section describes the TEST PROCEDURE to be applied, on ground, on Helicopters where the AUDIO System Customization 3G2350P04911 is installed.

14.1 TEST EQUIPMENT

- DC External Power Bench (28VDC).
- DC Voltmeter (range 0-32 VDC).
- Six Headsets Kit min.
- Conductor Pins and Wire Extensions for troubleshooting operation.
- Audio Frequency Signal Generator (1KHz @ 500mVrms output sinusoid) P/N TALL6300T1A690F or similar
- Oscilloscope (maximum operating frequency 100MHz as minimum) or multimeter P/N TALL2400M1A690A
- Testing cable to be used with multimeter (see APPENDIX B)
- Testing cable to be used with oscilloscope and generator (tool P/N TME392350AA00 or equivalent, see APPENDIX B for instruction)

INSTRUMENT PRECISION: +/- 2% MIN

14.2 TEST PREREQUISITES AND SAFETY PROVISION

1. Visually verify the proper installation of all the components. Check the correct mechanical installation and fixing; Check the Electrical wires installation; Check that all the connectors are properly plugged and fastened. Use the drawing in ref.[Q], [R] as reference documents.
2. AW139 - AVIONICS ACCEPTANCE TEST PROCEDURE, ref. [CC] successfully completed.
3. Verify that the Primus Epic S/W 4.8 or following release is installed.
4. Verify that the APM option file with "*audioPan4installed*" enabled is installed to enable all the cabin Audio panels in the cabin. Refer to the procedure described in the document: "AW139 – PRIMUS EPIC® Software Installation Procedure: 139G4600M001" ref.[DD].
5. Verify the following setting selection. If required configure with the APM tool the setting file with the selections:
 - **Number of Cockpit Audio Panels = 2**
6. Verify that in the MFD System Config pages that the Number of Cockpit Audio panels is correctly uploaded to number 2 panels.
7. During the test with helicopter electrically powered, the "IGN #1/2" and "START #1/2" breakers shall be pulled out.

14.3 ELECTRICAL SETTINGS

1. Verify that all the Electrical Power Distribution System Circuit Breakers are pushed in;
2. Verify that all the Avionic Devices Circuit Breakers are pushed in;
3. The helicopter external power port shall be connected to the External Power Bench set to 28 VDC output. Power up the External Power Bench before starting with the test procedure.

14.4 PRELIMINARY CHECKS

14.4.1 INSTALLATION AND POWER SUPPLY CHECKS

1. Pull out CB646 and all AV900 Cabin circuit breakers.
2. Disconnect all the Cabin Headsets and relevant extensions and the connectors: A670P101/P102, A189P1/P2. Use the drawing in ref. [Q], [R] as reference documents.
3. With the helicopter powered off verify the proper bonding of the following components:

- **AA38-603 units (A670):**

Take the (-) negative pole on GND point on local structure.

All metal parts not associated with the Unit electric functions and electrically connected together (for example mounting tray) and point of GND on local structure.	Measured		Max 10mΩ
	A670:	mΩ	

4. Push in the CB646 and all AV900 circuit breakers.
5. Verify, the grounding of the pins: A670P101-20 and A670P102-20.
6. Verify, the grounding of the pins: HT128J1-K, HT129J1-K, J2443-2, J2443-6
7. Verify the grounding of the pins: S408P1-H3, S409P1-H3.
8. Verify the 28VDC signal between the pins A670P101-1(+) and A670P101-20(-).
9. Verify the 28VDC signal between the pins A670P102-1(+) and A670P102-20(-).
10. Verify the 28VDC signal between the pins K429P1-X1(+) and GND point on local structure.
11. Verify the 28VDC signal between the pins: S408P1-F(+), S408P1-G(+) and S408P1-H3(-).
12. Pull out all the CBs and reconnect all the connector of the LRU under test. Use the drawing in ref. [Q], [R] as reference documents.
13. Push in all the CBs.

14.5 SYSTEM TEST PROCEDURE

The following paragraph describes the Test Procedure to be applied on the system customization linked to the 4th AV900.

For the system customization linked to the kit ICS Cabin Utility (8 Pax - GEMELLI), consisting on the removal of Crew headsets, refer to dedicated ATP document 139G2350D008. Note that the test steps applicable to operator's positions have to be skipped.

14.5.1 AA38-603 ADJUSTMENT

The unit is shipped with all internal adjustments set to the normal test levels. In order to verify and adjust the internal AA38-603 settings is necessary to access to the adjustment holes, located along the sides of the unit.

1. Mode Control switch adjustment.

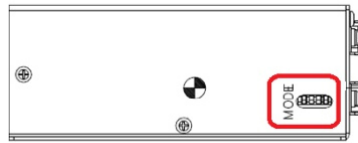

Verify that the Mode control Switch is set in Default configuration below:



Figure 5 - NAT Tie Lines

2. RX Level knob adjustment:

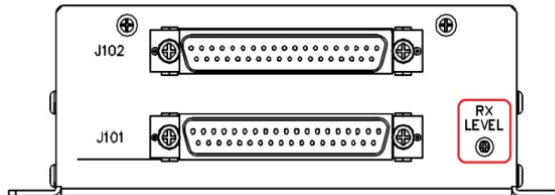

Move completely counter clockwise the RX-LEVEL knob (minimum setting), then rotate the RX LEVEL knob $\frac{3}{4}$ turn clockwise.

3. Headset Volume and Sensitivity Adjustment. □

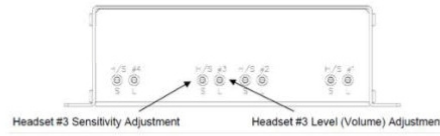

For each headset (see below table), rotate the Trimpots L and S fully counter-clockwise.

Table 14-1– Customization Headsets

NAT ADAPTER	NAT TRIMPOT	REF DES → CREW	AV900 REF. DES.
A670	H/S 1	HT128 → CREW 2	A189
	H/S 2	HT129 → CREW 3	

4. Set the signal generator to provide □

- Output: sine curve
- Frequency: 1KHz
- Amplitude: 350 mVrms.

Connect the Oscilloscope directly to the output of signal generator (50ohm 2Vp-p output) and check the value set and, if necessary, adjust Amplitude and offset.

If the multimeter is used, connect it to the output (50ohm 2Vp-p output) and adjust the offset until $V(\text{cont})=0V$ and the Amplitude until $V(\text{Alt}) \sim 350 \text{ mV}$

5. On the 4th AV900 station set the following audio and VOX level: □

- CAB: 60
- HDPH: 70
- VOX: 20

On the 4th AV900 station disengage VOX pushbutton

6. Starting from CREW 1 (ref. to Table above) and connecting all others headsets to ICS Loop, □ connect as follows:

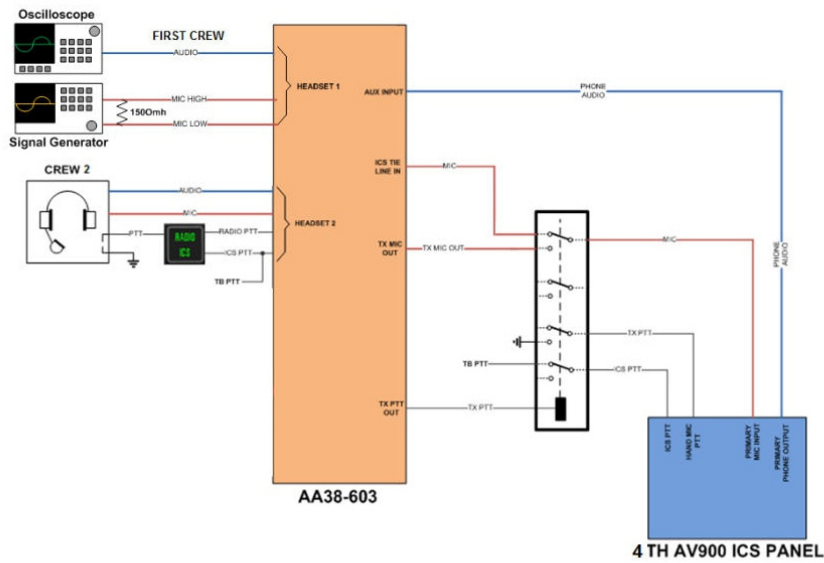

Connect the Oscilloscope to the Phone output.

Connect the signal generator to the MIC input (see picture above)

If multimeter is used, connect the testing cable as in following figure:

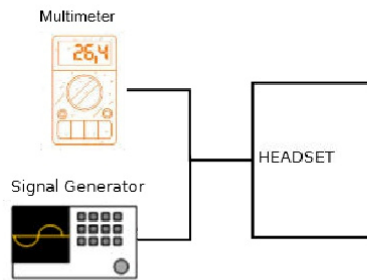

NOTE: Using a T adaptor for the connection to the signal generator, install a 50Ω termination cap

on the adaptor (see figure below as reference)



7. Move clockwise (or counter-clockwise) the relevant L Trimpot until the measured value (from oscilloscope or multimeter) is 350 mVrms
8. Move clockwise (or counter-clockwise) the relevant S Trimpot until the measured value (from oscilloscope or multimeter) passes from 350 mVrms to a value close to zero (typically < 10 mVrms)
9. Repeat the points 6, 7, 8 on the other headsets.
10. Connect a David Clark Headset to one headset on pilot or copilot.

Regulate RX LEVEL up to make the headset audio clear and strong when the pilot/co-pilot speaks.

Note: an RX LEVEL too low (knob CCW) causes an audio too low during cockpit communication, an RX LEVEL too high (knob CW) causes a crackling in the audio during cockpit communication

14.5.2 CABIN ICS FUNCTIONS

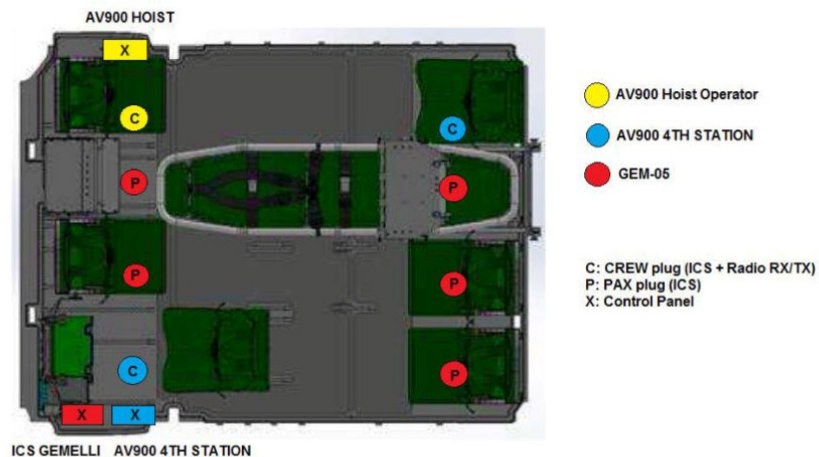

(Only for ref)

14.5.2.1 FOURTH AV900 ICS FUNCTIONS

1. Connect David Clark Headsets; model H10-13, to the 4th Cabin AV900 positions: 2nd and 3th crew.
2. Verify that all the Cabin AV900 Audio Panels are not set to emergency status (“BKUP” control knob potentiometer to the latched-in position).
3. On the Cabin AV900 Audio Panels set mute all the audio COM & NAV output disengaging the relevant pushbuttons. Verify all the pushbutton’s lights are turned OFF.
4. On the Cabin AV900 Audio Panels press “CAB” pushbutton to select the cabin ICS system setting. Rotate the knob on the cabin audio panels. Set it to a mid-range value.
5. On the Cabin AV900 Audio Panels press the “VOX” pushbutton to select the MIC settings. In order to obtain the best setting for the ambient noise rotate the knob fully ccw, then slowly rotate it cw until the intercom just becomes ‘quiet’.
6. On Cabin Audio Panels press the “HDPH” pushbutton to select the master volume setting. Set the master volume to a mid-range value.
7. On the Cockpit Audio Panels press the “CAB” pushbutton to join the cabin and cockpit ICS loop.
8. Set all the ICS/RADIO cabin switch to ICS position.
9. Talking into all the headsets positions: 2nd and 3rd Crew connected to 4th Cabin AV900, verify that:
 - Sidetone is of adequate level and discernible and that the transmission is clearly heard through Pilot’s and Copilot’s headsets and through all the other Cabin Audio headphones (including the ones connected to ICS GEMELLI kit).
 - On the 4th Cabin AV900 select “VOX” pushbutton and, while talking in the headsets, move the SET Knob to change the Hot Mic. Level from level 0 to level 99. Verify for each headset that Microphone sensibility changes from a soft (softest level: 0, mic. easy to be opened) to a hard hot mic. mode (hardest level: 99, mic. hard to be opened). Set VOX back to the previous level selected.
 - On the 4th AV900 disable the hot mic function pressing the relevant button (VOX led on 4th Cabin AV900 set to OFF). Verify Pilot and Copilot can’t hear 2nd and 3rd crew voices
 - With the 4th AV900 VOX pushbutton still disable pressing the 2nd and 3rd crew PTT buttons and verify that now the headsets microphones are now opened and the voice is clearly heard in the Pilot, Copilot. Enable VOX pushbutton.
10. Pull out the 4th AV900 circuit breaker and verify that “4 Audio Fail” should appear in CAS message windows.
11. Pull in the 4th AV900 circuit breaker and, on the 4th AV900 audio panel, unlatch “BKUP” knob and set it to a fully CW position.
12. Talk into 2nd and 3rd crew headsets positions and verify the presence of the sidetone and that the voice is clearly heard in the Pilot’s and Copilot’s headset.
13. Push in the 4th AV900 audio panel “BKUP” knob.

14.5.3 RADIO COMMUNICATION TEST

14.5.3.1 FOURTH AV900 RADIO COMMUNICATION TEST

1. Set a test frequency on one mission Radio installed. On control panel push in AUD and MIC button of the relevant COM transceiver button (COM3, COM4 or COM5).
2. Select on an external radio the same frequency or channel selected for helicopter radio.
3. Verify that RADIO/ICS buttons for 2nd and 3rd cabin crew operators are selected on RADIO position. If ICS position is selected push the buttons in order to toggle to RADIO setting.
4. Transmit with the external radio and verify that the audio is clearly heard through all the headsets connected to the 4th AV900 control panel (2nd and 3rd crew).
5. From 2nd cabin crew operator, the first one connected to 4th AV900, press PTT button on the headset extension and verify the satisfactory transmission to the external radio.
6. From 3rd cabin crew operator, the second one connected to 4th AV900, press PTT button on the headset extension and verify the satisfactory transmission to the external radio.
7. On 4th AV900 Audio Panel push in the PA MIC and AUD pushbuttons.
8. From 3rd cabin crew headset perform a transmission (press PTT button on the headset extension) and verify satisfactory transmission of audio signal over the internal PA speakers
9. From 2nd cabin Crew headset perform a transmission (press PTT button on the headset extension) and verify that 2nd Crew position has priority above 3rd Crew position
10. Set back at the ICS position both RADIO/ICS switches for both 2nd and 3rd crew position.

14.5.4 EMERGENCY CALL TEST

1. On both cockpit Pilot's and Copilot's AV900 audio panels disable the CAB buttons.
2. On 4th AV900 audio panel push and hold the Emergency call button (yellow CALL button).
3. Talking into all the headsets positions: 2nd and 3rd crew headsets and verify that the audio into Pilot's and Copilot's headsets is clearly heard and that the side tone is of adequate level and discernible.
4. During the time the Emergency CALL button is held down on cabin AV900, verify that on cockpit AV900 that receives the emergency CALL appears the "EM CALL" annunciation on the display and that the CALL button is lighted up.
5. Release the yellow CALL button on Cabin AV900 and verify that the Emergency Call ends: the audio is no longer audible through the cockpit audio panels.

14.6 TESTS RESULT

Table 14-2 3G2350P04911 HELICOPTERS AUDIO CUSTOMIZATION ATP (DAW UPGRADE)

139G2350D018 AW139 – 3G2350P04911 HELICOPTERS AUDIO CUSTOMIZATION Acceptance Test Procedure				
<i>REF.</i>	<i>DESCRIPTION</i>	<i>OPERATOR</i>	<i>DATE</i>	<i>REMARKS</i>
14.1	TEST EQUIPMENT			
14.2	TEST PREREQUISITES AND SAFETY PROVISION			
14.3	ELECTRICAL SETTINGS			
14.4.1	INSTALLATION AND POWER SUPPLY CHECKS			
14.5.1	AA38-603 ADJUSTMENT			
14.5.2	CABIN ICS FUNCTIONS			
14.5.3	RADIO COMMUNICATION TEST			
14.5.4	EMERGENCY CALL TEST			
Engineering dpt signature (if required):				
Quality dpt approval:				

ANNEX B

CABIN AV900 ACCEPTANCE TEST PROCEDURE

1. SCOPE

This document defines the Acceptance Test Procedure to be applied to all the Cabin AV900s, except for the ICS Hoist Operator System (for which the ref.[1]) to be applied), installed as Kits on the AW139 Helicopter. The ATP consists of tests to verify the integrity of the electrical interfaces for the AV900 Cabin ICS to the Primus EPIC™ avionics system.

The test procedures have been compiled on the basis of the interface requirements for each system and on the basis of the assumption that the tests are performed by individuals having general knowledge of the Primus EPIC™ avionics system, the test equipment required for the tests (as specified herein), and the AW139 helicopter systems.

1.1 APPLICABILITY

This document is applicable to all the Agusta AW139 production helicopters where two or more ICS AV900 audio panels are installed in the cabin. This document is applicable if PRIMUS EPIC® S/W rel. 4.8 or successive is installed.

2. GENERAL

2.3 ACRONIMS AND ABBREVIATIONS

The following acronyms and abbreviations are utilized throughout the document:

Table Error! Use the Home tab to apply Titolo 1 to the text that you want to appear here.. 1 Acronyms and Abbreviations

Acronym / Abbreviation	Description / Definition
ADC	Air Data Computer
ADF	Automatic Direction Finding
ADM	Air Data Module
ADS	Air Data System
AHRS	Attitude and Heading Reference System
AHRU	Attitude and Heading Reference Unit
AM	Amplitude Modulation
ASCB	Avionic Standard Communication Bus
AFCS	Automatic flight Control System
ASCB-D	Avionics Standard Communications Bus D version
CAS	Crew Alerting System
CB	Circuit Breaker
CCD	Cursor Control Device
CMC	Central Maintenance Computer
Comm	Communication radio
CPLT	Copilot
CSIO	Custom I/O Module in MAU
CTCSS	Continuous Coded Squelch System - sub-audible tone
DAB	Digital Audio Bus
DFTS	Digital Flight Test Suite

Acronym / Abbreviation	Description / Definition
DH	Decision Height
DME	Distance Measuring Equipment
DU	Display Unit
EDS	Electronic Display System
FDR	Flight Data Recorder
FM	Frequency Modulation
FMS	Flight Management System
FPL	Flight Plan
GPS	Global Positioning System
ICS	Inter Communication System
IM	Inner Marker
Kts	Nautical Miles per Hour (Knots)
LAN	Local Area Network
L-ASCB	Left Side Avionics Standard Communication Bus
LED	Light Emitting Diode
MAU	Modular Avionics Unit
MCDU	Multifunction Control Display Unit
MFD	Multifunction Display
MM	Middle Marker
MRC	Modular Radio Cabinet
NAV	Navigation radio
NIC	Network Interface Controller
NIM	Network Interface Module
OAT	Outside Air Temperature
OBS	Omni-Bearing Selector
OM	Outer Marker
PBA	Push-button Annunciator
PFD	Primary Flight Display
PLT	Pilot
POST	Power-on-Self-Test
PTT	Push-to-talk
RA	Radar Altimeter
RAD ALT	Radar Altimeter
R-ASCB	Right Side Avionics Standard Communication Bus
RI	Remote Instrument (Controller)
RSB	Radio System Bus
S/W	Software
TBD	To be defined
TIU	Terminal Interface Unit
V/UHF	Very and Ultra High Frequency
XPDR	Transponder
WX Radar	Weather Radar

3. SYSTEM DESCRIPTION

The Cabin AV900 audio panels consists of Honeywell audio panels, like the cockpit mounted ones, installed in the Cabin for use by a generic Crew Operator.

Each audio panel provides Radio and Intercommunication functions with a protocol to manage the Call between cockpit and cabin and it's able to drive two headsets where only one can talk in the radios.

In addition, for the Block3 audio panels (p/n: 7511900-99001 and 7511900-99201), the Cabin AV900s provide an Emergency all Call feature to talk directly with the cockpit without waiting the pilots acknowledge.

3.1 ARCHITECTURE and INTERFACES

When a new cabin AV900 Audio panel is installed, the Primus Epic APM Option File needs to be properly configured to enable the Primus Epic system to manage the new audio panel (Refer to [F]) for the option file loading procedure).

Each Cabin AV900 audio panel is interfaced to the Digital MIC and Phone bus as the cockpit ones. In addition, to support the communication even if one of the cabin audio panels fails, the Analog Emergency busses are connected to the maintenance MIC and Phone I/O ports of the preceding ones as indicated in the following block diagram (see Figure 1). The shaded box representing the DVAR kit installed on AW139 is an equipment that could interface to the CABIN AV900 system.

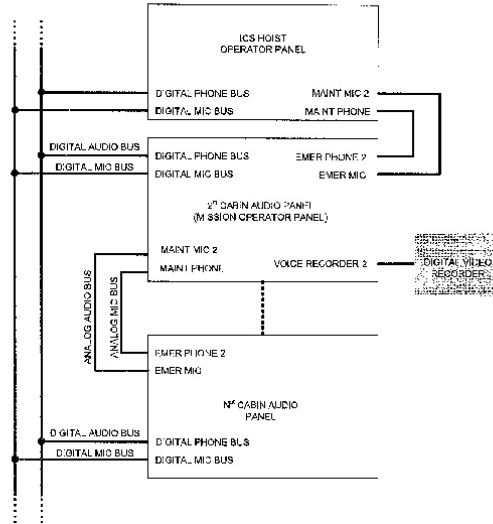

Figure 1 - CABIN AV900 Block Diagram

Each Cabin AV900 can drive two headsets. The headset connected to the primary Audio and MIC busses can talk through the radios and the relevant PTT button is connected either to the RADIO or to the Intercom PTT according to ICS/RADIO switch position placed in the cabin close to the audio panel.

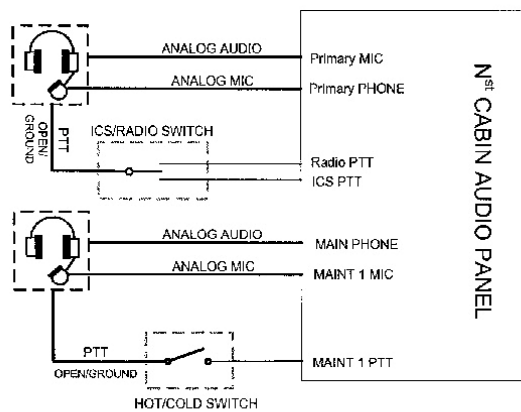

Figure 2 - Headsets to Audio Panel Connection

The headset connected to the maintenance Phone and MIC busses can talk only through the interphone channel. In addition by a selection on an external HOT/COLD switch the system provides to the operator the feature to talk either in Hot Mike or in Cold mike condition.

3.2 SYSTEM COMPONENTS

According to the particular helicopter configuration the part number of the AV900 audio panels that can be installed in the cabin are listed in Table **Error! Use the Home tab to apply Titolo 1 to the text that you want to appear here..1**.

Table Error! Use the Home tab to apply Titolo 1 to the text that you want to appear here..1 - CABIN AV900 System Components

DESCRIPTION	MODEL	PART NUMBER	SUPPLIER	NOTES
AV900 Block 2 Audio panel (non NVG)	AV-900	7511900-98602	Honeywell	
AV900 Block 2 Audio panel (NVG)	AV-900	7511900-98801	Honeywell	
AV900 Block 3 Audio panel (non NVG)	AV-900	7511900-99001	Honeywell	Used only if the phase 4 SW rel. is installed
AV900 Block 3 Audio panel (NVG)	AV-900	7511900-99201	Honeywell	Used only if the phase 4 SW rel. is installed

NOTE: To allow a properly operation of the AW139 ICS system all the cabin AV900 audio panels must have the same part number.

4. SYSTEM TESTS

4.1 TEST PREREQUISITES and SAFETY PROVISION

1. Visually verify the proper installation of all the cabin AV900, except for the ICS Hoist op. that has been previously checked in ref.[I]). Check the correct mechanical installation and fixing; Check the Electrical wires installation; Check that all the connectors are properly plugged and fastened. Use the drawing in ref. [A), B), C), D)] as reference documents.
2. With the helicopter powered off, verify the proper bonding of each Audio Control Panel. The maximum acceptable bonding value, referred to the helicopter ground, can be 5mΩ maximum.
3. AW139 - AVIONICS ACCEPTANCE TEST PROCEDURE, ref. [K]), successfully completed (at least for the Electronic Display System, the Multi-Purpose Control Display Unit, ICS and the VHF Communication System sections).
4. AW139 – ICS HOIST OPERATOR ATP, ref. [I]), successfully completed;
5. The wiring harness installation must be checked by DIT-MCO.
6. Detent pin shall be installed on wiper screen arm.
7. Verify that the Primus Epic S/W 4.8 or following release is installed.
8. Verify that the APM option file installed enables all the Cabin AV900 Audio panels. (For example, if there are two AV900 panels in the cabin the option file with selections “audioPan3installed” and “audioPan4installed” enabled should be installed). Refer to the procedure described in the document: “AW139 – PRIMUS EPIC® Software Installation Procedure: 139G4600M001” ref.[F]).
9. During the test with helicopter electrically powered, the “IGN #1/2” and “START #1/2” breakers shall be pulled out.

4.2 TEST EQUIPMENT

The following equipment is required for the test procedure:

Table 4.1 ICS Test Equipment

DEVICE	P/N	S/N	NOTE
(1) DC External Power Bench (28VDC).			

(2) Three Headset kit for Pilot, Copilot and Hoist operators plus two headset for each AV900 installed in the cabin.			
--	--	--	--

4.3 ELECTRICAL SETTINGS

1. Verify that all the Electrical Power Distribution System Circuit Breakers are pushed in except for Circuit Breakers for the Cabin AV900 Audio Panels refer to the drawing in ref. [A), B), C), D)];
2. Verify that all the Avionic Devices Circuit Breakers are pushed in;
3. The helicopter external power port shall be connected to the External Power Bench set to 28 VDC output. Power up the External Power Bench before starting with the test procedure.

4.4 CABIN AV900 TEST PROCEDURE

4.4.1 AV900 pre-setting

Before proceeding with the ICS functional tests, apply the following presetting to any of the AV-900 audio panels installed in the Cabin.

4.4.1.1 AV900 pre-setting

1. Before proceeding with the AV900 pre-setting take care all the audio panels installed on the aircraft are powered up and the aircraft is on ground (AOG logic is defined as: A/S < 40kts, Radalt < 15 ft, V/S < 0 ft/min, Collective < 20%, and Rotor < 80%).
2. Depress and hold INPH (PLT for Block 3), HDPH, and COM1 MIC buttons simultaneously until the display window reads "CONFIG". This should take about five seconds.
3. Depress the HDPH button to scroll through the User Configuration Data. The INPH (PLT for Block 3) button can be used to scroll back.
4. To modify a setting, turn the VOL Knob until the desired value is displayed. The displayed value should be prefixed by an asterisk. For example, if the "Warning Audio Volume in Headphones" is modified, the display would read: "WPHN:*55".
5. To store a setting, depress the COM1 MIC button once (the asterisk drops).
6. Apply step 3, 4 and 5 to adjust the values listed in the Table 4.2.

NOTE: Apply the proper settings column regards to the AV900 installed part numbers ref. Table Error! Use the Home tab to apply Titolo 1 to the text that you

want to appear here..1.

7. When all changes have been made, depress and hold the INPH (PLT for Block 3), HDPH, and COM1 MIC buttons simultaneously until the Display Window reads: "SAVE: Y".
8. Depress and hold the INPH (PLT for Block 3), HDPH, and COM1 MIC buttons simultaneously until the Display Window reads: "SAVING".
9. After a short delay, the Display Window will change to read: "BCASTING". The Display Windows on the other AV-900's will read: "DATASYNC".
10. After another short delay, the AV-900 will return to normal operation.

Table 4.2 - AV900 Configuration Settings

DESCRIPTION	NOMENCLATURE	Block 2 Setting	Block 3 Setting
Warning Channel #1 Gain	WRN1	50	50
Warning Channel #2 Gain	WRN2	50	50
Warning Channel #3 Gain	WRN3	50	50
Warning Channel #4 Gain	WRN4	50	50
Warning Channel #5 Gain	WRN5	50	50
Master Warning Gain applied to all warning channels	MWRN	84	55
Warning Audio Volume in Headphones	WPHN	07	55
Warning Audio Volume in Speakers	WSPK	0	0
The preset level for headphone squelch	PHSQ	0	0
The preset level for microphone squelch	MCSQ	0	0
The preset level for Maintenance Microphone squelch	MTSQ	0	0
Minimum gain all audio can be set to.	MNGN	10	10
The volume applied when Marker mute is muted	MKMT	30	30
Internal or Hybrid PA amplifier gain.	PAGN	60	60

Internal PA Enable OFF/ON	INPA	OFF	ON
Hybrid PA digital audio volume level	HYP A	60	60
Minimum volume level the speakers can be set to	SPMN	30	0
Minimum volume level the headphones can be set to	HPMN	30	30
Mask Microphone volume level	MKGN	83	40
Mask Microphone High or Low Gain Setting Switch	MKLV	LO	LO
Hand microphone volume level	HDGN	83	40
Hand Microphone High or Low Gain Setting Switch	HDLV	LO	LO
Boom microphone volume level	BMGN	83	40
Boom Microphone High or Low Gain Setting Switch	BMLV	LO	LO
CA-900 Microphone volume level	CAGN	83	50
CA-900 Microphone High or Low Gain Setting Switch	CALV	LO	HI
CA-900 Microphone digital audio volume level	CAVL	50	83
Right Speaker Warning Gain Zero	ZERO	08	10
Maintenance microphone # 1 volume level	M1GN	83	70
Maint 1 Microphone High or Low Gain Setting Switch	M1LV	LO	LO
Maintenance microphone # 2 volume level	M2GN	83	70
Maint 2 Microphone High or Low Gain Setting Switch	M2LV	LO	LO
Maintenance Intercom headphone volume level	MPLV	81	70
Speaker sidetone volume level	SST	60	60
Volume Level of APU Fire Bell	FBEL	60	00

Headphone Chime Volume Level	CHPN	50	50
Speaker Chime Volume Level	CHSP	50	50

NOTE: The values considered in the pre-setting procedure constitute a subset of the complete one available on AV-900 audio panels. During the ATP, skip the values that must not be adjusted.

4.4.2 ICS FUNCTIONS

1. Connect the headsets to the Pilot's, Copilot's and Cabin headset jacks.
2. Verify PTT switches for all Installed Cabin AV900s are on ICS position.
3. Verify the Pilot, Copilot and Cabin AV900 Audio Panels are not set to emergency status ("BKUP" control knob potentiometer to the latched-in position).
4. On the Pilot, Copilot and Cabin AV900 Audio Panels set mute all the audio COM & NAV outputs disengaging the relevant pushbuttons.
5. Verify all the pushbutton's lights are turned OFF.
6. On the Pilot, Copilot Audio Panels press "INPH" ("PLT" for Block3 audio panels ref. to Table **Error! Use the Home tab to apply Titolo 1 to the text that you want to appear here..1**) pushbutton to select the cockpit ICS system setting. Verify the "INPH" ("PLT" for Block3 audio panels) pushbutton illuminates and the relevant heading and volume level appear on the Audio Panels Display.
7. Rotate the SET knob on the cockpit audio panels and verify the volume indication on the display tracks it. Set it to a mid-range value.
8. On the Pilot, Copilot Audio Panels press and hold "CAB" pushbutton to select the Cabin ICS system setting. Verify the "CAB" relevant heading and volume level appear on the Audio Panels Display.
9. Rotate the SET knob on the cockpit audio panels and verify the volume indication on the display tracks it. Set it to a mid-range value.
10. On the Cabin AV900 Audio Panels press "INPH" ("CAB" for Block3 audio panels ref. to Table **Error! Use the Home tab to apply Titolo 1 to the text that you want to appear here..1**) pushbutton to select the cabin ICS system setting. Verify the "INPH" ("CAB" for Block3 audio panels) pushbutton illuminates and the relevant heading and volume level appear on the Audio Panels Display.
11. Rotate the SET knob on the Cabin audio panels and verify the volume indication on the display tracks it. Set it to a mid-range value.
12. On the Pilot, Copilot and Cabin AV900 Audio Panels press the "VOX" pushbutton to select the MIC settings. Verify the "VOX" pushbutton light is illuminated steady and the relevant heading and level appear on the Audio Panel display.
13. By the SET knob set the squelch VOX level to a low-range value (between 10-20).
Note: adjust the VOX value in order to avoid that the Microphone is open by the external noise but only by operator voices.
14. On Pilot, Copilot and Cabin Audio Panels press the "HDPH" pushbutton to select the master volume setting. Verify the "HDPH" pushbutton illuminates and the relevant heading and level appear on the Audio Panel display.
15. By SET Knob set the master volume to a mid-range value.
16. Set the Cabin primary Operators switches to ICS selection and the HOT/COLD selectors, for secondary cabin Operators if installed (ref. to the "helicopter under test" applicable drawings), to HOT position.
51. On the Mission Operator Audio Panel press the "PA" pushbutton; verify that both the "mic PA" led and "aud PA" led illuminate and the relevant heading and volume appear on the display.

52. By the "SET" knob, set the volume to a mid-range value to adjust the sidetone volume.
53. For **Block3** audio panels (see Table **Error! Use the Home tab to apply Titolo 1 to the text that you want to appear here..1**).
- On the Pilot's and Copilot's Audio Panels press "CAB" pushbutton to deselect the Cabin ICS system. On the Mission Operator Audio Panel press PLT to call the cockpit ICS loop. Verify that:
- The CAB button on the cockpit audio panels flashes.
 - The cockpit audio panels will sound a chime to alert the pilots to the call from the cabin.
- On the Pilot Audio Panel press the CAB button and verify that:
- The CAB button light remains illuminated.
 - The CAB buttons on the other cockpit audio panels stop flashing and are turned off.
 - The pilot is able to talk to the personnel in the cabin using the Cabin Intercom Channel.
54. Repeat the test form point 17 to 53 for all the other Cabin AV900.

4.4.3 RADIO FUNCTIONS

The following tests concern only the operator connected on the Primary Audio and MIC bus (primary Operator plug) of each Cabin AV900 installed in the cabin who is able to communicate through the Radio.

1. Switch the PTT selector for the Mission Operator to RADIO position.
2. Tune VHF1 (VHF2) Radio to a known local ground station frequency (i.e.: VERGIATE control tower 119.775 MHz).
3. On the Mission Operator Audio Panel press the COM1 (VHF1) Aud enabling button.
4. Verify that the green Light is illuminated.
5. Set the COM1 (VHF1) source volume to a mid-range value by the "SET" knob. Enable "HDPH", "INPH" ("CAB" for Block3 audio panels ref. Table **Error! Use the Home tab to apply Titolo 1 to the text that you want to appear here..1**) and "VOX" functions and set their volumes to a middle range level.
6. Verify satisfactory reception of transmission from the local ground station.
7. On the Mission Operator Audio Panel press the COM1 (VHF1) Mic enabling button. Verify there is no response (*) from the audio panel (button disabled).
8. Press the Mission Operator PTT.
9. Verify Mission Operator Microphone is disabled (no sidetone).
10. Repeat point 2 to 9 for COM2 (VHF2).
11. Tune NAV1 to a known local VOR station.
12. On the Mission Operator Audio Panel enable NAV1 audio input and set it to middle range volume. Verify a tone is audible in Mission Operator headset and audio tone volume is adjustable by the relevant commands on the audio control panel. Disable NAV1.
13. Tune NAV2 to a known local VOR station.
14. On the Mission Operator Audio Panel enable NAV2 audio input and set it to middle range volume. Verify a tone is audible in Mission Operator headset and audio tone volume is adjustable by the relevant commands on the audio control panel. Disable NAV2.
15. Tune DME2 to a known local DME station.
16. On the Mission Operator Audio Panel enable DME2 audio input and set it to middle range volume. Verify a tone is audible in Mission Operator headset and audio tone volume is adjustable by the relevant commands on the audio control panel. Disable DME2.
17. Tune ADF2 to a known ADF station.
18. On the Mission Operator Audio Panel enable ADF2 audio input and set it to middle range volume. Verify a transmission is audible in Mission Operator headset and audio volume is adjustable by the relevant commands on the audio control panel. Disable ADF2.
19. Repeat the test form point 1 to 18 for all the other Cabin AV900.

(*) Block 3 audio panels (-99001 and -99201) provide the feature to communicate on the VHF1 and VHF2 radios from the cabin if the option file with "cabinCOM1TxEnable" and "cabinCOM2TxEnable" enabled is installed.

4.4.4 Emergency All Call Function (Block3)

The following tests concern only the Block 3 AV900 audio panels (refer to Table Error! Use the Home tab to apply Titolo 1 to the text that you want to appear here..1).

With Block3 audio panel a yellow CALL button has been added so that any crew member can immediately make an emergency intercom call. The AV-900 CALL button will immediately connect the cabin to the pilots during the time the button is held down with no acknowledgement required by the pilots or any other crewmember.

1. If illuminated push in all the CAB button on the cockpit AV900 audio panels to disconnect cockpit and cabin.
2. Depress and Hold the yellow "CALL" button on the Mission audio panel.
3. During the time the "CALL" button is depressed talk into the Primary Mission headset microphone.
4. Verify that the display of the Mission AV-900 indicates: "CALL TX" and the Primary Mission Operator voice is heard into the Pilot's, Copilot's Headsets and into the all the other Cabin Audio Panels.
5. Verify that on the AV900s that receives the emergency CALL appears the "EM CALL" annunciator on the display and the ALL CALL buttons light up indicating that an incoming ALL CALL message is in progress.
6. Release the "CALL" button and verify that the Emergency Call ends, and the AV900 audio panels revert back to the settings prior to Emergency Call.
7. Talk in the Mission audio panel and verify that the audio is no longer audible through the pilot's and copilot's audio panels.
8. Repeat the tests, from point 1 to 7 for all the other Cabin AV900.

4.5 TEST RESULTS

Table Error! Use the Home tab to apply Titolo 1 to the text that you want to appear here..3 ICS Hoist Operator Acceptance Test Procedure

ICS Hoist Operator Acceptance Test Procedure				
REF.	DESCRIPTION	OPERATOR	DATE	REMARKS
4.1	TEST PREREQUISITES and SAFETY PROVISION			
4.2	TEST EQUIPMENT			
4.3	ELECTRICAL SETTINGS			
4.4.1	AV900 pre-setting			
4.4.2	ICS FUNCTIONS			
4.4.3	RADIO FUNCTIONS			
4.4.4	Emergency All Call Function (Block3)			
Engineering dpt signature (if required):				
Quality dpt approval:				

ANNEX C

AW139 RESCUE HOIST SYSTEM BREEZE 90 METERS ATP

2.4.7 HOIST ICS COMMUNICATION TEST FUNCTION

PHASE	OPERATIONS	RESULTS
1.	<ul style="list-style-type: none"> -Push IN CB59, CB62. -Push IN CB113, CB44, CB72 (ICS system). -On the HOIST cont pnl, switch ON "HOIST PWR". -From the HOIST Operator, connect an Headset to the ICS system. -Establish a two way communication between the HOIST Operator and the Pilot or Copilot, using the HOIST control pendant trigger grip 	-Check the two way communication is functioning.
2.	<ul style="list-style-type: none"> -On the HOIST Cont pnl, switch OFF "HOIST PWR" -Trip CB59, CB62. 	

