



Doc. No.	GAM047/ICA
Date	19/03/2021
Revision	0

# LEONARDO S.p.A AW139 INSTRUCTIONS FOR CONTINUED AIRWORTHINESS



## INSTALLATION OF PLACARDS AND MARKINGS

### IMPORTANT NOTE

This technical content of this document is approved under the authority of the DOA Approval No. DOA/2020/01.

The effectivity of the document at the latest revision is specified on the List of Effective Pages.

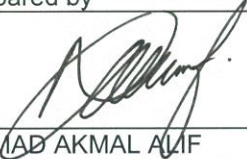
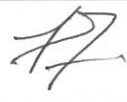
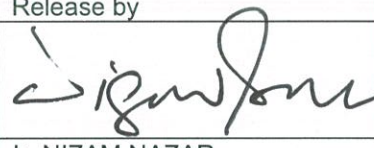
### Approval Signature

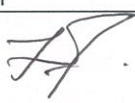
Prepared by	Verified & Approved by	Release by
 AHMAD AKMAL ALIF Show Compliance Engineer (Cabin Interior) 19/03/2021	 NUR FARHANA OTHMAN Compliance Verification Engineer (Cabin Interior) 19/03/2021	 Ir. NIZAM NAZAR Approved Signatory 19/03/2021
 AHMAD AKMAL ALIF Show Compliance Engineer (Structure) 19/03/2021	 NUR FARHANA OTHMAN Compliance Verification Engineer (Structure) 19/03/2021	

 <b>Galaxy Aerospace</b> <small>maintenance . repair . overhaul</small> <b>INSTRUCTIONS FOR CONTINUED AIRWORTHINESS</b>	<b>INSTALLATION OF PLACARDS AND MARKINGS ON LEONARDO S.p.A AW139</b>	
	Doc. No.	GAM047/ICA
	Date	19/03/2021
	Revision	0

## TABLE OF CONTENTS

<u>Description</u>	<u>Page</u>
LOG OF REVISIONS .....	3
INTRODUCTION.....	5
1    EFFECTIVITY .....	5
2    SCOPE .....	5
3    PURPOSE.....	5
4    PRECAUTIONS .....	5
5    DISTRIBUTION OF ICA.....	5
SECTION A AIRWORTHINESS LIMITATIONS .....	6
1    AIRWORTHINESS LIMITATIONS .....	6
SECTION B INSPECTION SCHEDULE AND MAINTENANCE CHECKS .....	7
1    INSPECTION REQUIREMENTS .....	7
2    COMPONENT OVERHAUL SCHEDULE .....	7
SECTION C MAINTENANCE PROCEDURES .....	8
1    DESCRIPTION AND MAINTENANCE DATA .....	8
1.1. <i>Weight &amp; Moment Arm</i> .....	8
1.2. <i>Placards and Markings</i> .....	8
2    MAINTENANCE INSTRUCTIONS.....	8
2.1 <i>Inspections (Exterior and Interior Markings)</i> .....	8
2.2 <i>Exterior Placard Replacement</i> .....	9
2.3 <i>Exterior Placard Cleaning</i> .....	10
2.4 <i>Exterior Placard – Repairing Damaged Areas</i> .....	11
2.5 <i>Interior Placard Replacement</i> .....	11
2.6 <i>Functional Test</i> .....	12
2.7 <i>Troubleshooting</i> .....	12
SECTION D WIRING DIAGRAM (NOT APPLICABLE).....	13
SECTION E ILLUSTRATED PARTS AND TOOLS CATALOGUE.....	14

This document is the property of GALAXY AEROSPACE (M) SDN. BHD. (1040262-D), no part of it shall be reproduced or transmitted to third parties without the express prior written authorization of GALAXY AEROSPACE (M) SDN. BHD. nor shall its contents be disclosed.



Doc. No.	GAM047/ICA
Date	19/03/2021
Revision	0

**LOG OF REVISIONS**

Rev.	Affected Page(s)	Date	Descriptions of Revision	Prepared by	Verified & Approved by	Released by
0	All	19/03/2021	Initial Issue	AAA	NFO	INN



**INSTRUCTIONS FOR CONTINUED  
AIRWORTHINESS**

**INSTALLATION OF PLACARDS AND  
MARKINGS ON LEONARDO S.p.A AW139**

Doc. No.	GAM047/ICA
Date	19/03/2021
Revision	0

**PAGE INTENTIONALLY LEFT BLANK**

 <b>INSTRUCTIONS FOR CONTINUED AIRWORTHINESS</b>	<b>INSTALLATION OF PLACARDS AND MARKINGS ON LEONARDO S.p.A AW139</b>	
	Doc. No.	GAM047/ICA
	Date	19/03/2021
	Revision	0

## INTRODUCTION

### 1 Effectivity

LEONARDO S.p.A AW139.

Registration	Serial Number
9M-PMA	31807
9M-PMB	31726
9M-PMC	31731
9M-PMD	31809
9M-PME	31855
9M-PMF	31913

### 2 Scope

This document identifies the Instructions for Continued Airworthiness for Placards and Markings. This includes maintenance programme in association to the installation.

### 3 Purpose

This manual allows the Operator of the aircraft to possess necessary information in ensuring the continued airworthiness of the aircraft, so long as it is installed with this system as per JAR 29.1529.

### 4 Precautions

Use a cleaner designed for high-quality painted surfaces. The cleaner must be wet, non-abrasive, without strong solvents, and have a pH value between 3 and 11 (Neither strongly acidic nor strong alkaline).

### 5 Distribution of ICA

**Galaxy Aerospace (M) Sdn Bhd** will notify the Operator on any change or revision to this ICA. The Operator is responsible to notify the Design Holder on any change of ownership of the aircraft to address below:

**GALAXY AEROSPACE (M) SDN. BHD. (1040262-D)**  
 11-14, Helicopter Centre (MIAC),  
 Sultan Abdul Aziz Shah Airport,  
 47200 Subang,  
 Selangor Darul Ehsan, Malaysia.

Tel: +603-7734 7226

Email: [doa21@galaxyaerospace.my](mailto:doa21@galaxyaerospace.my)

This document is the property of GALAXY AEROSPACE (M) SDN. BHD. (1040262-D), no part of it shall be reproduced or transmitted to third parties without the express prior written authorization of GALAXY AEROSPACE (M) SDN. BHD. nor shall its contents be disclosed.

 <b>Galaxy Aerospace</b> <small>maintenance . repair . overhaul</small> <b>INSTRUCTIONS FOR CONTINUED AIRWORTHINESS</b>	<b>INSTALLATION OF PLACARDS AND MARKINGS ON LEONARDO S.p.A AW139</b>	
	Doc. No.	GAM047/ICA
	Date	19/03/2021
	Revision	0

## SECTION A

### AIRWORTHINESS LIMITATIONS

#### 1 Airworthiness Limitations

Airworthiness limitations are not applicable for this installation.



 <b>Galaxy Aerospace</b> <small>maintenance . repair . overhaul</small> <b>INSTRUCTIONS FOR CONTINUED AIRWORTHINESS</b>	<b>INSTALLATION OF PLACARDS AND MARKINGS ON LEONARDO S.p.A AW139</b>	
	Doc. No.	GAM047/ICA
	Date	19/03/2021
	Revision	0

## SECTION B

### INSPECTION SCHEDULE AND MAINTENANCE CHECKS

#### 1 Inspection Requirements

The aircraft's approved maintenance schedule shall be amended to include the maintenance actions called below:

NO.	ITEM	MAINTENANCE ACTION	INTERVAL
1.	All Placards and Markings	1. Inspect placards for illegibility, security and cleanliness. 2. Compulsory to change the placard when it has become illegible. 3. Contact Galaxy Aerospace (M) Sdn. Bhd for replacement.	Pre-Flight

#### 2 Component Overhaul Schedule

No component overhaul required for this minor modification design.

 <b>INSTRUCTIONS FOR CONTINUED AIRWORTHINESS</b>	<b>INSTALLATION OF PLACARDS AND MARKINGS ON LEONARDO S.p.A AW139</b>	
	Doc. No.	GAM047/ICA
	Date	19/03/2021
	Revision	0

## SECTION C MAINTENANCE PROCEDURES

### 1 Description and Maintenance Data

#### 1.1. Weight & Moment Arm

Not Applicable. The weight change is negligible to the overall aircraft weight.

#### 1.2. Placards and Markings

Refer to Section E – Illustrated Parts Catalogue for list of placards.

### 2 Maintenance Instructions

#### 2.1 Inspections (Exterior and Interior Markings)

##### A. References:

- i. Leonardo Helicopters S.p.A AW139 Maintenance Manual (MM), latest revision and issue.
- ii. 3M™ Instruction Bulletin 5.27, Dated May 2015, or latest revision.
- iii. 3M™ Product Bulletin 6900, Dated August 2015, or latest revision.

##### B. Specials Tools:

No special tools required.

##### C. Consumable Materials:

None

##### D. Job Set-up:

- i. Prepare the aircraft for the inspection.
- ii. Avoid carrying out inspection works if the aircraft is on jacks.
- iii. Identify locations for each inspection on the aircraft.
- iv. Implement suitable access means.



 <p><b>Galaxy Aerospace</b> maintenance . repair . overhaul</p> <p><b>INSTRUCTIONS FOR CONTINUED AIRWORTHINESS</b></p>	<b>INSTALLATION OF PLACARDS AND MARKINGS ON LEONARDO S.p.A AW139</b>	
	Doc. No.	GAM047/ICA
	Date	19/03/2021
	Revision	0

**E. Procedure:**

- i. Locate placards as per Section E.
- ii. Perform visual inspection as per maintenance action table of Section B Inspection Schedule and Maintenance Checks - 1 Inspection Requirements.
- iii. Check condition and security of placard.
- iv. Replace placards if damaged.

**F. Close up:**

- i. Check aircraft aspect and cleanliness.
- ii. Return aircraft to service and clean the work area.

**2.2 Exterior Placard Replacement**

**A. References:**

- i. Leonardo Helicopters S.p.A AW139 Maintenance Manual (MM), latest revision and issue.
- ii. 3M™ Instruction Bulletin 5.27, Dated May 2015, or latest revision.

**B. Specials Tools:**

- i. Refer 3M™ Instruction Bulletin 5.27, Dated May 2015, or latest revision.

**C. Consumable Materials:**

- i. Refer 3M™ Instruction Bulletin 5.27, Dated May 2015, or latest revision.

**D. Job Set-up:**

- i. Prepare the aircraft for the inspection.
- ii. Avoid carrying out inspection works if the aircraft is on jacks.
- iii. Identify locations for each inspection on the aircraft that need to be replaced.  
NOTE: Contact Galaxy Aerospace (M) Sdn. Bhd. for part replacement.
- iv. Implement suitable access means.

**E. Procedure:**

- i. Locate placards as per Section E.
- ii. Perform placard removal/installation according to 3M™ Instruction Bulletin 5.27, Dated May 2015 or latest revision.



**INSTRUCTIONS FOR CONTINUED  
 AIRWORTHINESS**

**INSTALLATION OF PLACARDS AND  
 MARKINGS ON LEONARDO S.p.A AW139**

Doc. No.	GAM047/ICA
Date	19/03/2021
Revision	0

**F. Close up:**

- i. Check aircraft aspect and cleanliness.
- ii. Return aircraft to service and clean the work area.

**2.3 Exterior Placard Cleaning**

**A. References:**

- i. Leonardo Helicopters S.p.A AW139 Maintenance Manual (MM), latest revision and issue.
- ii. 3M™ Instruction Bulletin 5.27, Dated May 2015, or latest revision.

**B. Specials Tools:**

- i. Refer 3M™ Instruction Bulletin 5.27, Dated May 2015, or latest revision.

**C. Consumable Materials:**

- i. Refer 3M™ Instruction Bulletin 5.27, Dated May 2015, or latest revision.

**D. Job Set-up:**

- i. Prepare the aircraft for the inspection.
- ii. Avoid carrying out inspection works if the aircraft is on jacks.
- iii. Identify locations for each inspection on the aircraft that need to be replaced.
- iv. Implement suitable access means.

**E. Procedure:**

- i. Locate placards as per Section E.
- ii. Perform placard removal/installation according to 3M™ Instruction Bulletin 5.27, Dated May 2015 or latest revision.

**F. Close up:**

- i. Check aircraft aspect and cleanliness.
- ii. Return aircraft to service and clean the work area.



 <p><b>Galaxy Aerospace</b> maintenance . repair . overhaul</p> <p><b>INSTRUCTIONS FOR CONTINUED AIRWORTHINESS</b></p>	<b>INSTALLATION OF PLACARDS AND MARKINGS ON LEONARDO S.p.A AW139</b>	
	Doc. No.	GAM047/ICA
	Date	19/03/2021
	Revision	0

## 2.4 Exterior Placard – Repairing Damaged Areas

### A. References:

- i. Leonardo Helicopters S.p.A AW139 Maintenance Manual (MM), latest revision and issue.
- ii. 3M™ Instruction Bulletin 5.27, Dated May 2015, or latest revision.

### B. Specials Tools:

- i. Refer 3M™ Instruction Bulletin 5.27, Dated May 2015, or latest revision.

### C. Consumable Materials:

- i. Refer 3M™ Instruction Bulletin 5.27, Dated May 2015, or latest revision.

### D. Job Set-up:

- i. Prepare the aircraft for the inspection.
- ii. Avoid carrying out inspection works if the aircraft is on jacks.
- iii. Identify locations for each inspection on the aircraft that need to be replaced.
- iv. Implement suitable access means.

### E. Procedure:

- iii. Locate placards as per Section E.
- iv. Perform placard removal/installation according to 3M™ Instruction Bulletin 5.27, Dated May 2015 or latest revision.

### F. Close up:

- iii. Check aircraft aspect and cleanliness.
- iv. Return aircraft to service and clean the work area.

## 2.5 Interior Placard Replacement

### A. References:

- i. Leonardo Helicopters S.p.A AW139 Maintenance Manual (MM), latest revision and issue.
- ii. 3M™ Adhesive Transfer Tape 468MP Revision December 2017, or latest revision.
- iii. 3M™ Product Bulletin 6900 Dated August 2015, or latest revision.



 <p><b>Galaxy Aerospace</b> maintenance . repair . overhaul</p> <p><b>INSTRUCTIONS FOR CONTINUED AIRWORTHINESS</b></p>	<b>INSTALLATION OF PLACARDS AND MARKINGS ON LEONARDO S.p.A AW139</b>	
	Doc. No.	GAM047/ICA
	Date	19/03/2021
	Revision	0

**B. Specials Tools:**

- i. Nil Special tool required.

**C. Consumable Materials:**

- i. Refer section E

**D. Job Set-up:**

- i. Prepare the aircraft for the inspection.
- ii. Avoid carrying out inspection works if the aircraft is on jacks.
- iii. Identify locations for each inspection on the aircraft that need to be replaced.  
NOTE: Contact Galaxy Aerospace (M) Sdn. Bhd. For part replacement.
- iv. Implement suitable access means.

**E. Placard Replacement:**

- i. Access to placard location which require replacement.
- ii. Perform old placard removal by peeling the placard. Start at corners and slowly peel off placard by hand or using a plastic wedge. Avoid damaging or removing paint or primer from surfaces. Remove decal entirely.
- iii. Clean the surface of the where the placard has been removed using isopropyl alcohol.
- iv. Install new placard. Attach placard and rub placard surface with finger, applying slight pressure.

**F. Close up:**

- i. Check aircraft aspect and cleanliness.
- ii. Return aircraft to service and clean the work area.

**2.6 Functional Test**

Not applicable.

**2.7 Troubleshooting**

Not applicable.

Doc. No.	GAM047/ICA
Date	19/03/2021
Revision	0

## SECTION D

### WIRING DIAGRAM (NOT APPLICABLE)

Doc. No.	GAM047/ICA
Date	19/03/2021
Revision	0

## SECTION E

### ILLUSTRATED PARTS AND TOOLS CATALOGUE



Doc. No.	GAM047/ICA
Date	19/03/2021
Revision	0

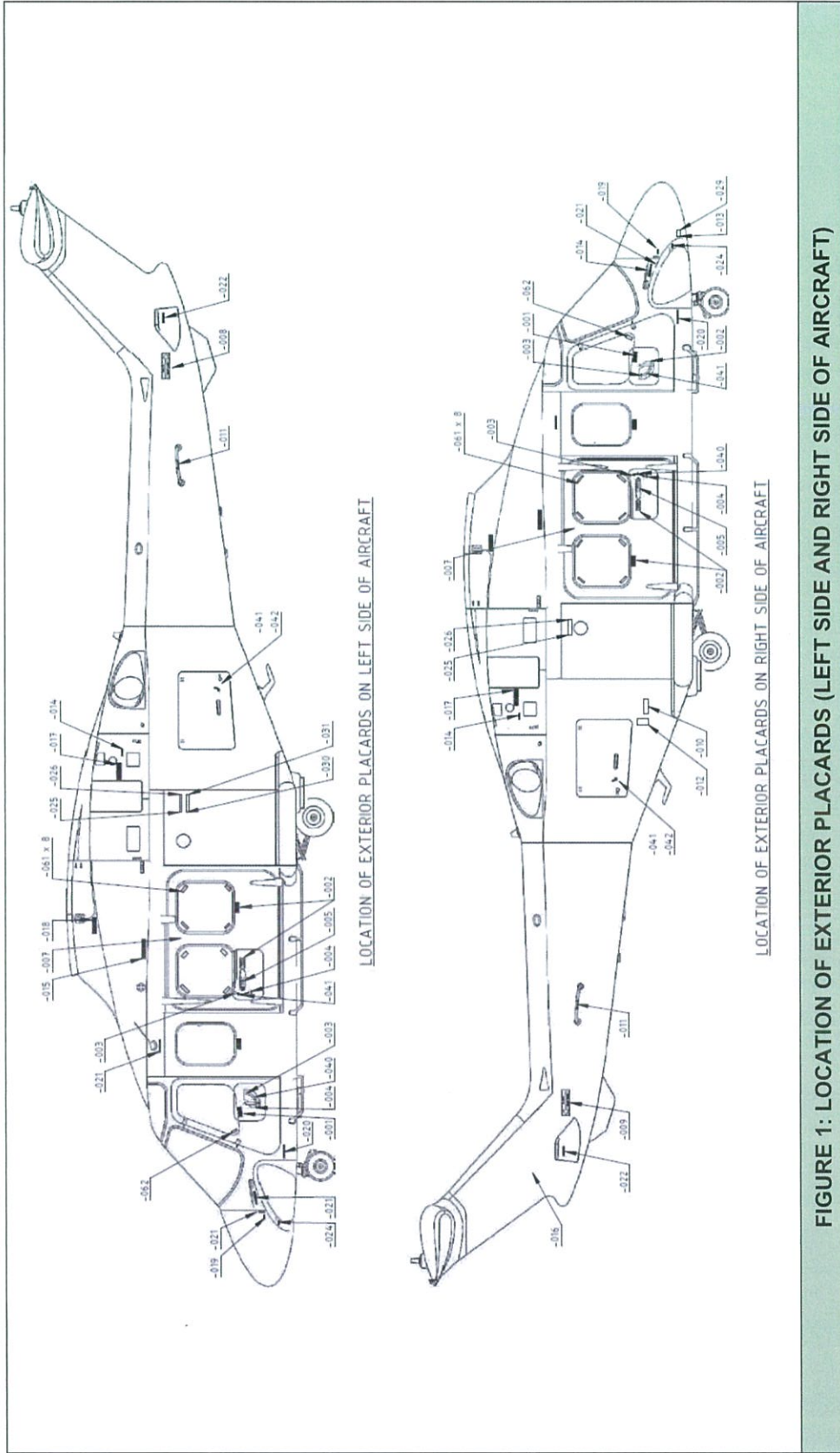
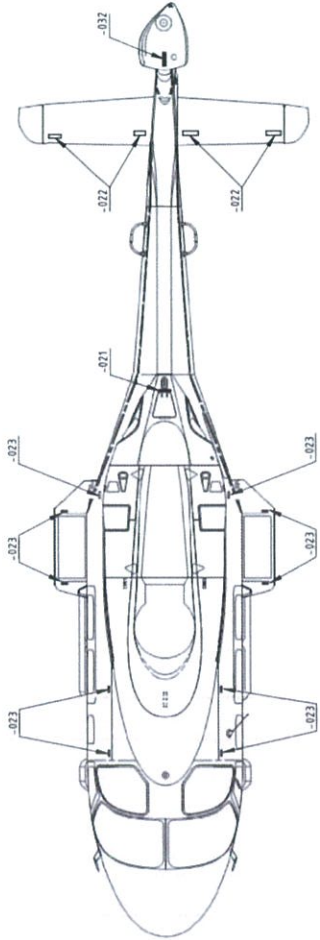
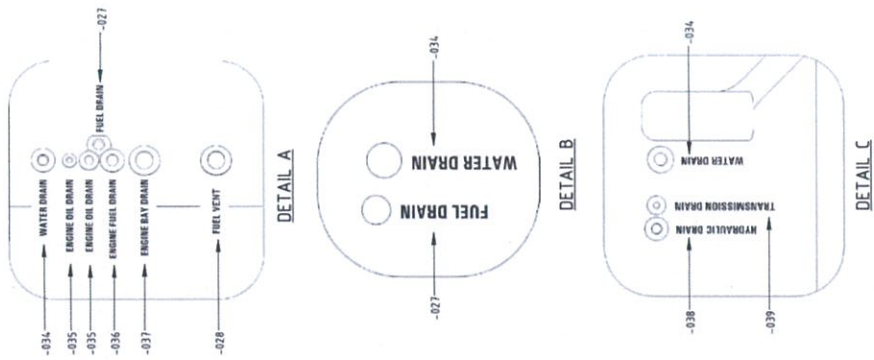

**FIGURE 1: LOCATION OF EXTERIOR PLACARDS (LEFT SIDE AND RIGHT SIDE OF AIRCRAFT)**

This document is the property of GALAXY AEROSPACE (M) SDN. BHD. (1040262-D), no part of it shall be reproduced or transmitted to third parties without the express prior written authorization of GALAXY AEROSPACE (M) SDN. BHD. nor shall its contents be disclosed.

**CONTROLLED COPY**

Doc. No.	GAM047/ICA
Date	19/03/2021
Revision	0



LOCATION OF EXTERIOR PLACARDS: TOP VIEW

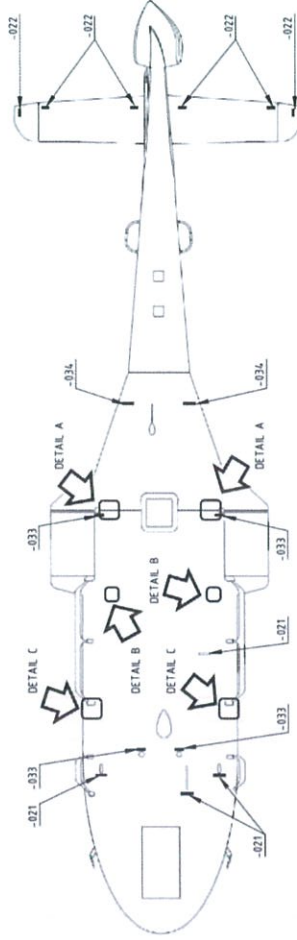

LOCATION OF EXTERIOR PLACARDS: BOTTOM VIEW

**FIGURE 2: LOCATION OF EXTERIOR PLACARDS (TOP AND BOTTOM VIEW)**



 <b>Galaxy Aerospace</b> <i>maintenance . repair . overhaul</i> <b>INSTRUCTIONS FOR CONTINUED AIRWORTHINESS</b>	<b>INSTALLATION OF PLACARDS AND MARKINGS ON LEONARDO S.p.A AW139</b>	
	Doc. No.	GAM047/ICA
	Date	19/03/2021
	Revision	0

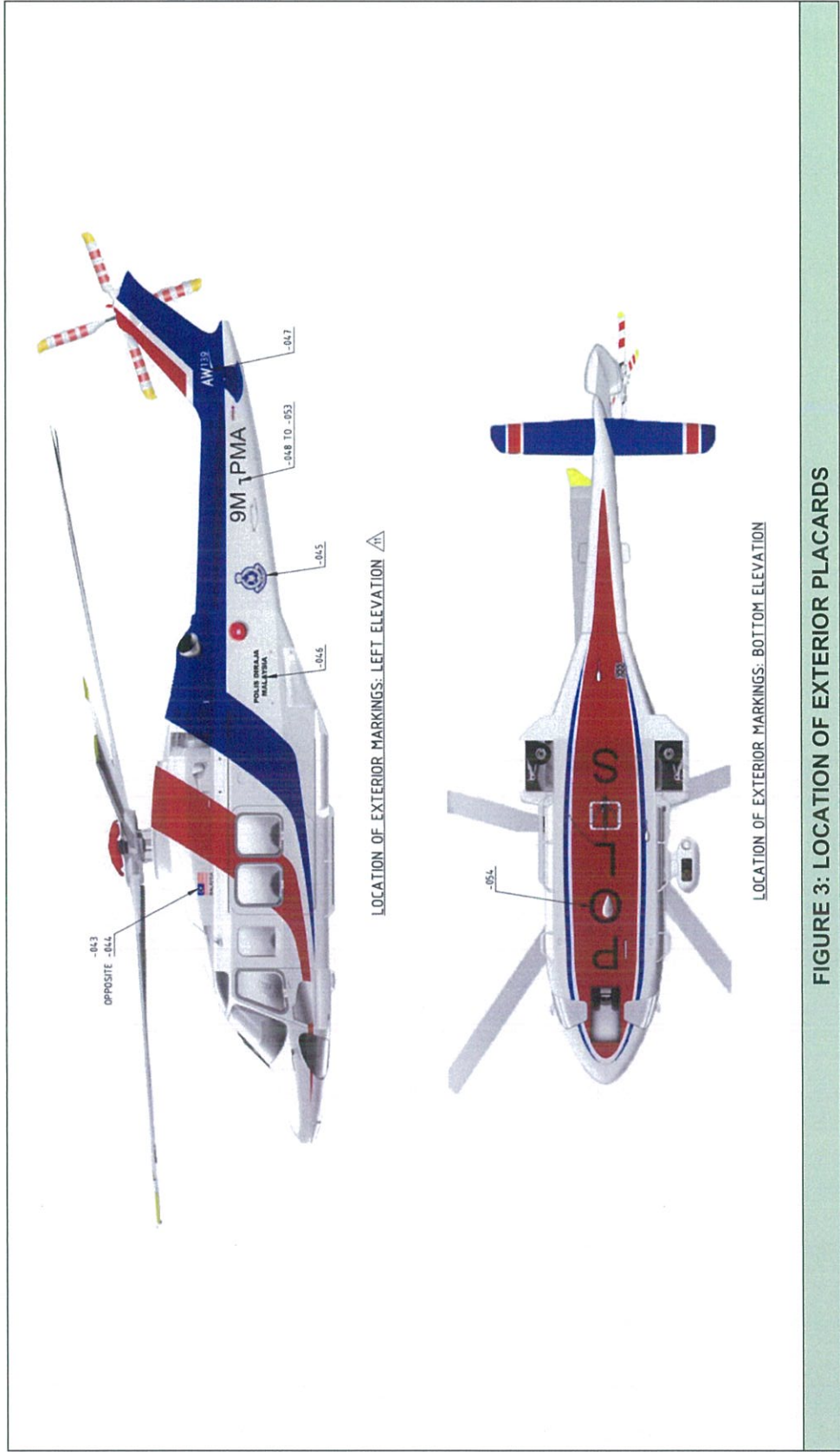

**FIGURE 3: LOCATION OF EXTERIOR PLACARDS**

This document is the property of GALAXY AEROSPACE (M) SDN. BHD. (1040262-D), no part of it shall be reproduced or transmitted to third parties without the express prior written authorization of GALAXY AEROSPACE (M) SDN. BHD. nor shall its contents be disclosed.

CONTROLLED COPY



Doc. No.	GAM047/ICA
Date	19/03/2021
Revision	0

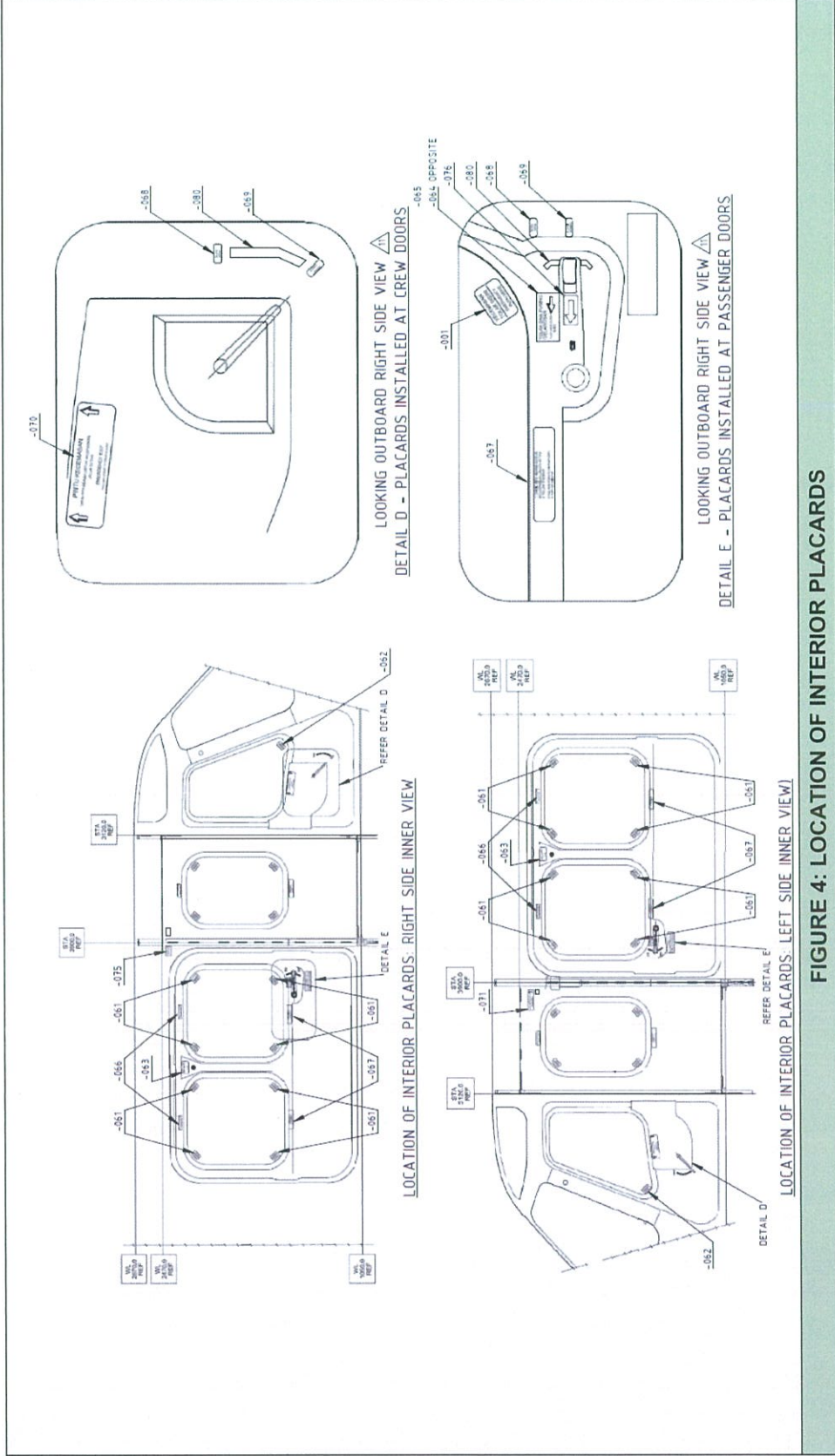

**FIGURE 4: LOCATION OF INTERIOR PLACARDS**

 <b>Galaxy Aerospace</b> maintenance . repair . overhaul <b>INSTRUCTIONS FOR CONTINUED AIRWORTHINESS</b>	<b>INSTALLATION OF PLACARDS AND MARKINGS ON LEONARDO S.p.A AW139</b>	
	Doc. No.	GAM047/ICA
	Date	19/03/2021
	Revision	0

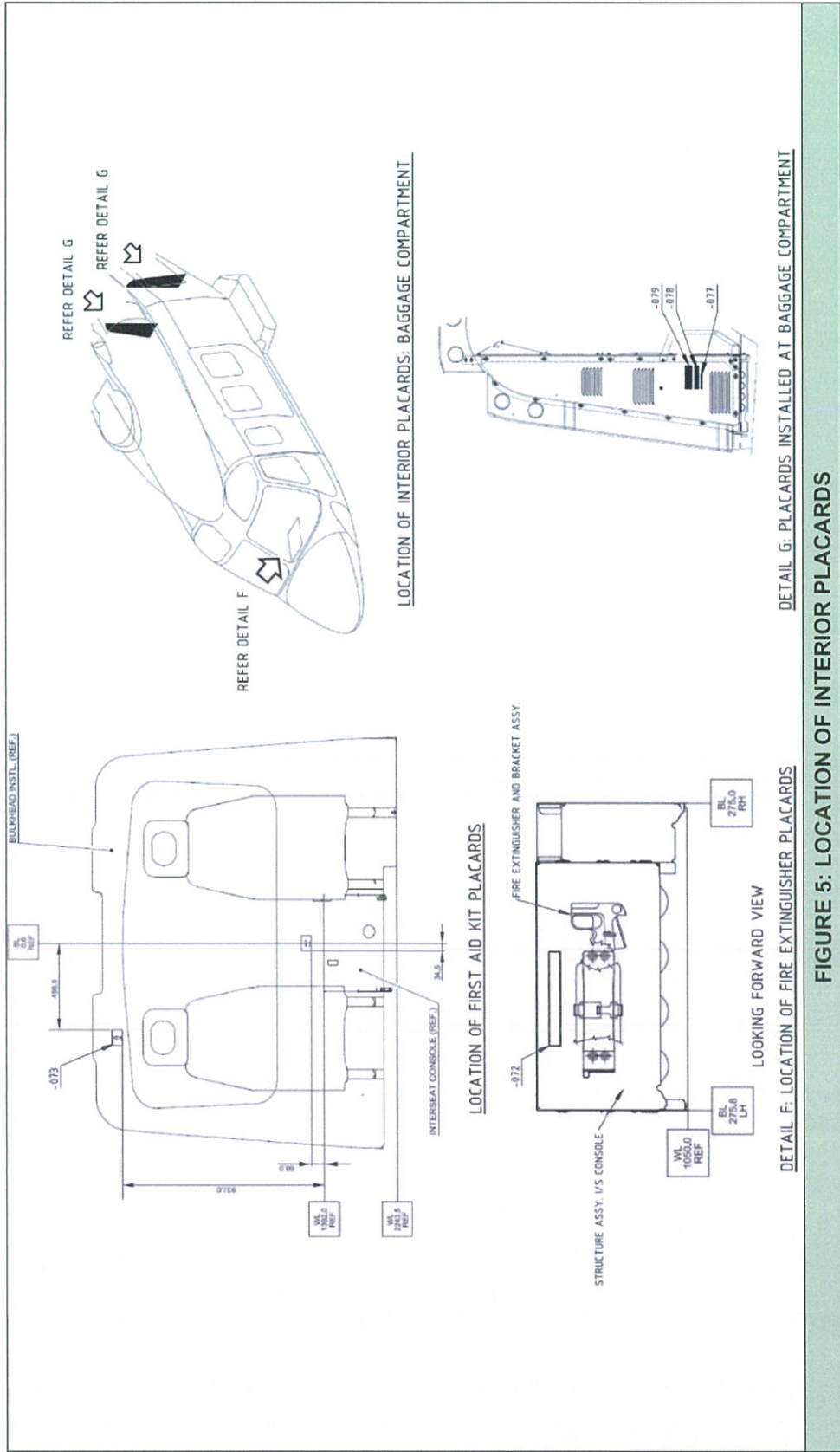

**FIGURE 5: LOCATION OF INTERIOR PLACARDS**

This document is the property of GALAXY AEROSPACE (M) SDN. BHD. (1040262-D), no part of it shall be reproduced or transmitted to third parties without the express prior written authorization of GALAXY AEROSPACE (M) SDN. BHD. nor shall its contents be disclosed.

**CONTROLLED COPY**









**INSTRUCTIONS FOR CONTINUED AIRWORTHINESS**

**INSTALLATION OF PLACARDS AND MARKINGS ON LEONARDO S.p.A AW139**

Doc. No.	GAM047/ICA
Date	19/03/2021
Revision	0

Placards are applied to aircraft listed in INTRODUCTION, Para 1 – Effectively unless otherwise specified.

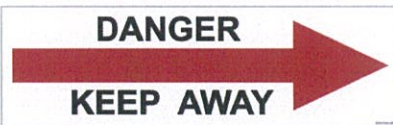
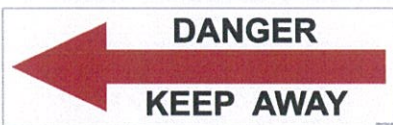
ITEM NO	PLACARDS	PART NUMBER (P/N)	QTY	REMARKS
1.		ED047002-001	2	Nil
2.		ED047002-002	4	Nil
3.		ED047002-003	4	Nil
4.		ED047002-004	4	Nil
5.		ED047002-005	1	Nil
6.		ED047002-006	1	Nil
7.		ED047002-007	2	Nil
8.		ED047002-008	1	Nil
9.		ED047002-009	1	Nil















**INSTRUCTIONS FOR CONTINUED  
AIRWORTHINESS**

**INSTALLATION OF PLACARDS AND  
MARKINGS ON LEONARDO S.p.A AW139**

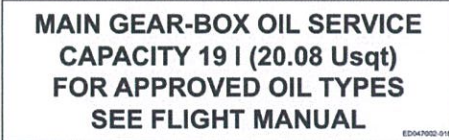
Doc. No.	GAM047/ICA
Date	19/03/2021
Revision	0











ITEM NO	PLACARDS	PART NUMBER (P/N)	QTY	REMARKS
10.		ED047002-010	1	Nil
11.		ED047002-011	2	Nil
12.		ED047002-012	1	Nil
13.		ED047002-013	1	Nil
14.		ED047002-014	2	Nil
15.		ED047002-015	1	Nil
16.		ED047002-016	1	Nil
17.		ED047002-017	2	Nil
18.		ED047002-018	1	Nil
19.		ED047002-019	2	Nil

This document is the property of GALAXY AEROSPACE (M) SDN. BHD. (1040262-D), no part of it shall be reproduced or transmitted to third parties without the express prior written authorization of GALAXY AEROSPACE (M) SDN. BHD. nor shall its contents be disclosed.

**INSTRUCTIONS FOR CONTINUED  
AIRWORTHINESS**

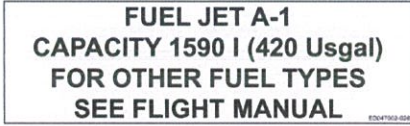
**INSTALLATION OF PLACARDS AND  
MARKINGS ON LEONARDO S.p.A AW139**

Doc. No.	GAM047/ICA
Date	19/03/2021
Revision	0

ITEM NO	PLACARDS	PART NUMBER (P/N)	QTY	REMARKS
20.		ED047002-020	2	Nil
21.		ED047002-021	8	Nil
22.		ED047002-022	10	Nil
23.		ED047002-023	10	Nil
24.		ED047002-024	2	Nil
25.		ED047002-025	2	Nil
26.		ED047002-026	2	Nil
27.		ED047002-027	4	Nil
28.		ED047002-028	2	Nil
29.		ED047002-029	1	Nil









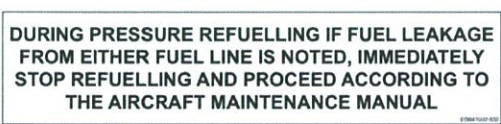

This document is the property of GALAXY AEROSPACE (M) SDN. BHD. (1040262-D), no part of it shall be reproduced or transmitted to third parties without the express prior written authorization of GALAXY AEROSPACE (M) SDN. BHD. nor shall its contents be disclosed.



**INSTRUCTIONS FOR CONTINUED  
AIRWORTHINESS**

**INSTALLATION OF PLACARDS AND  
MARKINGS ON LEONARDO S.p.A AW139**





Doc. No.	GAM047/ICA
Date	19/03/2021
Revision	0

ITEM NO	PLACARDS	PART NUMBER (P/N)	QTY	REMARKS
30.		ED047002-030	1	Nil
31.		ED047002-031	1	Nil
32.		ED047002-032	1	Nil
33.		ED047002-033	4	Nil
34.		ED047002-034	8	Nil
35.		ED047002-035	4	Nil
36.		ED047002-036	2	Nil
37.		ED047002-037	2	Nil
38.		ED047002-038	2	Nil
39.		ED047002-039	2	Nil

This document is the property of GALAXY AEROSPACE (M) SDN. BHD. (1040262-D), no part of it shall be reproduced or transmitted to third parties without the express prior written authorization of GALAXY AEROSPACE (M) SDN. BHD. nor shall its contents be disclosed.



Doc. No.	GAM047/ICA
Date	19/03/2021
Revision	0

ITEM NO	PLACARDS	PART NUMBER (P/N)	QTY	REMARKS
40.		ED047002-040	3	Nil
41.		ED047002-041	3	Nil
42.	<div style="border: 1px solid black; padding: 5px; text-align: center;"> <p><b>ENSURE LATCHES ARE            FULLY ENGAGED IN            CLOSED POSITION</b></p> <p><small>ED047002-042</small></p> </div>	ED047002-042	2	Nil
43.	 <b>MALAYSIA</b>	ED047002-043	1	Nil
44.	 <b>MALAYSIA</b>	ED047002-044	1	Nil

Doc. No.	GAM047/ICA
Date	19/03/2021
Revision	0

ITEM NO	PLACARDS	PART NUMBER (P/N)	QTY	REMARKS
45.		ED047002-045	2	Nil
46.	<b>POLIS DIRAJA MALAYSIA</b>	ED047002-046	2	Nil
47.	<b>AW139</b>	ED047002-047	2	Nil
48.	<b>9M-PMA</b>	ED047002-048	2	9M-PMA
49.	<b>9M-PMB</b>	ED047002-049	2	9M-PMB
50.	<b>9M-PMC</b>	ED047002-050	2	9M-PMC
51.	<b>9M-PMD</b>	ED047002-051	2	9M-PMD
52.	<b>9M-PME</b>	ED047002-052	2	9M-PME
53.	<b>9M-PMF</b>	ED047002-053	2	9M-PMF





**INSTRUCTIONS FOR CONTINUED AIRWORTHINESS**

**INSTALLATION OF PLACARDS AND MARKINGS ON LEONARDO S.p.A AW139**

Doc. No.	GAM047/ICA
Date	19/03/2021
Revision	0









ITEM NO	PLACARDS	PART NUMBER (P/N)	QTY	REMARKS
54.		ED047002-054	1	Nil
55.		ED047002-061	32	Nil
56.		ED047002-062	4	Nil
57.		ED047002-063	2	Nil
58.		ED047002-064	1	Nil
59.		ED047002-065	1	Nil
60.		ED047002-066	4	Nil
61.		ED047002-067	4	Nil
62.		ED047002-068	4	Nil



**INSTRUCTIONS FOR CONTINUED AIRWORTHINESS**

**INSTALLATION OF PLACARDS AND MARKINGS ON LEONARDO S.p.A AW139**

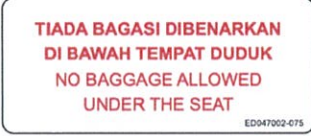
Doc. No.	GAM047/ICA
Date	19/03/2021
Revision	0

ITEM NO	PLACARDS	PART NUMBER (P/N)	QTY	REMARKS
63.		ED047002-069	4	Nil
64.		ED047002-070	2	Nil
65.		ED047002-071	2	Nil
66.		ED047002-072	1	Nil
67.		ED047002-073	1	Nil
68.		ED047002-074	1	Nil
69.		ED047002-075	1	Nil
70.		ED047002-076	2	Nil
71.		ED047002-077	2	Nil



This document is the property of GALAXY AEROSPACE (M) SDN. BHD. (1040262-D), no part of it shall be reproduced or transmitted to third parties without the express prior written authorization of GALAXY AEROSPACE (M) SDN. BHD. nor shall its contents be disclosed.



**INSTRUCTIONS FOR CONTINUED  
 AIRWORTHINESS**

**INSTALLATION OF PLACARDS AND  
 MARKINGS ON LEONARDO S.p.A AW139**

Doc. No.	GAM047/ICA
Date	19/03/2021
Revision	0

ITEM NO	PLACARDS	PART NUMBER (P/N)	QTY	REMARKS
72.		ED047002-078	2	Nil
73.		ED047002-079	2	Nil
74.		ED047002-080	2	Nil

