



CIVIL AVIATION DIRECTIVE – 6 PART 1

COMMERCIAL AIR TRANSPORT

AEROPLANE

CIVIL AVIATION AUTHORITY OF MALAYSIA

INTENTIONALLY LEFT BLANK

Introduction

In exercise of the powers conferred by Section 24O of the Civil Aviation Act 1969 [Act 3], the Chief Executive Officer makes this Civil Aviation Directive 6 Part 1 – Commercial Air Transport – Aeroplane (“CAD 6 Part 1 – CAT – Aeroplane”), pursuant to Regulation(s) 26, 31, 38, 39, 40, 41, 42, 46, 43, 48, 49, 75, 81, 83, 85, 86, 89, 90, 91, 93, 96, 99, 101, 105, 106, 107, 108, 109, 110, 111, 112, 114, 118, 120, 121, 122, 125, 127, 129, 130, 160, 161 of the Malaysian Civil Aviation Regulations (MCAIR) 2016.

This CAD contains the standards, requirements and procedures pertaining to Commercial Air Transport operations. The standards and requirements in this CAD are based mainly on the Standards and Recommended Practices (SARPs) contained in the International Civil Aviation Organisation (ICAO) Annex 6 Part 1 to the Chicago Convention – Operation of Aircraft: International Commercial Air Transport – Aeroplane, Amendment 44.

Civil Aviation Directive 6 Part 1 – Commercial Air Transport – Aeroplane (“CAD 6 Part 1 – CAT – Aeroplane”) is published by the Chief Executive Officer under Section 24O of the Civil Aviation Act 1969 [Act 3] and comes into operation on 1st April 2021.

Non-compliance with this CAD

Any person who contravenes any provision in this CAD commits an offence and shall on conviction be liable to the punishments under Section 24O (2) of the Civil Aviation Act 1969 [Act 3] and/or under Malaysia Civil Aviation Regulation 2016.

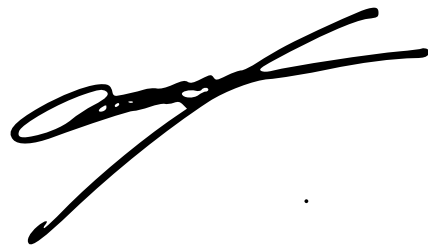

(Captain Chester Voo Chee Soon)
Chief Executive Officer
Civil Aviation Authority of Malaysia

Civil Aviation Directive components and Editorial practices

This Civil Aviation Directive is made up of the following components and are defined as follows:

Standards: Usually preceded by words such as “*shall*” or “*must*”, are any specification for physical characteristics, configuration, performance, personnel or procedure, where uniform application is necessary for the safety or regularity of air navigation and to which Operators must conform. In the event of impossibility of compliance, notification to the CAAM is compulsory.

Recommended Practices: Usually preceded by the words such as “*should*” or “*may*”, are any specification for physical characteristics, configuration, performance, personnel or procedure, where the uniform application is desirable in the interest of safety, regularity or efficiency of air navigation, and to which Operators will endeavour to conform.

Appendices: Material grouped separately for convenience but forms part of the Standards and Recommended Practices stipulated by the CAAM.

Definitions: Terms used in the Standards and Recommended Practices which are not self-explanatory in that they do not have accepted dictionary meanings. A definition does not have an independent status but is an essential part of each Standard and Recommended Practice in which the term is used, since a change in the meaning of the term would affect the specification.

Tables and Figures: These add to or illustrate a Standard or Recommended Practice and which are referred to therein, form part of the associated Standard or Recommended Practice and have the same status.

Notes: Included in the text, where appropriate, Notes give factual information or references bearing on the Standards or Recommended Practices in question but not constituting part of the Standards or Recommended Practices;

Attachments: Material supplementary to the Standards and Recommended Practices or included as a guide to their application.

It is to be noted that some Standards in this Civil Aviation Directive incorporates, by reference, other specifications having the status of Recommended Practices. In such cases, the text of the Recommended Practice becomes part of the Standard.

The units of measurement used in this document are in accordance with the International System of Units (SI) as specified in CAD 5. Where CAD 5 permits the use of non-SI alternative units, these are shown in parentheses following the basic units. Where two sets of units are quoted it must not be assumed that the pairs of values are equal and interchangeable. It may, however, be inferred that an equivalent level of safety is achieved when either set of units is used exclusively.

Any reference to a portion of this document, which is identified by a number and/or title, includes all subdivisions of that portion.

Throughout this Civil Aviation Directive, the use of the male gender should be understood to include male and female persons.



INTENTIONALLY LEFT BLANK



Table of contents

1	GENERAL	1-1
1.1	CITATION	1-1
1.2	APPLICABILITY	1-1
1.3	REVOCATION	1-1
1.4	DEFINITIONS AND ABBREVIATION	1-2
2	REFERENCES	2-17
3	GENERAL REQUIREMENTS	3-19
3.1	COMPLIANCE WITH LAWS, REGULATIONS AND PROCEDURES	3-19
3.2	COMPLIANCE BY A FOREIGN OPERATOR WITH LAWS, REGULATIONS AND PROCEDURES OF MALAYSIA	3-20
3.3	SAFETY MANAGEMENT	3-22
3.4	USE OF PSYCHOACTIVE SUBSTANCES	3-23
3.5	AIRCRAFT TRACKING	3-24
4	FLIGHT OPERATIONS	4-1
4.1	OPERATING FACILITIES	4-1
4.2	OPERATIONAL CERTIFICATION AND SUPERVISION	4-2
4.3	FLIGHT PREPARATION	4-19
4.4	IN-FLIGHT PROCEDURES	4-36
4.5	DUTIES OF PILOT-IN-COMMAND	4-40
4.6	DUTIES OF FLIGHT OPERATIONS OFFICER/FLIGHT DISPATCHER	4-42
4.7	ADDITIONAL REQUIREMENTS FOR OPERATIONS BY AEROPLANES WITH TURBINE ENGINES BEYOND 60 MINUTES TO AN EN-ROUTE ALTERNATE AERODROME INCLUDING EXTENDED DIVERSION TIME OPERATIONS (EDTO)	4-43
4.8	CARRY-ON BAGGAGE	4-46
4.9	ADDITIONAL REQUIREMENTS FOR SINGLE PILOT OPERATIONS UNDER THE INSTRUMENT FLIGHT RULES (IFR) OR AT NIGHT	4-47
4.10	FATIGUE MANAGEMENT	4-47
4.11	ADDITIONAL REQUIREMENTS FOR LOW VISIBILITY OPERATIONS (LVO)	4-47
5	AEROPLANE PERFORMANCE OPERATING LIMITATIONS	5-1
5.1	GENERAL	5-1
5.2	APPLICABLE TO AEROPLANES CERTIFICATED IN ACCORDANCE WITH PARTS IIIA AND IIIB OF CAD 8	5-2
5.3	OBSTACLE DATA	5-5
5.4	ADDITIONAL REQUIREMENTS FOR OPERATIONS OF SINGLE-ENGINE TURBINE-POWERED AEROPLANES AT NIGHT AND/OR IN INSTRUMENT METEOROLOGICAL CONDITIONS (IMC)	5-5
6	AEROPLANE INSTRUMENTS, EQUIPMENT AND FLIGHT DOCUMENTS	6-1
6.1	GENERAL	6-1
6.2	ALL AEROPLANES ON ALL FLIGHTS	6-4
6.3	FLIGHT RECORDERS	6-11
6.4	ALL AEROPLANES OPERATED AS VFR FLIGHTS	6-19
6.5	ALL AEROPLANES ON FLIGHTS OVER WATER	6-20
6.6	ALL AEROPLANES ON FLIGHTS OVER DESIGNATED LAND AREAS	6-22
6.7	ALL AEROPLANES ON HIGH ALTITUDE FLIGHTS	6-23
6.8	ALL AEROPLANES IN ICING CONDITIONS	6-24
6.9	ALL AEROPLANES OPERATED IN ACCORDANCE WITH INSTRUMENT FLIGHT RULES	6-24
6.10	ALL AEROPLANES WHEN OPERATED AT NIGHT	6-26
6.11	AIRBORNE WEATHER DETECTING EQUIPMENT	6-26
6.12	ALL AEROPLANES OPERATED ABOVE 15 000 M (49 000 FT) — RADIATION INDICATOR	6-27
6.13	ALL AEROPLANES COMPLYING WITH THE NOISE CERTIFICATION STANDARDS IN ANNEX 16, VOLUME I	6-27



6.14	MACH NUMBER INDICATOR.....	6-27
6.15	AEROPLANES REQUIRED TO BE EQUIPPED WITH GROUND PROXIMITY WARNING SYSTEMS (GPWS)	6-27
6.16	AEROPLANES CARRYING PASSENGERS — CABIN CREW SEATS	6-28
6.17	EMERGENCY LOCATOR TRANSMITTER (ELT).....	6-28
6.18	LOCATION OF AN AEROPLANE IN DISTRESS	6-30
6.19	AEROPLANES REQUIRED TO BE EQUIPPED WITH AN AIRBORNE COLLISION AVOIDANCE SYSTEM (ACAS II).....	6-30
6.20	REQUIREMENTS FOR PRESSURE-ALTITUDE REPORTING TRANSPONDERS / ALTITUDE ALERTING SYSTEM.....	6-31
6.21	MICROPHONES / INTERPHONES / PUBLIC ADDRESS SYSTEM.....	6-31
6.22	TURBO-JET AEROPLANES — FORWARD-LOOKING WIND SHEAR WARNING SYSTEM	6-32
6.23	ALL AEROPLANES OPERATED BY A SINGLE PILOT UNDER THE INSTRUMENT FLIGHT RULES (IFR) OR AT NIGHT	6-33
6.24	AEROPLANES EQUIPPED WITH AUTOMATIC LANDING SYSTEMS, A HEAD-UP DISPLAY (HUD) OR EQUIVALENT DISPLAYS, ENHANCED VISION SYSTEMS (EVS), SYNTHETIC VISION SYSTEMS (SVS) AND/OR COMBINED VISION SYSTEMS (CVS)	6-33
6.25	ELECTRONIC FLIGHT BAG (EFB).....	6-34
6.26	CREW PROTECTIVE BREATHING EQUIPMENT	6-36
7	AEROPLANE COMMUNICATION, NAVIGATION AND SURVEILLANCE EQUIPMENT	7-1
7.1	COMMUNICATION EQUIPMENT	7-1
7.2	NAVIGATION EQUIPMENT	7-2
7.3	SURVEILLANCE EQUIPMENT	7-7
7.4	INSTALLATION.....	7-8
7.5	ELECTRONIC NAVIGATION DATA MANAGEMENT	7-8
7.6	PERFORMANCE BASED COMMUNICATION AND SURVEILLANCE (PBCS)	7-9
8	AEROPLANE CONTINUING AIRWORTHINESS.....	8-1
8.1	OPERATOR’S CONTINUING AIRWORTHINESS RESPONSIBILITIES.	8-1
8.2	CONTINUING AIRWORTHINESS MANAGEMENT EXPOSITION	8-1
8.3	MAINTENANCE PROGRAMME.	8-2
8.4	CONTINUING AIRWORTHINESS RECORDS.	8-2
8.5	CONTINUING AIRWORTHINESS INFORMATION	8-3
8.6	MODIFICATIONS AND REPAIRS	8-3
8.7	APPROVED MAINTENANCE ORGANISATION	8-3
8.8	MAINTENANCE RELEASE	8-3
9	AEROPLANE FLIGHT CREW	9-1
9.1	COMPOSITION OF THE FLIGHT CREW.....	9-1
9.2	FLIGHT CREW MEMBER EMERGENCY DUTIES.....	9-3
9.3	FLIGHT CREW MEMBER TRAINING PROGRAMMES	9-3
9.4	QUALIFICATIONS	9-9
9.5	FLIGHT CREW EQUIPMENT (SPARE CORRECTIVE LENSES)	9-14
9.6	ATTESTATION CERTIFICATE.....	9-14
10	FLIGHT OPERATIONS OFFICER/FLIGHT DISPATCHER.....	10-1
11	MANUALS, LOGS AND RECORDS.....	11-3
11.1	FLIGHT MANUAL	11-3
11.2	OPERATOR’S CONTINUING AIRWORTHINESS MANAGEMENT EXPOSITION	11-3
11.3	MAINTENANCE PROGRAMME	11-4
11.4	JOURNEY LOG BOOK	11-4
11.5	RECORDS OF EMERGENCY AND SURVIVAL EQUIPMENT CARRIED.....	11-5
11.6	FLIGHT RECORDER RECORDS	11-5
11.7	INFORMATION TO BE RETAINED ON THE GROUND.....	11-6
12	CABIN CREW	12-1
12.1	ASSIGNMENT OF EMERGENCY DUTIES	12-1



12.2	CABIN CREW AT EMERGENCY EVACUATION STATIONS	12-1
12.3	PROTECTION OF CABIN CREW DURING FLIGHT.....	12-1
12.4	TRAINING	12-1
13	SECURITY	13-1
13.1	DOMESTIC COMMERCIAL OPERATIONS.....	13-1
13.2	SECURITY OF THE FLIGHT CREW COMPARTMENT.....	13-1
13.3	AEROPLANE SEARCH PROCEDURE CHECKLIST	13-2
13.4	TRAINING PROGRAMMES	13-2
13.5	REPORTING ACTS OF UNLAWFUL INTERFERENCE.....	13-3
13.6	MISCELLANEOUS.....	13-3
14	DANGEROUS GOODS	14-1
14.1	STATE RESPONSIBILITIES.....	14-1
14.2	OPERATORS WITH NO SPECIFIC APPROVAL TO TRANSPORT DANGEROUS GOODS AS CARGO.....	14-1
14.3	OPERATORS WITH SPECIFIC APPROVAL FOR THE TRANSPORT OF DANGEROUS GOODS AS CARGO	14-4
14.4	PROVISION OF INFORMATION	14-7
14.5	DOMESTIC COMMERCIAL AIR TRANSPORT OPERATIONS	14-8
15	CARGO COMPARTMENT SAFETY	15-1
15.1	TRANSPORT OF ITEMS IN THE CARGO COMPARTMENT	15-1
15.2	FIRE PROTECTION.....	15-1
16	APPENDICES	16-1
16.1	APPENDIX 1 – LIGHTS TO BE DISPLAYED BY AEROPLANES	16-1
16.2	APPENDIX 2 – ORGANISATION AND CONTENTS OF AN OPERATIONS MANUAL.....	16-5
16.3	APPENDIX 3 – ADDITIONAL REQUIREMENTS FOR APPROVED OPERATIONS BY SINGLE-ENGINE TURBINE-POWERED AEROPLANES AT NIGHT AND/OR IN INSTRUMENT METEOROLOGICAL CONDITIONS (IMC).....	16-21
16.4	APPENDIX 4 – ALTIMETRY SYSTEM PERFORMANCE REQUIREMENTS FOR OPERATIONS IN RVSM AIRSPACE.....	16-23
16.5	APPENDIX 5 – SAFETY OVERSIGHT OF AIR OPERATORS	16-25
16.6	APPENDIX 6 – AIR OPERATORS CERTIFICATE (AOC).....	16-27
16.7	APPENDIX 7 – FATIGUE RISK MANAGEMENT SYSTEM REQUIREMENTS.....	16-29
16.8	APPENDIX 8 – FLIGHT RECORDERS.....	16-31
16.9	APPENDIX 9 – LOCATION OF AN AEROPLANE IN DISTRESS.....	16-47
16.10	APPENDIX 10 – AEROPLANE PERFORMANCE CLASSES	16-49
17	ATTACHMENTS	17-1
17.1	ATTACHMENT A – MEDICAL SUPPLIES	17-1
17.2	ATTACHMENT B - AEROPLANE PERFORMANCE OPERATING LIMITATIONS.....	17-5
17.3	ATTACHMENT C. GUIDANCE FOR OPERATIONS BY TURBINE-ENGINED AEROPLANES BEYOND 60 MINUTES TO AN EN-ROUTE ALTERNATE AERODROME INCLUDING EXTENDED DIVERSION TIME OPERATIONS (EDTO)	17-7
17.4	ATTACHMENT D. AIR OPERATOR CERTIFICATION AND VALIDATION	17-9
17.5	ATTACHMENT E. MINIMUM EQUIPMENT LIST (MEL)	17-11
17.6	ATTACHMENT F. FLIGHT SAFETY DOCUMENT SYSTEM.....	17-13
17.7	ATTACHMENT G. ADDITIONAL GUIDANCE FOR APPROVED OPERATIONS BY SINGLE-ENGINE TURBINE-POWERED AEROPLANES AT NIGHT AND/OR IN INSTRUMENT METEOROLOGICAL CONDITIONS (IMC)	17-17
17.8	ATTACHMENT H. AUTOMATIC LANDING SYSTEMS, DISPLAYS AND VISION SYSTEMS.....	17-19
17.9	ATTACHMENT I. RESCUE AND FIRE FIGHTING SERVICES (RFFS) LEVELS	17-29
17.10	ATTACHMENT J. DANGEROUS GOODS	17-35
17.11	ATTACHMENT K. LOCATION OF AN AEROPLANE IN DISTRESS.....	17-37
17.12	ATTACHMENT L. GUIDE TO CURRENT FLIGHT RECORDER PROVISIONS.....	17-39



INTENTIONALLY LEFT BLANK

1 General

1.1 Citation

- 1.1.1 These Directives are the Civil Aviation Directive 6 Part 1 – Commercial Air Transport – Aeroplane (CAD 6 Part 1 – CAT – Aeroplane), Issue 01/Revision 00, and comes into operation on 1st April 2021.
- 1.1.2 This CAD 6 Part 1 – CAT – Aeroplane, Issue 01/Revision 00 will remain current until withdrawn or superseded.

1.2 Applicability

- 1.2.1 This CAD applies to all operators holding a Malaysian AOC, crew conducting commercial air transport operations that involve aeroplanes, and Continuing Airworthiness Management Organisations of the Malaysian AOC.

1.3 Revocation

- 1.3.1 This CAD, in conjunction with CAD 6 Part 3 – Helicopters revokes 60CA-16 Issue 2 Amendment 1, Flight Operations Directive – Commercial Air Transport dated 15 July 2019.
- 1.3.2 This CAD revokes ORO.SEC.100.A of SUBPART SEC – SECURITY of the Flight Operations Directive – Organisation Requirements For Air Operations 60OR-16 Issue 3 Amendment 0 dated 15 July 2019.
- 1.3.3 This CAD also revokes:
- a) Notice 6403 Airworthiness Requirement: Aircraft Leasing Arrangement issue 1 dated 15th July 2019
 - b) Notice 6204 Electronic Flight Bag issue 1 dated 18th May 2020
 - c) Notice 6301 Reduced Vertical Separation Minima (RVSM) issue 1 dated 15th July 2019
 - d) Notice 6302 Performance-Based Navigation (PBN) – Airworthiness Review issue 1 dated 17th June 2020
 - e) Notice 6304 Extended Diversion Time Operations (EDTO) issue 1 dated 15th July 2019
 - f) Notice 6305 Performance-Based Communication and Surveillance (PBCS) – Airworthiness Review issue 1 dated 17th June 2020
 - g) Notice 6306 Automatic Dependent Surveillance – Broadcast Out (ADS-B OUT) – Airworthiness Review issue 1 dated 17th June 2020
 - h) Notice 6307 Low Visibility Operations (LVO) – Airworthiness Review issue 1 dated 13th October 2020

- i) Airworthiness Notice 79 Aeroplanes Required to Be Equipped with Ground Proximity Warning System (GPWS) – Commercial Air Transport issue 1 dated 1st October 2002
- j) Airworthiness Notice 83 Flight Recorders – Aeroplane issue 2 dated 15th May 200

1.4 Definitions and Abbreviation

Definitions

When the following terms are used in this CAD, they have the following meanings:

Accelerate-stop distance available (ASDA) means the length of the take-off run available plus the length of stopway, if provided.

Aerial work means an aircraft operation in which an aircraft is used for specialised services in agriculture, construction, photography, surveying, observation and patrol, search and rescue, aerial advertisement, and other similar activities.

Aerodrome means a defined area on land or water (including any buildings, installations and equipment) intended to be used either wholly or in part for the arrival, departure and surface movement of aircraft.

Aerodrome operating minima means the limits of usability of an aerodrome for:

- a) take-off, expressed in terms of runway visual range and/or visibility and, if necessary, cloud conditions;
- b) landing in two dimensional (2D) instrument approach operations, expressed in terms of visibility and/or runway visual range, minimum descent altitude/height (MDA/H) and, if necessary, cloud conditions; and
- c) landing in three dimensional (3D) instrument approach operations, expressed in terms of visibility and/or runway visual range and decision altitude/height (DA/H) as appropriate to the type and/or category of the operation.

Aeroplane means a power-driven heavier-than-air aircraft, deriving its lift in flight chiefly from aerodynamic reactions on surfaces which remain fixed under given conditions of flight.

Aircraft means a machine that can derive support in the atmosphere from the reactions of the air other than the reactions of the air against the surface of the earth.

Aircraft operating manual means a manual, acceptable to the CAAM, containing normal, abnormal and emergency procedures, checklists, limitations, performance information, details of the aircraft systems and other material relevant to the operation of the aircraft.

Note.— The aircraft operating manual is part of the operations manual.

Aircraft tracking means a process, established by the operator, that maintains and updates, at standardised intervals, a ground- based record of the four dimensional position of individual aircraft in flight.

Air operator certificate (AOC) means a certificate authorising an operator to carry out specified commercial air transport operations.

Air traffic service (ATS) means a generic term meaning variously, flight information service, alerting service, air traffic advisory service, air traffic control service (area control service,

approach control service or aerodrome control service).

Airworthy means the status of an aircraft, or its engine, propeller or part which conforms to the approved type design and is in a condition for safe operation.

Alternate aerodrome means an aerodrome to which an aircraft may proceed when it becomes either impossible or inadvisable to proceed to or to land at the aerodrome of intended landing where the necessary services and facilities are available, where aircraft performance requirements can be met and which is operational at the expected time of use. Alternate aerodromes include the following:

Take-off alternate. An alternate aerodrome at which an aircraft would be able to land should this become necessary shortly after take-off and it is not possible to use the aerodrome of departure.

En-route alternate. An alternate aerodrome at which an aircraft would be able to land in the event that a diversion becomes necessary while en route.

Destination alternate. An alternate aerodrome at which an aircraft would be able to land should it become either impossible or inadvisable to land at the aerodrome of intended landing.

Note.— The aerodrome from which a flight departs may also be an en-route or a destination alternate aerodrome for that flight.

Altimetry system error (ASE) means the difference between the altitude indicated by the altimeter display, assuming a correct altimeter barometric setting, and the pressure altitude corresponding to the undisturbed ambient pressure.

Approach category of aircraft means a grouping which differentiates aircraft based on the speed at which the aircraft approaches a runway for landing. Details on the categories are found in ICAO Doc 8168 Vol I, Part 2, Section 5.

Appropriate airworthiness requirements means the comprehensive and detailed airworthiness codes established, adopted or accepted by a Contracting State for the class of aircraft, engine or propeller under consideration.

Area navigation (RNAV) means a method of navigation which permits aircraft operation on any desired flight path within the coverage of ground- or space-based navigation aids or within the limits of the capability of self-contained aids, or a combination of these.

Note.— Area navigation includes performance-based navigation as well as other operations that do not meet the definition of performance-based navigation.

Cabin crew member means a crew member who performs, in the interest of safety of passengers, duties assigned by the operator or the pilot-in-command of the aircraft, but does not include a flight crew member.

COMAT means operator material carried on an operator's aircraft for the operator's own purposes.

Combined vision system (CVS) means a system to display images from a combination of an enhanced vision system (EVS) and a synthetic vision system (SVS).

Commercial air transport operation means an aircraft operation involving the transport of passengers, cargo or mail for hire or reward.

Configuration deviation list (CDL) means a list established by the organisation responsible for the type design with the approval of the State of Design which identifies any external parts of an aircraft type which may be missing at the commencement of a flight, and which contains, where necessary, any information on associated operating limitations

and performance correction.

Contaminated runway means a runway is contaminated when a significant portion of the runway surface area (whether in isolated areas or not) within the length and width being used is covered by one or more of the substances listed in the runway surface condition descriptors.

Note.— Further information on runway surface condition descriptors can be found in the CAD 14, Volume I —Definitions.

Continuing airworthiness means the set of processes by which an aircraft, engine, propeller or part complies with the applicable airworthiness requirements and remains in a condition for safe operation throughout its operating life.

Continuing airworthiness records mean records which are related to the continuing airworthiness status of an aircraft, engine, propeller or associated part.

Continuous descent final approach (CDFA) means a technique, consistent with stabilised approach procedures, for flying the final approach segment (FAS) of a non-precision instrument approach (NPA) procedure as a continuous descent, without level-off, from an altitude/height at or above the final approach fix altitude/height to a point approximately 15 m (50 ft) above the landing runway threshold or the point where the flare manoeuvre begins for the type of aircraft flown; for the FAS of an NPA procedure followed by a circling approach, the CDFA technique applies until circling approach minima (circling OCA/H) or visual flight manoeuvre altitude/height are reached.

Crew member means a person assigned by an operator to duty on an aircraft during a flight duty period.

Cruise relief pilot means a flight crew member who is assigned to perform pilot tasks during cruise flight, to allow the pilot-in-command or a co-pilot to obtain planned rest.

Cruising level means a level maintained during a significant portion of a flight.

Dangerous goods means articles or substances which are capable of posing a risk to health, safety, property or the environment and which are shown in the list of dangerous goods in the Technical Instructions or which are classified according to those Instructions.

Note.— Dangerous goods are classified in Annex 18, Chapter 3.

Decision altitude (DA) or decision height (DH) means a specified altitude or height in a three dimensional (3D) instrument approach operation or circling approach operation below which descent must not be made without the required visual reference.

Note 1.— Decision altitude (DA) is referenced to mean sea level and decision height (DH) is referenced to the threshold elevation.

Note 2.— The required visual reference means that section of the visual aids or of the approach area which should have been in view for sufficient time for the pilot to have made an assessment of the aircraft position and rate of change of position, in relation to the desired flight path. In Category III operations with a decision height the required visual reference is that specified for the particular procedure and operation.

Note 3.— For convenience where both expressions are used they may be written in the form “decision altitude/height” and abbreviated “DA/H”.

Dry runway means a runway is considered dry if its surface is free of visible moisture and not contaminated within the area intended to be used.

Duty means any task that flight or cabin crew members are required by the operator to

perform, including, for example, flight duty, administrative work, training, positioning and standby when it is likely to induce fatigue.

Duty period means a period which starts when a flight or cabin crew member is required by an operator to report for or to commence a duty and ends when that person is free from all duties.

EDTO critical fuel means the fuel quantity necessary to fly to an en-route alternate aerodrome considering, at the most critical point on the route, the most limiting system failure.

EDTO significant system means an aeroplane system whose failure or degradation could adversely affect the safety particular to an EDTO flight, or whose continued functioning is specifically important to the safe flight and landing of an aeroplane during an EDTO diversion.

Electronic flight bag (EFB) means an electronic information system, comprised of equipment and applications for flight crew, which allows for the storing, updating, displaying and processing of EFB functions to support flight operations or duties.

Emergency locator transmitter (ELT) means a generic term describing equipment which broadcast distinctive signals on designated frequencies and, depending on application, may be automatically activated by impact or be manually activated. An ELT may be any of the following:

Automatic fixed ELT (ELT(AF)). An automatically activated ELT which is permanently attached to an aircraft.

Automatic portable ELT (ELT(AP)). An automatically activated ELT which is rigidly attached to an aircraft but readily removable from the aircraft.

Automatic deployable ELT (ELT(AD)). An ELT which is rigidly attached to an aircraft and which is automatically deployed and activated by impact, and, in some cases, also by hydrostatic sensors. Manual deployment is also provided.

Survival ELT (ELT(S)). An ELT which is removable from an aircraft, stowed so as to facilitate its ready use in an emergency, and manually activated by survivors.

Engine means a unit used or intended to be used for aircraft propulsion. It consists of at least those components and equipment necessary for functioning and control, but excludes the propeller/rotors (if applicable).

Enhanced vision system (EVS) means a system to display electronic real-time images of the external scene achieved through the use of image sensors.

Note.— EVS does not include night vision imaging systems (NVIS).

Extended diversion time operations (EDTO) means any operation by an aeroplane with two or more turbine engines where the diversion time to an en-route alternate aerodrome is greater than the threshold time established by the CAAM.

Fatigue means a physiological state of reduced mental or physical performance capability resulting from sleep loss, extended wakefulness, circadian phase, and/or workload (mental and/or physical activity) that can impair a person's alertness and ability to perform safety-related operational duties.

Final approach segment (FAS) means that segment of an instrument approach procedure in which alignment and descent for landing are accomplished.

Flight crew member means a licenced crew member charged with duties essential to the operation of an aircraft during a flight duty period.

Note.- As defined in MCAR 2016, flight crew member specifically means in relation to an aircraft, those members of the crew of the aircraft who respectively undertake to act as pilot, flight navigator, flight engineer and flight radiotelephony operator of the aircraft.

Flight data analysis programme means a programme of analysing recorded flight data in order to improve the safety of flight operations.

Flight duty period means a period which commences when a flight or cabin crew member is required to report for duty that includes a flight or a series of flights and which finishes when the aircraft finally comes to rest and the engines are shut down at the end of the last flight on which he is a crew member.

Flight manual means a manual associated with the certificate of airworthiness, containing limitations within which an aircraft is to be considered airworthy, and instructions and information necessary to the flight crew members for the safe operation of the aircraft.

Flight operations officer/flight dispatcher means a person designated by the operator to engage in the control and supervision of flight operations, whether licenced or not, suitably qualified in accordance with Annex 1, who supports, briefs and/or assists the pilot-in-command in the safe conduct of the flight.

Flight plan means specified information provided to air traffic services units, relative to an intended flight or portion of a flight of an aircraft.

Flight recorder means any type of recorder installed in the aircraft for the purpose of complementing accident or incident investigation.

Automatic deployable flight recorder (ADFR). A combination flight recorder installed on the aircraft which is capable of automatically deploying from the aircraft.

Flight safety documents system means a set of interrelated documentation established by the operator, compiling and organising information necessary for flight and ground operations, and comprising, as a minimum, the operations manual and the operator's continuing airworthiness management exposition.

Flight simulation training device means any one of the following three types of apparatus in which flight conditions are simulated on the ground:

Flight simulator, which provides an accurate representation of the flight deck of a particular aircraft type to the extent that the mechanical, electrical, electronic, etc. aircraft systems control functions, the normal environment of flight crew members, and the performance and flight characteristics of that type of aircraft are realistically simulated;

Flight procedures trainer, which provides a realistic flight deck environment, and which simulates instrument responses, simple control functions of mechanical, electrical, electronic, etc. aircraft systems, and the performance and flight characteristics of aircraft of a particular class;

Basic instrument flight trainer, which is equipped with appropriate instruments, and which simulates the flight deck environment of an aircraft in flight in instrument flight conditions.

Flight time — aeroplanes means the total time from the moment an aeroplane first moves for the purpose of taking off until the moment it finally comes to rest at the end of the flight.

Note.— Flight time as here defined is synonymous with the term “block to block” time or “chock to chock” time in general usage which is measured from the time an aeroplane first moves for the purpose of taking off until it finally stops at the end of the flight.

General aviation operation means an aircraft operation other than a commercial air

transport operation or an aerial work operation.

Ground handling means services necessary for an aircraft's arrival at, and departure from, an airport, other than air traffic services.

Head-up display (HUD) means a display system that presents flight information into the pilot's forward external field of view.

Human Factors principles means principles which apply to aeronautical design, certification, training, operations and maintenance and which seek safe interface between the human and other system components by proper consideration to human performance.

Human performance means human capabilities and limitations which have an impact on the safety and efficiency of aeronautical operations.

Instrument approach operations means an approach and landing using instruments for navigation guidance based on an instrument approach procedure. There are two methods for executing instrument approach operations:

- a) a two-dimensional (2D) instrument approach operation, using lateral navigation guidance only; and
- b) a three-dimensional (3D) instrument approach operation, using both lateral and vertical navigation guidance.

Note.— Lateral and vertical navigation guidance refers to the guidance provided either by:

- a) a ground-based radio navigation aid; or
- b) computer-generated navigation data from ground-based, space-based, self-contained navigation aids or a combination of these.

Instrument approach procedure (IAP) means a series of predetermined manoeuvres by reference to flight instruments with specified protection from obstacles from the initial approach fix, or where applicable, from the beginning of a defined arrival route to a point from which a landing can be completed and thereafter, if a landing is not completed, to a position at which holding or en-route obstacle clearance criteria apply. Instrument approach procedures are classified as follows:

Non-precision approach (NPA) procedure means an instrument approach procedure designed for 2D instrument approach operations Type A.

Note.— Non-precision approach procedures may be flown using a continuous descent final approach (CDFA) technique. CDFAs with advisory VNAV guidance calculated by on-board equipment are considered 3D instrument approach operations. CDFAs with manual calculation of the required rate of descent are considered 2D instrument approach operations. For more information on CDFAs, refer to PANS-OPS (Doc 8168), Volume I, Part II, Section 5.

Approach procedure with vertical guidance (APV) means a performance-based navigation (PBN) instrument approach procedure designed for 3D instrument approach operations Type A.

Precision approach (PA) procedure means an instrument approach procedure based on navigation systems (ILS, MLS, GLS and SBAS CAT I) designed for 3D instrument approach operations Type A or B.

Note.— Refer to 4.2.8.3 for instrument approach operation types.

Instrument flight rules means a set of rules determined by the Chief Executive Officer to govern flight under conditions in which flight by outside reference cannot be complied with.

Instrument meteorological conditions (IMC) means meteorological conditions expressed in terms of visibility, distance from cloud, and ceiling, which are less than the minima specified for visual meteorological conditions.

Note.— The specified minima for visual meteorological conditions are contained in Chapter 4 of CAD 2.

Isolated aerodrome means a destination aerodrome for which there is no destination alternate aerodrome suitable for a given aeroplane type.

Landing distance available (LDA) means the length of runway which is declared available and suitable for the ground run of an aeroplane landing.

Large aeroplane means an aeroplane of a maximum certificated take-off mass of over 5700 kg.

Low visibility operations means approach operations in RVRs less than 550 m and/or with a DH less than 60 m (200 ft) or take-off operations in RVRs less than 400 m.

Maintenance means in relation an aircraft, the performance of tasks required to ensure the continuing airworthiness of the aircraft, including any one or combination of overhaul, inspection, replacement, defect rectification, and the embodiment of a modification or repair;

Maintenance organisation's procedures manual means a document endorsed by the head of the maintenance organisation which details the maintenance organisation's structure and management responsibilities, scope of work, description of facilities, maintenance procedures and quality assurance or inspection systems.

Maintenance programme means a document which describes the specific scheduled maintenance tasks and their frequency of completion and related procedures, such as a reliability programme, necessary for the safe operation of those aircraft to which it applies.

Maintenance release means a document which contains a certification confirming that the maintenance work to which it relates has been completed in a satisfactory manner either in accordance with the approved data and the procedures described in the maintenance organisation's procedure manual or under an equivalent system.

Master minimum equipment list (MMEL) means a list established for a particular aircraft type by the organisation responsible for the type design with the approval of the State of Design containing items, one or more of which is permitted to be unserviceable at the commencement of a flight. The MMEL may be associated with special operating conditions, limitations or procedures.

Maximum diversion time means maximum allowable range, expressed in time, from a point on a route to an en-route alternate aerodrome.

Maximum mass. Maximum certificated take-off mass.

Minimum descent altitude (MDA) or minimum descent height (MDH) means a specified altitude or height in a two dimensional (2D) instrument approach operation or circling approach operation below which descent must not be made without the required visual reference.

Note 1.— Minimum descent altitude (MDA) is referenced to mean sea level and minimum descent height (MDH) is referenced to the aerodrome elevation or to the threshold elevation if that is more than 2 m (7 ft) below the aerodrome elevation. A minimum descent height for a circling approach is referenced to the aerodrome elevation.

Note 2.— The required visual reference means that section of the visual aids or of the approach area which should have been in view for sufficient time for the pilot to have made an assessment of the aircraft position and rate of change of position, in relation to the desired flight path. In the case of a circling approach the required visual reference is the runway environment.

Note 3.— For convenience when both expressions are used they may be written in the form “minimum descent altitude/ height” and abbreviated “MDA/H”.

Minimum equipment list (MEL) means a list which provides for the operation of aircraft, subject to specified conditions, with particular equipment inoperative, prepared by an operator in conformity with, or more restrictive than, the MMEL established for the aircraft type.

Modification means a change to the type design of an aeronautical product which is not a repair.

Note.— A modification may also include the embodiment of the modification which is a maintenance task subject to a maintenance release. Further guidance on aircraft maintenance — modification and repair is contained in the Airworthiness Manual (ICAO Doc 9760).

Navigation specification means a set of aircraft and flight crew requirements needed to support performance-based navigation operations within a defined airspace. There are two kinds of navigation specifications:

Required navigation performance (RNP) specification. A navigation specification based on area navigation that includes the requirement for performance monitoring and alerting, designated by the prefix RNP, e.g. RNP 4, RNP APCH.

Area navigation (RNAV) specification. A navigation specification based on area navigation that does not include the requirement for performance monitoring and alerting, designated by the prefix RNAV, e.g. RNAV 5, RNAV 1.

Note 1.— The Performance-based Navigation (PBN) Manual (ICAO Doc 9613), Volume II, contains detailed guidance on navigation specifications.

Note 2.— The term RNP, previously defined as “a statement of the navigation performance necessary for operation within a defined airspace”, has been removed from this CAD as the concept of RNP has been overtaken by the concept of PBN. The term RNP in this CAD is now solely used in the context of navigation specifications that require performance monitoring and alerting, e.g. RNP 4 refers to the aircraft and operating requirements, including a 4 NM lateral performance with on-board performance monitoring and alerting that are detailed in ICAO Doc 9613.

Night means the time twenty minutes after sunset and twenty minutes before sunrise, excluding both the times, determined at surface level.

Obstacle clearance altitude (OCA) or obstacle clearance height (OCH) means the lowest altitude or the lowest height above the elevation of the relevant runway threshold or the aerodrome elevation as applicable, used in establishing compliance with appropriate obstacle clearance criteria.

Note 1.— Obstacle clearance altitude is referenced to mean sea level and obstacle clearance height is referenced to the threshold elevation or in the case of non-precision approach procedures to the aerodrome elevation or the threshold elevation if that is more than 2 m (7 ft) below the aerodrome elevation. An obstacle clearance height for a circling approach procedure is referenced to the aerodrome elevation.

Note 2.— For convenience when both expressions are used they may be written in the form “obstacle clearance altitude/ height” and abbreviated “OCA/H”.

Operational control means the exercise of authority over the initiation, continuation, diversion or termination of a flight in the interest of the safety of the aircraft and the regularity and efficiency of the flight.

Operational flight plan means the operator’s plan for the safe conduct of the flight based on considerations of aeroplane performance, other operating limitations and relevant expected conditions on the route to be followed and at the aerodromes concerned.

Operations manual means a manual containing procedures, instructions and guidance for use by operational personnel in the execution of their duties.

Operations specifications means the authorisations, conditions and limitations associated with the air operator certificate and subject to the conditions in the operations manual.

Operator means the person, organisation or enterprise engaged in or offering to engage in an aircraft operation.

Operator’s continuing airworthiness management exposition means a document which describes the operator’s procedures necessary to ensure that all scheduled and unscheduled maintenance is performed on the operator’s aircraft on time and in a controlled and satisfactory manner.

Performance-based communication (PBC) means communication based on performance specifications applied to the provision of air traffic services.

Note.— An RCP specification includes communication performance requirements that are allocated to system components in terms of the communication to be provided and associated transaction time, continuity, availability, integrity, safety and functionality needed for the proposed operation in the context of a particular airspace concept.

Performance-based navigation (PBN) means area navigation based on performance requirements for aircraft operating along an ATS route, on an instrument approach procedure or in a designated airspace.

Note.— Performance requirements are expressed in navigation specifications (RNAV specification, RNP specification) in terms of accuracy, integrity, continuity, availability and functionality needed for the proposed operation in the context of a particular airspace concept.

Performance-based surveillance (PBS) means surveillance based on performance specifications applied to the provision of air traffic services.

Note.— An RSP specification includes surveillance performance requirements that are allocated to system components in terms of the surveillance to be provided and associated data delivery time, continuity, availability, integrity, accuracy of the surveillance data, safety and functionality needed for the proposed operation in the context of a particular airspace concept.

Pilot-in-command means the pilot designated by the operator, or in the case of general aviation, the owner, as being in command and charged with the safe conduct of a flight.

Point of no return means the last possible geographic point at which an aircraft can proceed to the destination aerodrome as well as to an available en-route alternate aerodrome for a given flight.

Pressure-altitude means an atmospheric pressure expressed in terms of altitude which corresponds to that pressure in the Standard Atmosphere.*

Psychoactive substances means alcohol, opioids, cannabinoids, sedatives and hypnotics, cocaine, other psychostimulants, hallucinogens, and volatile solvents, whereas coffee and tobacco are excluded.

Repair means the restoration of an aeronautical product to an airworthy condition as defined by the appropriate airworthiness requirements.

Required communication performance (RCP) specification means a set of requirements for air traffic service provision and associated ground equipment, aircraft capability, and operations needed to support performance-based communication.

Required surveillance performance (RSP) specification means a set of requirements for air traffic service provision and associated ground equipment, aircraft capability, and operations needed to support performance-based surveillance.

Rest period means a continuous and defined period of time, subsequent to and/or prior to duty, during which flight or cabin crew members are free of all duties.

Runway visual range (RVR) means the range over which the pilot of an aircraft on the centre line of a runway can see the runway surface markings or the lights delineating the runway or identifying its centre line.

Safe forced landing means unavoidable landing or ditching with a reasonable expectancy of no injuries to persons in the aircraft or on the surface.

Safety management system (SMS) means a systematic approach to managing safety, including the necessary organisational structures, accountability, responsibilities, policies and procedures.

Small aeroplane means an aeroplane of a maximum certificated take-off mass of 5 700 kg or less.

Specific approval means an approval which is documented in the operations specifications for commercial air transport operations or in the list of specific approvals for general aviation operations.

State of Design means the State having jurisdiction over the organisation responsible for the type design.

State of Registry means the State on whose register the aircraft is entered.

Note.— In the case of the registration of aircraft of an international operating agency on other than a national basis, the States constituting the agency are jointly and severally bound to assume the obligations which, under the Chicago Convention, attach to a State of Registry. See, in this regard, the Council Resolution of 14 December 1967 on Nationality and Registration of Aircraft Operated by International Operating Agencies which can be found in Policy and Guidance Material on the Economic Regulation of International Air Transport (ICAO Doc 9587).

State of the Aerodrome means the State in whose territory the aerodrome is located.

State of the Operator means the State in which the operator's principal place of business is located or, if there is no such place of business, the operator's permanent residence.

Synthetic vision system (SVS) means a system to display data-derived synthetic images of the external scene from the perspective of the flight deck.

Target level of safety (TLS) means a generic term representing the level of risk which is considered acceptable in particular circumstances.

Threshold time means the range, expressed in time, established by the State of the Operator, to an en-route alternate aerodrome, whereby any time beyond requires an EDTO approval from the State of the Operator.

Total vertical error (TVE) means the vertical geometric difference between the actual pressure altitude flown by an aircraft and its assigned pressure altitude (flight level).

Visual meteorological conditions (VMC) means meteorological conditions expressed in terms of visibility, distance from cloud, and ceiling*, equal to or better than specified minima in accordance with visual flight rules

Note.— The specified minima are contained in Chapter 4 of CAD 2.

Visual flight rules means a set of rules determined by the Chief Executive Officer to govern flight under conditions in which outside visual reference can be complied with.

Wet runway means the runway surface is covered by any visible dampness or water up to and including 3 mm deep within the intended area of use.

Abbreviations

%	=	Percent
°C	=	Degrees Celsius
AC	=	Alternating current
ACAS	=	Airborne collision avoidance system
ADRS	=	Aircraft data recording system
ADS	=	Automatic dependent surveillance
ADS-C	=	Automatic dependent surveillance — contract
AEO	=	All engines operative
AFCS	=	Automatic flight control system
AGA	=	Aerodromes, air routes and ground aids
AIG	=	Accident investigation and prevention
AIR	=	Airborne image recorder
AIRS	=	Airborne image recording system
AOC	=	Air operator certificate
AOM	=	Aircraft Operating Manual
APCH	=	Approach
APU	=	Auxiliary power unit
AR	=	Authorisation required
ARINC	=	Aeronautical Radio, Incorporated ASDA
ASDA	=	Accelerate stop distance available
ASE	=	Altimetry system error
ASIA/PAC	=	Asia/Pacific
ATC	=	Air traffic control
ATM	=	Air traffic management
ATN	=	Aeronautical telecommunication network
ATS	=	Air traffic services

CAAM	=	Civil Aviation Authority Malaysia
CAD	=	Civil Aviation Directive
CARS	=	Cockpit audio recording system
CAS	=	Calibrated airspeed
CAT I	=	Category I
CAT II	=	Category II
CAT III	=	Category III
CAT IIIA	=	Category IIIA
CAT IIIB	=	Category IIIB
CAT IIIC	=	Category IIIC
CDL	=	Configuration deviation list
CFIT	=	Controlled flight into terrain
cm	=	Centimetre
COMAT	=	Operator material
CPDLC	=	Controller-pilot data link communications
CVR	=	Cockpit voice recorder
CVS	=	Combined vision system
DA	=	Decision altitude
DA/H	=	Decision altitude/height
DC	=	Direct current
D-FIS	=	Data link-flight information services
DH	=	Decision height
DLR	=	Data link recorder
DLRS	=	Data link recording system
DME	=	Distance measuring equipment
DSTRK	=	Desired track
EDTO	=	Extended diversion time operations
EFB	=	Electronic flight bag
EFIS	=	Electronic flight instrument system
EGT	=	Exhaust gas temperature
ELT	=	Emergency locator transmitter
ELT(AD)	=	Automatic deployable ELT
ELT(AF)	=	Automatic fixed ELT
ELT(AP)	=	Automatic portable ELT
ELT(S)	=	Survival ELT
EPR	=	Engine pressure ratio
EUROCAE	=	European Organisation for Civil Aviation Equipment EVS
EVS	=	Enhanced vision system
FANS	=	Future air navigation system
FDAP	=	Flight data analysis programmes
FDR	=	Flight data recorder
FL	=	Flight level
FM	=	Frequency modulation
ft	=	Foot
ft/min	=	Feet per minute
g	=	Normal acceleration
GCAS	=	Ground collision avoidance system
GNSS	=	Global navigation satellite system

GPWS	=	Ground proximity warning system
hPa	=	Hectopascal
HUD	=	Head-up display
IFR	=	Instrument flight rules
ILS	=	Instrument landing system
IMC	=	Instrument meteorological conditions
inHg	=	Inch of mercury
INS	=	Inertial navigation system
ISA	=	International standard atmosphere
kg	=	Kilogram
kg/m ²	=	Kilogram per metre squared
km	=	Kilometre
km/h	=	Kilometre per hour
kt	=	Knot
kt/s	=	Knots per second
lb	=	Pound
lbf	=	Pound-force
LDA	=	Landing distance available
LED	=	Light emitting diode
m	=	Metre
m/s	=	Metres per second
m/s ²	=	Metres per second squared
mb	=	Millibar
MCAI	=	Mandatory Continuing Airworthiness Information
MDA	=	Minimum descent altitude
MDA/H	=	Minimum descent altitude/height
MDH	=	Minimum descent height
MEL	=	Minimum equipment list
MHz	=	Megahertz
MLS	=	Microwave landing system
MMEL	=	Master minimum equipment list
MNPS	=	Minimum navigation performance specification
MOPS	=	Minimum operational performance specification
N	=	Newton
N ₁	=	Low pressure compressor speed (two-stage compressor); fan speed (three-stage compressor)
N ₂	=	High pressure compressor speed (two-stage compressor); intermediate pressure compressor speed (three-stage compressor)
N ₃	=	High pressure compressor speed (three stage compressor)
NAV	=	Navigation
NM	=	Nautical mile
NVIS	=	Night vision imaging systems
OCA	=	Obstacle clearance altitude
OCA/H	=	Obstacle clearance altitude/height
OCH	=	Obstacle clearance height
OEI	=	One engine inoperative
PANS	=	Procedures for Air Navigation Services
PBC	=	Performance-based communication



PBN	=	Performance-based navigation
PBS	=	Performance-based surveillance
PDP	=	Predetermined point
RCF	=	Reduced Contingency Fuel
RCP	=	Required communication performance
RNAV	=	Area navigation
RNP	=	Required navigation performance
RSP	=	Required surveillance performance
RTCA	=	Radio Technical Commission for Aeronautics
RVR	=	Runway visual range
RVSM	=	Reduced vertical separation minima
SIP	=	Structural Integrity Programme
SOP	=	Standard operating procedure
SST	=	Supersonic transport
STOL	=	Short take-off and landing
SVS	=	Synthetic vision system
TAS	=	True airspeed
TAWS	=	Terrain awareness warning system
TCAS	=	Traffic alert and collision avoidance system TLA
T.I	=	Technical Instructions
TLA	=	Thrust lever angle
TLS	=	Target level of safety
TSO	=	Technical standard orders
TVE	=	Total vertical error
UTC	=	Coordinated universal time
V_D	=	Design diving speed
VFR	=	Visual flight rules
VMC	=	Visual meteorological conditions
V_{MC}	=	Minimum control speed with the critical engine inoperative VOR
VOR	=	VHF omnidirectional radio range
V_s	=	Stalling speed or the minimum steady flight speed in a specified configuration
V_{s0}	=	Stalling speed or the minimum steady flight speed in the landing configuration.
VTOL	=	Vertical take-off and landing
WXR	=	Weather



INTENTIONALLY LEFT BLANK

2 References

1. MCAR 2016
2. International Civil Aviation Organisation (ICAO).
 - (i) Doc 9318 (Article 83Bis)
 - (ii) Doc 4444, Doc 9868 (PAN-TRG)
 - (iii) Doc 9481 (ERP on DG)
 - (iv) Doc 9683 (Human Factor)
 - (v) Doc 9640 (Manual De-icing)
 - (vi) Doc 9365 (AWO)
 - (vii) Doc 8335 (Inspection Manual)
 - (viii) Doc 9379 (Licensing System)
 - (ix) Doc 9376 (Ops Manual)
 - (x) Doc 9966 (Fatigue Management)
 - (xi) Doc 10002 (Cabin Crew Safety Training Manual)
 - (xii) Doc 8168 – PANS Aircraft Operations
3. Annex 8 – Airworthiness
4. Air Navigation (98-Special Operations) Regulation 2018
5. EASA Ops 2016
6. Air Navigation (98 – Special Operations) Regulation 2018.
7. Other documents
 - (i) CAD 6004 - Air Operator Certificate (AOC)
 - (ii) CAGM 6008 - Special Approval (SPA)
 - Part I - Reduce Vertical Separation Minima (RVSM)
 - Part II - Performance Based Navigation (PBN)
 - Part III - Low Visibility Operations (LVO)
 - Part IV - Extended Diversion Time Operations (EDTO)
 - Part V - Electronic Flight Bag (EFB)
 - Part VI – NAT HLA, PBCS, CPDLC & ADS
 - (iii) CAD 6010 - Ground Handling (GH)



INTENTIONALLY LEFT BLANK

3 General Requirements

3.1 Compliance with laws, regulations and procedures

3.1.1 Laws, Regulations and Procedures – Operator’s Responsibilities.

3.1.1.1 An operator shall ensure that all its employees are made aware that they shall comply with the laws, regulations and procedures of those States in which operations are conducted and which are pertinent to the performance of their duties.

3.1.2 Laws, Regulations and Procedures – Crew Members’ Responsibilities.

3.1.2.1 The pilot-in-command shall comply with the laws, regulations and procedures of those States where operations are conducted.

3.1.2.2 The pilot-in-command shall be familiar with the laws, regulations and procedures, pertinent to the performance of his duties, prescribed for the areas to be traversed, the aerodromes to be used and the related air navigation facilities.

3.1.2.3 All crew members shall be familiar with the laws, regulations and procedures pertinent to the performance of their duties.

3.1.3 An operator shall:

3.1.3.1 Establish and maintain a method of exercising operational control approved by the CAAM; and

3.1.3.2 Exercise operational control over any flight operated under the terms of his AOC/Authorisation.

3.1.4 The operator shall ensure that the responsibility for operational control is delegated only to the Pilot-In-Command, and to a flight operations officer/flight dispatcher, if applicable.

3.1.5 Because of the nature and extent of the duties and responsibilities involved in the supervision of flight operations, the operator shall implement an approved method of control and supervision of flight operations requiring the services of a flight operations officer/flight dispatcher.

3.1.5.1 The operator shall ensure that the flight operations officer/flight dispatcher is assigned to duty in the company operations control centre and is responsible, while on duty, for carrying out the operational control procedures and policies specified in the Operations Manual.

3.1.5.2 The flight operations officer/flight dispatcher must have proof of qualifications and meet the requirements specified in CAD 1.

- 3.1.6 In the event of an emergency, a flight operations officer/flight dispatcher shall:
- 3.1.6.1 Initiate such procedures as outlined in the operations manual while avoiding taking any action that would conflict with ATC procedures; and
 - 3.1.6.2 Convey safety-related information to the pilot-in-command that may be necessary for the safe conduct of the flight, including information related to any amendments to the flight plan that become necessary in the course of the flight
 - 3.1.6.3 Where necessary, inform the appropriate authorities and the CAAM of the nature of the situation without delay, and requests for assistance if required.
- 3.1.7 An operator shall establish procedures for reporting accidents and serious incidents taking into account responsibilities as described below.
- 3.1.7.1 The operator shall ensure that the pilot-in-command notify the operator of any accident or serious incident occurring while he was responsible for the flight.
 - 3.1.7.2 In the event that the pilot-in-command is incapable of providing such notification, this task shall be undertaken by any other member of the crew if they are able to do so, note being taken of the succession of command specified by the operator.
 - 3.1.7.3 The operator shall ensure that the pilot-in-command notify the CAAM, the nearest appropriate Authority and any other organisation required by the CAAM to be informed, by the quickest means available of any accident or serious incident and - in the case of accidents only - at least before the aeroplane is moved unless exceptional circumstances prevent this.
- 3.1.8 Search and rescue information.
- 3.1.8.1 An operator shall ensure that essential information pertinent to the intended flight concerning search and rescue services is easily accessible on the flight deck.
- 3.2 Compliance by a foreign operator with laws, regulations and procedures of Malaysia**
- 3.2.1 All foreign operators operating in the territory and airspace (Flight Information Region (FIR)) of Malaysia shall be subject to safety oversight by the CAAM.
 - 3.2.1.1 A foreign operator that intends to operate commercial flights into Malaysia must first be registered and be issued with a Foreign Air Operator Certificate (FAOC). An application for initial registration as a Foreign Operator must be submitted no later than 90 days prior to the intended commencement of operations into Malaysia. The FAOC shall remain valid for a period of one (1) year. The foreign operator shall submit an application for renewal of FAOC no

later than 30 days prior to the expiry of the current registration. Variation(s) to an FAOC shall be made withing 14 days from the date of amendment of the foreign AOC.

3.2.1.2 When conducting operations into Malaysia, the obligations of the Foreign Operators include the following:

- a) Compliance with the Laws of Malaysia and applicable publications such as the MCAR, related provisions of CADs, Malaysian AIP, Safety Alerts and Notices.
- b) Granting Inspectors from the CAAM permission to board an aircraft without notice to undertake review of relevant licence and authorisation carried on-board and to carry out a ramp inspection.
- c) Reporting to the CAAM any air safety incident or occurrence which arises within the Malaysian FIR.
- d) Carrying on-board the aircraft copies of the AOC, the Operations Specificatisons with a valid insurance certificate and meeting the minimum requirements as set out in ICAO Annex 1, 6, 8, 13, 17, 18 and 19.
- e) For aircraft operating above the transition altitude within the Malaysian FIR, it must be equipped with RNAV equipment meeting RNAV 5 requirements.
- f) For aircraft with a MTOW exceeding 5,700 kg or more and which can carry more than 19 passengers, it must be equipped with ACAS II equipment and a mode S transponder; and
- g) All aircraft undertaking IFR flights within the Malaysian FIR must be equipped with an Automatic Dependent Surveillance - Broadcast Out equipment (ADS-B).
- h) Comply with the FAOC issued by the CAAM and terms and conditions attached.
- i) Notify the CAAM of lease arrangements not more than 72 hours prior to the lease arrangement if the FAOC holder intends to enter into any lease arrangements.

3.2.1.3 Ramp inspections.

3.2.1.3.1 In respect of ramp inspection of foreign operated aircraft, if the CAAM has any findings, the CAAM may request corrective actions to be undertaken by the operator. Depending on the severity of the finding, the CAAM has the right to restrict the operations of the aircraft, ground the aircraft and/or ban the operations.

3.2.1.4 Crew members of Foreign Operators.

- 3.2.1.4.1 All foreign operators shall ensure that their crew members are not performing duties under the influence of alcohol or under the influence of any substance which may impair their capacity to perform their duties.
- 3.2.1.4.2 All crew members may be subject to testing for "psychoactive substances" whilst on duty and if a positive test is returned or a crew member refuses to submit to a test, the CAAM may impose a range of sanctions including grounding the aircraft or prosecution.
- 3.2.1.5 CAAM approvals are required for activities involving foreign registered aircraft in the territory and airspace of Malaysia.
- 3.2.2 When CAAM identifies a case of non-compliance or suspected non-compliance by a foreign operator with laws, regulations and procedures applicable within Malaysia, or a similar serious safety issue with that operator, the CAAM will immediately notify the operator and, if the issue warrants it, the State of the Operator. Where the State of the Operator and the State of Registry are different, such notification shall also be made to the State of Registry, if the issue falls within the responsibilities of that State and warrants a notification.
- 3.2.3 In the case of notification to States as specified in Paragraph 3.3.2, if the issue and its resolution warrant it, the CAAM will engage in consultations with the State of the Operator and the State of Registry, as applicable, concerning the safety standards maintained by the operator.

Note. – Guidance for the application and renewal of the FAOC can be found in CAGM 6005.

3.3 Safety management

Note1. – For Flight Data Analysis Programme (FDAP), refer to CAGM 6004.

Note 2.— CAD 19 includes safety management provisions for air operators. Further guidance is contained in the Safety Management Manual (SMM) (ICAO Doc 9859).

- 3.3.1 The operator of an aeroplane of a certificated take-off mass in excess of 20 000 kg should establish and maintain a flight data analysis programme as part of its safety management system.
- 3.3.2 The operator of an aeroplane of a maximum certificated take-off mass in excess of 27 000 kg shall establish and maintain a flight data analysis programme as part of its safety management system.
- Note.— The operator may contract the operation of a flight data analysis programme to another party while retaining overall responsibility for the maintenance of such a programme.*
- 3.3.3 A flight data analysis programme shall contain adequate safeguards to protect the source(s) of the data in accordance with Appendix 3 to CAD 19.

- 3.3.4 CAAM does not allow the use of recordings or transcripts of CVR, CARS, Class A AIR and Class A AIRS for purposes other than the investigation of an accident or incident, except where the recordings or transcripts are:
- related to a safety-related event identified in the context of a safety management system; are restricted to the relevant portions of a de-identified transcript of the recording; and are subject to the protections accorded by CAD 19;
 - sought for use in criminal proceedings not related to an event involving an accident or incident investigation and are subject to the protections accorded by CAD 19; or
 - used for inspections of flight recorder systems as provided in Section 7 of Appendix 8, Chapter 16.8.
- 3.3.5 CAAM does not allow the use of recordings or transcripts of FDR, ADRS as well as Class B and Class C AIR and AIRS for purposes other than the investigation of an accident or incident, except where the recordings or transcripts are subject to the protections accorded by CAD 19 and are:
- used by the operator for airworthiness or maintenance purposes;
 - used by the operator in the operation of a flight data analysis programme required in this CAD;
 - sought for use in proceedings not related to an event involving an accident or incident investigation;
 - de-identified; or
 - disclosed under secure procedures.
- 3.3.6 The operator shall establish a flight safety documents system, for the use and guidance of operational personnel, as part of its safety management system.

Note.— Guidance on the development and organisation of a flight safety documents system is provided in Attachment F of this CAD.

3.4 Use of psychoactive substances

- 3.4.1 No person whose function is critical to the safety of aviation (safety-sensitive personnel) shall undertake that function while under the influence of any psychoactive substance, by reason of which human performance is impaired. No such person shall engage in any kind of problematic use of substances. Provisions concerning the use of psychoactive substances are also contained in CAD 1 - 1.2.7.

Note. – For provisions concerning the use of psychoactive substances, refer to CAD 1, 1.2.7 and CAD 2, 2.5.

3.5 Aircraft tracking

3.5.1 The operator shall establish an aircraft tracking capability to track aeroplanes throughout its area of operations.

Note.— Guidance on aircraft tracking capabilities is contained in the Aircraft Tracking Implementation Guidelines (ICAO Cir 347).

3.5.2 The operator shall track the position of an aeroplane through automated reporting at least every 15 minutes for the portion(s) of the in-flight operation(s) under the following conditions:

- a) the aeroplane has a maximum certificated take-off mass of over 27 000 kg and a maximum approved passenger seating configuration greater than 19; and
- b) where an ATS unit obtains aeroplane position information at greater than 15 minute intervals.

Note.— See CAD 11, Chapter 2, for coordination between the operator and air traffic services providers regarding position report messages.;

3.5.3 The operator shall track the position of an aeroplane through automated reporting at least every 15 minutes for the portion(s) of the in-flight operation(s) that is planned in an oceanic area(s) under the following conditions:

- a) the aeroplane has a maximum certificated take-off mass of over 45 500 kg and a maximum approved passenger seating configuration greater than 19; and
- b) where an ATS unit obtains aeroplane position information at greater than 15 minute intervals.

Note 1.— Oceanic area, for the purpose of aircraft tracking, is the airspace which overlies waters outside the territory of a State.

Note 2.— See CAD 11, Chapter 2, for coordination between the operator and air traffic services providers regarding position report messages.

3.5.4 Notwithstanding the provisions in 3.5.2 and 3.5.3, CAAM may, based on the results of an approved risk assessment process implemented by the operator, allow for variations to automated reporting intervals. The process shall demonstrate how risks to the operation, resulting from such variations, can be managed and shall include at least the following:

- a) capability of the operator's operational control systems and processes, including those for contacting ATS units;
- b) overall capability of the aeroplane and its systems;
- c) available means to determine the position of, and communicate with, the aeroplane;

- d) frequency and duration of gaps in automated reporting;
- e) human factors consequences resulting from changes to flight crew procedures; and
- f) specific mitigation measures and contingency procedures.

Note.— Guidance on development, implementation and approval of the risk assessment process, which allows for variations to the need for automatic reporting and the required interval, including variation examples, is contained in the Aircraft Tracking Implementation Guidelines (ICAO Cir 347).

- 3.5.5 The operator shall establish procedures, approved by CAAM, for the retention of aircraft tracking data to assist SAR in determining the last known position of the aircraft

Note.— Refer to 4.2.1.3.1 for operator responsibilities when using third parties for the conduct of aircraft tracking under 3.5.



INTENTIONALLY LEFT BLANK

4 Flight Operations

4.1 Operating facilities

4.1.1 The operator shall ensure that a flight will not be commenced unless it has been ascertained by every reasonable means available that the ground and/or water facilities available and directly required on such flight, for the safe operation of the aeroplane and the protection of the passengers, are adequate for the type of operation under which the flight is to be conducted and are adequately operated for this purpose.

4.1.2 The operator shall ensure that a flight will not commence or continue as planned unless it has been ascertained by every reasonable means available that the airspace containing the intended route from aerodrome of departure to aerodrome of arrival, including the intended take-off, destination and en-route alternate aerodromes, can be safely used for the planned operation. When intending to operate over or near conflict zones, a risk assessment shall be conducted and appropriate risk mitigation measures taken to ensure a safe flight.

Note.— “Reasonable means” is intended to denote the use, at the point of departure or while the aircraft is in flight, of information available to the operator either through official information published by the aeronautical information services or readily obtainable from other sources.

4.1.3 The operator shall ensure that any inadequacy of facilities observed in the course of operations is reported to the CAAM, without undue delay.

4.1.4 Subject to their published conditions of use, the aerodromes where the operators facilities are based, shall be kept continuously available for flight operations during the aerodromes published hours of operations, irrespective of weather conditions.

4.1.5 The operator shall, as part of its SMS, assess the level of rescue and firefighting service (RFFS) protection available at any aerodrome intended to be specified in the operational flight plan in order to ensure that an acceptable level of protection is available for the aeroplane intended to be used.

Note. – CAD 19 includes safety management provisions for air operators. Further guidance is contained in the ICAO Safety Management Manual (SMM) (ICAO Doc 9859).

4.1.6 The operator shall ensure that Information related to RFFS (Rescue and Fire Fighting Services) protection is described in the operators Operations Manual for aerodrome information against aircraft Fire Fighting required.

4.1.6.1 When defining aerodromes for the type of aeroplane(s) and operation(s) concerned, an operator shall take into account of the following:

- a) An adequate aerodrome is an aerodrome which the operator considers to be satisfactory, taking account of the applicable performance requirements and runway characteristics.
- b) In addition, it shall be anticipated that, at the expected time of use, the aerodrome will be available and equipped with necessary ancillary services, such as ATS, sufficient lighting, communications, weather reporting, nav-aids and emergency services / Rescue and Fire Fighting Services.

Note 1. – Attachment I of this CAD contains guidance on assessing an acceptable level of RFFS protection at aerodromes.

Note 2. – It is not intended that this guidance limit or regulate the operation of an aerodrome. The assessment performed by the operator does not in any way affect the RFFS requirements of CAD 14, Volume I, for aerodromes.

4.2 Operational certification and supervision

4.2.1 The air operator certificate

4.2.1.1 The operator shall not engage in commercial air transport operations unless in possession of a valid air operator certificate issued by the CAAM.

4.2.1.2 The air operator certificate shall authorise the operator to conduct commercial air transport operations in accordance with the operations specifications.

Note.— Provisions for the content of the air operator certificate and its associated operations specifications are contained in 4.2.1.5 and 4.2.1.6.

4.2.1.3 The issue of an air operator certificate by the CAAM shall be dependent upon the operator demonstrating an adequate organisation, method of control and supervision of flight operations, training programme as well as ground handling and maintenance arrangements consistent with the nature and extent of the operations specified.

Note.— Attachment D contains guidance on the issue of an air operator certificate.

4.2.1.3.1 The operator shall develop policies and procedures for third parties that perform work on its behalf.

4.2.1.4 The continued validity of an air operator certificate shall depend upon the operator maintaining the requirements of 4.2.1.3 under the supervision of the CAAM.

4.2.1.5 The air operator certificate shall contain at least the following information and shall follow the layout of Appendix 6, paragraph 2:

- a) Malaysia as the State of the Operator and the CAAM as the issuing authority;

- b) the air operator certificate number and its expiration date;
- c) the operator name, trading name (if different) and address of the principal place of business;
- d) the date of issue and the name, signature and title of the authority representative; and
- e) the location, in a controlled document carried on board, where the contact details of operational management can be found.

4.2.1.6 The operations specifications associated with the air operator certificate shall contain at least the information listed in Appendix 6, paragraph 3, and shall follow the layout of Appendix 6, paragraph 3.

Note.— Attachment D, paragraph 3.2.2, contains additional information that may be listed in the operations specifications associated with the air operator certificate.

4.2.1.7 Air operator certificates and their associated operations specifications first issued from 20 November 2008 shall follow the layouts of Appendix 6, paragraphs 2 and 3.

4.2.2 Surveillance of operations by a foreign operator

4.2.2.1 CAAM recognises an air operator certificate issued by another Contracting State, provided that the requirements under which the certificate was issued are at least equal to the applicable Standards specified in this Annex 6 Part 1 and Annex 19.

4.2.2.2 The operator shall meet and maintain the requirements established by the States in which the operations are conducted.

Note.— Guidance on the surveillance of operations by foreign operators may be found in the Manual of Procedures for Operations Inspection, Certification and Continued Surveillance (Doc 8335).

4.2.3 Operations Manual

4.2.3.1 An operator shall provide an Operations Manual (OM) for the use and guidance of its operations personnel.

4.2.3.2 General Rules for OM.

- a) An operator shall ensure that the OM contains all instructions and information necessary for operations personnel to perform their duties.
- b) An operator shall ensure that the contents of the OM, including all amendments or revisions, do not contravene the conditions contained in the Air Operator Certificate (AOC) or any applicable regulations and are acceptable to, or, where applicable, approved by, the CAAM.

- c) Unless otherwise approved by the CAAM, an operator must prepare the OM in the English language. In addition, an operator may translate and use that manual, or parts thereof, into another language.
- d) Should it become necessary for an operator to produce new OMs or major parts/volumes thereof, he must comply with the provision in subparagraph (c) above.
- e) An operator may issue an OM in separate volumes.
- f) An operator shall ensure that all operations personnel have easy access to a copy of each part of the OM which is relevant to their duties.
- g) In addition, the operator shall supply crew members with a personal copy of, or sections from, Parts A and B of the OM as are relevant for personal study.
- h) An operator shall ensure that the OM is amended or revised so that the instructions and information contained therein are kept up to date.
- i) The operator shall ensure that all operations personnel are made aware of such changes that are relevant to their duties. Approval, acceptance or notification to CAAM is required as appropriate, prior to making any changes to the manual.
- j) Each holder of an OM, or appropriate parts of it, shall keep it up to date with the amendments or revisions supplied by the operator.
- k) An operator shall supply the CAAM with intended amendments and revisions in advance of the effective date for approval or acceptance by the CAAM.
- l) When the amendment concerns any part of the OM which must be approved in accordance with this CAD, this approval shall be obtained before the amendment becomes effective.
- m) When immediate amendments or revisions are required in the interest of safety, they may be published and applied immediately, provided that any approval required has been applied for.
- n) An operator shall incorporate all amendments and revisions required by the CAAM.
- o) An operator must ensure that information taken from approved documents, and any amendment of such approved documentation, is correctly reflected in the OM and that the OM contains no information contrary to any approved documentation. However, this requirement does not prevent an operator from using more conservative data and procedures.

- p) An operator must ensure that the contents of the OM are presented in a form in which they can be used without difficulty. The design of the OM shall observe Human Factors principles.
- q) An operator may be permitted by the CAAM to present the OM or parts thereof in a form other than on printed paper. In such cases, an acceptable level of accessibility, usability and reliability must be assured.
- r) The use of an abridged form of the OM does not exempt the operator from the following requirements:
 - 1) That the current parts of the OM relevant to the duties of the crew are carried on each flight.
 - 2) Those parts of the OM which are required for the conduct of a flight are easily accessible to the crew on board the aeroplane.
 - 3) The current Aeroplane Flight Manual is carried in the aeroplane unless the CAAM has accepted that the OM contains relevant information for that aeroplane.

4.2.3.3 Information in the Operator's OM must be presented in clear unambiguous English text and/or graphics in a readily amendable format. The applicant shall ensure that the structure of the OM consists of the following parts.

- a) Part A General/Basic.
- b) Part B Aircraft Operating matters
- c) Part C Route and Aerodrome Instruction and Information
- d) Part D Training.

4.2.3.4 Appendix 2 to this CAD contains a comprehensive detailed and structured list of all items to be covered in the OM. The contents of the manual are subject to the CAAM assessment and the elements/subjects that require specific approvals or acceptance by the CAAM.

Note. – Specific items in the OM require the approval of the CAAM in accordance with the Standards in 4.2.8, 6.1.3, 9.3.1, 12.4 and 13.4.1. of CAD 6 Part 1.

4.2.4 Operating Instructions – General

4.2.4.1 An operator shall ensure that all personnel assigned to, or directly involved in, ground and flight operations are properly instructed, have demonstrated their abilities in their particular duties and are aware of their responsibilities and the relationship of such duties to the operation as a whole.

4.2.4.2 An operator shall take all reasonable steps to ensure that an aeroplane in his charge is not taxed on the movement and manoeuvring area of an aerodrome

by a person other than a flight crew member, unless that person, seated at the controls:

- a) Has been duly authorised by the operator or a designated agent and is competent to:
 - 1) taxi the aeroplane.
 - 2) use the radio telephone.
- b) Has received instruction in respect of aerodrome layout, routes, signs, marking, lights, air traffic control signals and instructions, phraseology and procedures, and is able to conform to the operational standards required for safe aeroplane movement at the aerodrome.

4.2.4.3 An operator shall also ensure that its pilots who are required to use the radio telephone aboard an aircraft shall demonstrate the ability to speak and understand the English language as used for radiotelephony communications.

Note. – Refer CAD 107 ELPT for further details.

4.2.4.4 An operator should issue operating instructions and provide information on aeroplane climb performance with all engines operating to enable the pilot-in-command to determine the climb gradient that can be achieved during the departure phase for the existing take-off conditions and intended take-off technique. This information should be included in the OM.

4.2.4.5 Pushback and towing procedures specified by the operator shall be conducted in accordance with established aviation standards and procedures.

4.2.5 In-flight simulation of emergency situations

4.2.5.1 An operator shall establish procedures to ensure that abnormal or emergency situations requiring the application of part or all of abnormal or emergency procedures and simulation of IMC by artificial means, are not simulated during commercial air transportation flights.

4.2.5.2 These procedures shall be included in the Operations Manual Part D – Training.

4.2.6 Checklists

4.2.6.1 An operator shall establish checklists as an integral part of SOPs. The checklists shall describe the actions relevant to specific phases of operations (engine start, taxi, take off, etc) that flight crew must perform or verify and which relate to flight safety.

4.2.6.2 The checklists shall also provide a framework for verifying aircraft and systems configuration that guard against vulnerabilities in human performance.

- 4.2.6.3 The checklists shall be used by flight crew prior to, during and after all phases of operations, and in emergency, to ensure compliance with the operating procedures contained in the aircraft operating manual and the aeroplane flight manual or other documents associated with the certificate of airworthiness and otherwise in the OM, are followed.
- 4.2.6.4 The design and utilisation of checklists shall observe Human Factors principles. These documents shall be part of the operator's OM Part B or separate document that shall be listed in OM part A specific to each aeroplane type.
- 4.2.6.5 The checklist is a document that provide guidance to flight operations personnel to ensure safe, efficient logical and predictable means of carrying out flight procedures. To achieve these objectives, checklists shall unambiguously express:
- a) what the task is.
 - b) when the task is going to be conducted (time and sequence)
 - c) by whom the task is going to be conducted
 - d) how the task is going to be done (actions)
 - e) what the sequence of actions consists of
 - f) what type of feedback is to be provided as a result of the actions (verbal call-outs, instrument indications, switch positions and etc).

Note. – Guidance material on the application of Human Factors principles can be found in the Human Factors Training Manual (ICAO Doc 9683).

4.2.7 Minimum Flight Altitudes

- 4.2.7.1 An operator shall establish minimum flight altitudes for those routes flown for which minimum flight altitudes have been established by the State flown over or the responsible State, provided that they shall not be less than those established by that State, and shall include this method in the Operations manual.
- 4.2.7.2 In establishing Minimum Flight Altitudes, the operator may adopt the following methods available for calculating minimum flight altitudes.
- a) KSS Formula.
 - 1) Minimum obstacle clearance altitude (MOCA). MOCA is the sum of:
 - i) The maximum terrain or obstacle elevation whichever is highest; plus
 - ii) 1000 ft for elevation up to and including 6000 ft; or

- iii) 2000 ft for elevation exceeding 6000 ft rounded up to the next 100 ft.
- 2) The lowest MOCA to be indicated is 2000 ft.
- 3) From a VOR station, the corridor width is defined as a borderline starting 5 nm either side of the VOR, diverging 4° from centreline until a width of 20 nm is reached at 70 nm out, thence paralleling the centreline until 140 nm out, thence again diverging 4° until a maximum width of 40 nm is reached at 280 nm out. Thereafter the width remains constant (see figure 1).

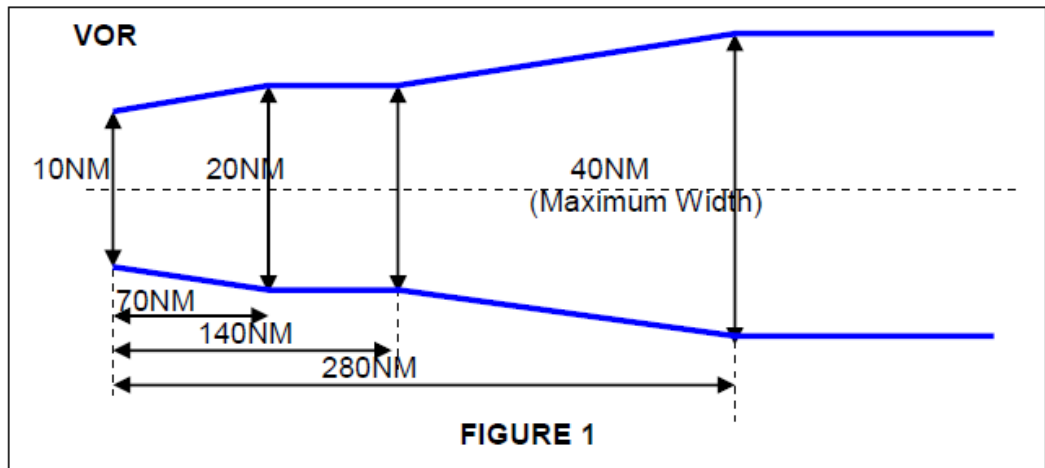

- 4) From an NDB, similarly, the corridor width is defined as a borderline starting 5 nm either side of the NDB diverging 7° until a width of 20 nm is reached 40 nm out, thence paralleling the centreline until 80 nm out, thence again diverging 7° until a maximum width of 60 nm is reached 245 nm out. Thereafter the width remains constant (see figure 2).

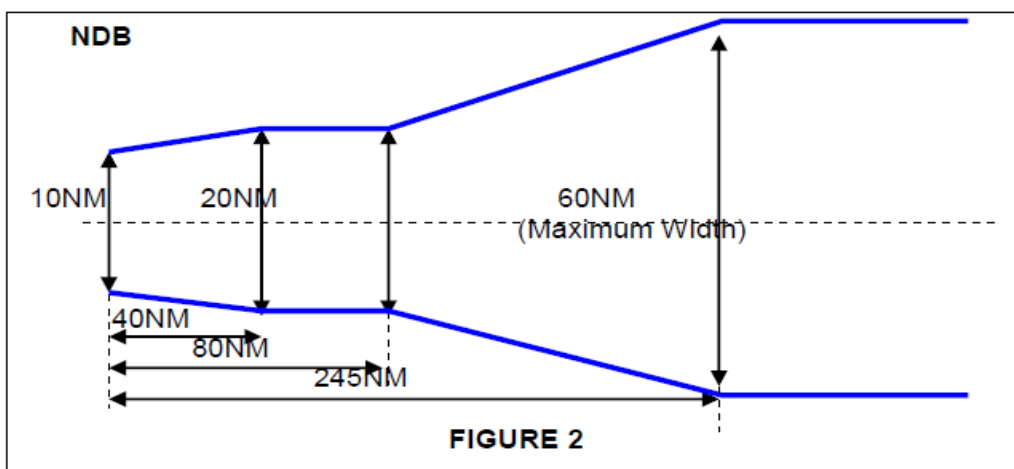

- 5) MOCA does not cover any overlapping of the corridor.

- i) Minimum off-route altitude (MORA). MORA is calculated for an area bounded by every or every second LAT/LONG square on the Route Facility Chart (RFC)/Terminal Approach Chart (TAC) and is based on a terrain clearance as follows:
 - (aa) Terrain with elevation up to 6000 ft (2000 m) – 1000 ft above the highest terrain and obstructions.
 - (bb) Terrain with elevation above 6000 ft (2000 m) – 2000 ft above the highest terrain and obstructions.

- b) Jeppesen Formula (see figure 3).
 - 1) MORA is a minimum flight altitude computed by Jeppesen from current ONC or WAC charts. Two types of MORAs are charted which are:
 - i) Route MORAs e.g. 9800a; and
 - ii) Grid MORAs e.g. 98.
 - 2) Route MORA values are computed on the basis of an area extending 10 nm to either side of route centreline and including a 10 nm radius beyond the radio fix/reporting point or mileage break defining the route segment.
 - 3) MORA values clear all terrain and man-made obstacles by 1000 ft in areas where the highest terrain elevation or obstacles are up to 5000 ft. A clearance of 2000 ft is provided above all terrain or obstacles which are 5 001 ft and above.
 - 4) A Grid MORA is an altitude computed by Jeppesen and the values are shown within each Grid formed by charted lines of latitude and longitude. Figures are shown in thousands and hundreds of feet (omitting the last two digits so as to avoid chart congestion). Values followed by ± are believed not to exceed the altitudes shown.

Figure 3

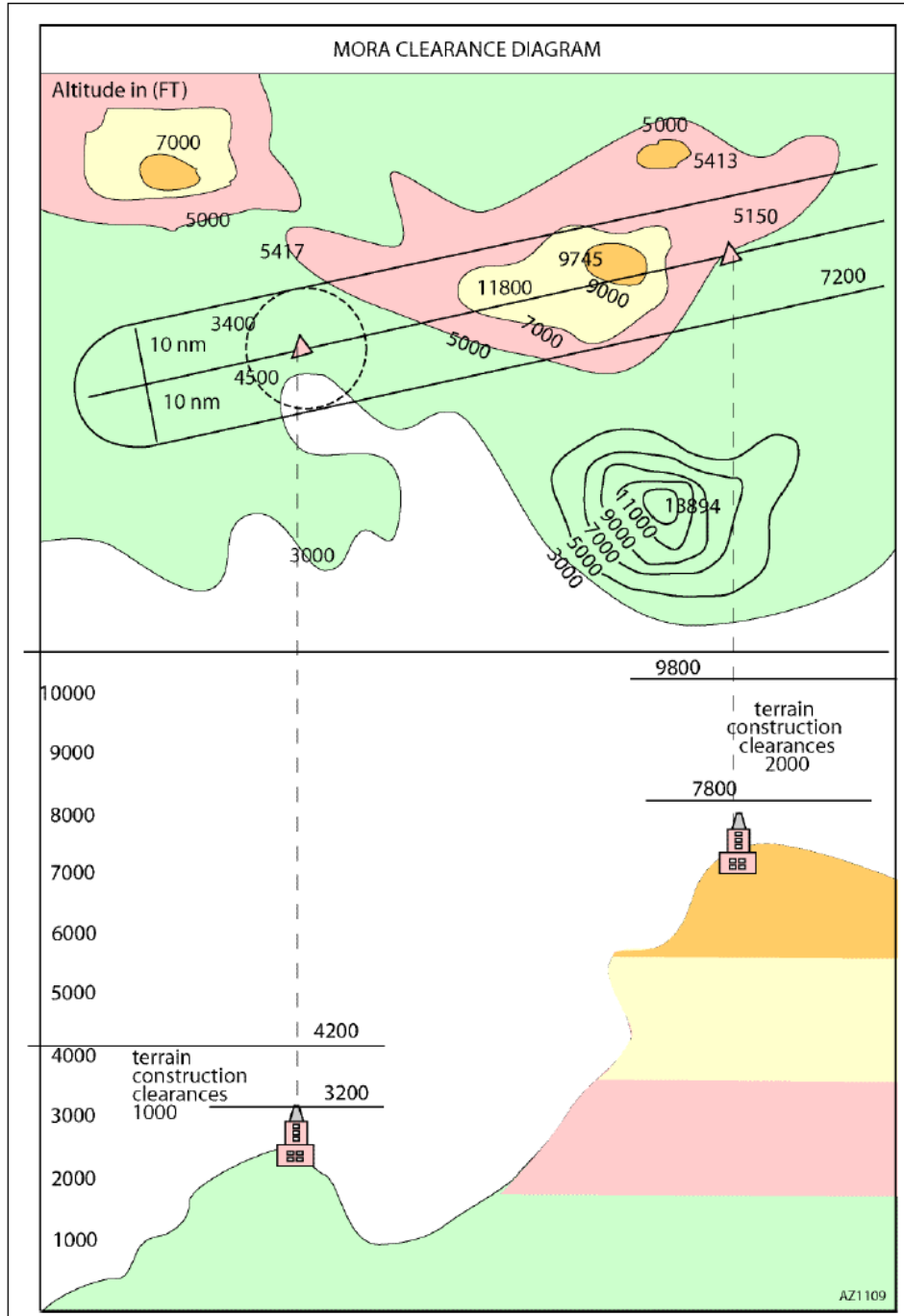

c) LIDO Formula.

1) Minimum terrain clearance altitude (MTCA)

The MTCA represents an altitude providing terrain and obstacle clearance for all airways/ATS routes, all standard terminal arrival

route (STAR) segments up to IAF or equivalent end point and selected standard instrument departures (SIDs).

The MTCA is calculated by Lido and covers terrain and obstacle clearance relevant for air navigation with the following buffers:

- i) Horizontal
 - (A) for SID and STAR procedures 5NM either side of centre line; and
 - (B) for airways/ATS routes 10 NM either side of centre line.
- ii) Vertical:
 - (A) 1000 ft up to 6000 ft; and
 - (B) 2000 ft above 6000 ft.

MTCAs are always shown in feet. The lowest indicated MTCA is 3100 ft.

2) Minimum grid altitude (MGA)

MGA represents the lowest safe altitude which can be flown off-track. The MGA is calculated by rounding up the elevation of the highest obstruction within the respective grid area to the next 100 ft and adding an increment of

- i) 1000 ft for terrain or obstructions up to 6000 ft; and
- ii) 2000 ft for terrain or obstructions above 6000 ft.

MGA is shown in hundreds of feet. The lowest indicated MGA is 2000 ft. This value is also provided for terrain and obstacles that would result in an MGA below 2000 ft. An exception is over water areas where the MGA can be omitted.

d) ATLAS Formula.

1) Minimum safe En-route Altitude (MEA). Calculation of the MEA is based on the elevation of the highest point along the route segment concerned (extending from navigational aid to navigational aid) within a distance on either side of track as specified below:

- i) Segment length up to 100 nm –10 nm (See Note 1 below).
- ii) Segment length more than 100 nm –10% of the segment length up to a maximum of 60 nm See Note 2 below).

Note 1: This distance may be reduced to 5 nm within TMAs where, due to the number and type of available navigational aids, a high degree of navigational accuracy is warranted.

Note 2: In exceptional cases, where this calculation results in an operationally impracticable value, an additional special MEA may be calculated based on a distance of not less than 10 nm either side of track.

Such special MEA will be shown together with an indication of the actual width of protected airspace.

- 2) The MEA is calculated by adding an increment to the elevation specified above as appropriate:

Elevation of highest point	Increment
Not above 5000 ft	1500 ft
Above 5000 ft but not above 10000 ft	2000 ft
Above 10000 ft	10% of elevation + 1000ft

Note: For the last route segment ending over the initial approach fix, a reduction to 1000 ft is permissible within TMAs where, due to the number and type of available navigation aids, a high degree of navigational accuracy is warranted.

- 3) The resulting value is adjusted to the nearest 100 ft.
- 4) Minimum safe Grid Altitude (MGA). Calculation of the MGA is based on the elevation of the highest point within the respective grid area.
- 5) The MGA is calculated by adding an increment to the elevation specified above as appropriate:

Elevation of highest point	Increment
Not above 5000 ft	1500 ft
Above 5000 ft but not above 10000 ft	2000 ft
Above 10000 ft	10% of elevation + 1000ft

The resulting value is adjusted to the nearest 100 ft.

4.2.7.3 If an operator chooses any other additional method to establish the minimum flight altitude, such method will only be approved by the CAAM after careful consideration of the probable effects of the following factors on the safety of the operation in question.

- a) the accuracy and reliability with which the position of the aeroplane can be determined.
- b) the inaccuracies in the indications of the altimeters used.
- c) the characteristics of the terrain (e.g. sudden changes in the elevation).

- d) the probability of encountering unfavourable meteorological conditions (e.g. severe turbulence and descending air currents).
- e) possible inaccuracies in aeronautical charts, and
- f) airspace restrictions.

4.2.8 Aerodrome Operating Minima

4.2.8.1 The operator shall establish aerodrome operating minima for each aerodrome to be used. Such minima shall not be lower than any that may be established for such aerodromes by the State of the Aerodrome, except when specifically approved by that State. The operator shall specify the method of determining aerodrome operating minima in the operations manual.

4.2.8.1.1 The CAAM may approve operational credit(s) for operations with aeroplanes equipped with automatic landing systems, a HUD or equivalent displays, EVS, SVS or CVS. Such approvals shall not affect the classification of the instrument approach procedure. Operational credit includes:

- a) for the purposes of an approach ban (4.4.1.2), a minima below the aerodrome operating minima;
- b) reducing or satisfying the visibility requirements; or
- c) requiring fewer ground facilities as compensated for by airborne capabilities.

Note 2.— Guidance on operational credit for aircraft equipped with automatic landing systems, a HUD or equivalent displays, EVS, SVS and CVS is contained in Attachment H and in the Manual of All-Weather Operations (ICAO Doc 9365).

Note 3.— Information regarding a HUD or equivalent displays, including references to RTCA and EUROCAE documents, is contained in the Manual of All-Weather Operations (ICAO Doc 9365).

4.2.8.2 The CAAM requires that, in establishing the aerodrome operating minima which will apply to any particular operation, full account shall be taken of:

- a) the type, performance and handling characteristics of the aeroplane and any conditions or limitations stated in the flight manual;
- b) the composition of the flight crew, their competence and experience;
- c) the dimensions and characteristics of the runways which may be selected for use;
- d) the adequacy and performance of the available visual and non-visual ground aids;

- e) the equipment available on the aeroplane for the purpose of navigation, acquisition of visual references and/or control of the flight path during the approach, landing and the missed approach;
- f) the obstacles in the approach and missed approach areas and the obstacle clearance altitude/height for the instrument approach procedures;
- g) the means used to determine and report meteorological conditions;
- h) the obstacles in the climb-out areas and necessary clearance margins;
- i) the conditions prescribed in the operations specifications; and
- j) any minima that may be promulgated by the State of the Aerodrome.

Note.— Guidance on the establishment of aerodrome operating minima is contained in the CAGM 6008 (III) – LVO and Manual of All-Weather Operations (ICAO Doc 9365).

4.2.8.3

Instrument approach operations shall be classified based on the designed lowest operating minima below which an approach operation shall only be continued with the required visual reference as follows:

- a) Type A: a minimum descent height or decision height at or above 75 m (250 ft); and
- b) Type B: a decision height below 75 m (250 ft). Type B instrument approach operations are categorised as:
 - 1) Category I (CAT I): a decision height not lower than 60 m (200 ft) and with either a visibility not less than 800 m or a runway visual range not less than 550 m;
 - 2) Category II (CAT II): a decision height lower than 60 m (200 ft) but not lower than 30 m (100 ft) and a runway visual range not less than 300 m;
 - 3) Category III (CAT III): a decision height lower than 30 m (100 ft) or no decision height and a runway visual range less than 300 m or no runway visual range limitations.

Note 1.— Where decision height (DH) and runway visual range (RVR) fall into different categories of operation, the instrument approach operation would be conducted in accordance with the requirements of the most demanding category (e.g. an operation with a DH in the range of CAT II but with an RVR in the range of CAT I would be considered a CAT II operation). This does not apply if the RVR and/or DH has been approved as operational credits.

Note 2. — The required visual reference means that section of the visual aids or of the approach area which should have been in view for sufficient time for the pilot to have made an assessment of the aircraft position and rate of change of position, in relation to the desired flight path. In the case of a circling approach operation, the required visual reference is the runway environment.

Note 3.— Guidance on approach classification as it relates to instrument

approach operations, procedures, runways and navigation systems is contained in CAGM 6008 (III) – LVO and the Manual of All-Weather Operations (ICAO Doc 9365).

- 4.2.8.4 An operator shall apply for a specific approval from the CAAM prior to conduct of instrument approach operations in low visibility which shall only be conducted when RVR information is provided.

Note.— Guidance on low visibility operations is contained in CAGM 6008 (III) – LVO and the Manual of All-Weather Operations (ICAO Doc 9365).

- 4.2.8.5 Prior to conducting take-offs in low visibility, an operator shall apply for a specific approval from the CAAM for the minimum take-off RVR.

Note.— In general, visibility for take-off is defined in terms of RVR. An equivalent horizontal visibility may also be used.

- 4.2.8.6 For instrument approach operations, aerodrome operating minima below 800m visibility shall not be authorised unless RVR information is provided.

- 4.2.8.7 The operating minima for 2D instrument approach operations using instrument approach procedures shall be determined by establishing a minimum descent altitude (MDA) or minimum descent height (MDH), minimum visibility and, if necessary, cloud conditions.

Note.— For guidance on applying a continuous descent final approach (CDFA) flight technique on non-precision approach procedures, refer to PANS-OPS (ICAO Doc 8168), Volume I, Part II, Section 5.

- 4.2.8.8 The operating minima for 3D instrument approach operations using instrument approach procedures shall be determined by establishing a decision altitude (DA) or decision height (DH) and the minimum visibility or RVR.

- 4.2.9 Threshold crossing height for 3D instrument approach operations

- 4.2.9.1 An operator shall establish operational procedures designed to ensure that an aeroplane being used to conduct 3D instrument approaches (instrument approaches operation using both lateral and vertical navigation guidance) crosses the threshold by a safe margin, with the aeroplane in the landing configuration and attitude.

- 4.2.10 Fuel and oil records

- 4.2.10.1 Operators shall keep records to ensure that they include an annotation of the minimum fuel required to conduct the flight, and that this fuel load is in accordance with 4.3.6 and 4.3.7 of this CAD.

- 4.2.10.2 All operators shall provide a breakdown of fuel loads such as trip fuel, alternate fuel, reserve fuel, and holding fuel. These fuel figures, when cross-checked

with the dispatch or flight release fuel quantity (or weight) with the load manifest fuel quantity (or weight), the figures shall be the same.

- 4.2.10.3 Additionally, the operator shall ensure that the flight plan includes the amount of fuel on board (in hours), and that this figure agrees with the figures for the amount of fuel annotated on both the flight release and the load manifest.
- 4.2.10.4 The operator shall make available the hourly fuel burn information in the cruise control charts in the applicable Flight Manual.
- 4.2.10.5 All increments of fuel required by this CAD (start & taxi, take-off to arrival at destination, approach and landing, missed approach, alternate fuel, holding, and contingency) shall be provided.
- 4.2.10.6 Special fuel provisions for extended range operations shall be strictly adhered to.
- 4.2.10.7 If aircraft are dispatched without an alternate, adequate contingency fuel shall be carried for un-forecast winds, terminal area delays, runway closures, and contingencies.
- 4.2.10.8 Minimum fuel procedures shall be specified for both dispatchers and pilot-in-command's and shall be adequate for the environment in which operations are conducted.
- 4.2.10.9 The operator shall maintain oil records to enable the CAAM to ascertain that trends for oil consumption are such that an aeroplane has sufficient oil to complete each flight
- 4.2.10.10 Fuel and oil records shall be retained by the operator for a period of three (3) months.
- 4.2.11 Crew
- 4.2.11.1 For each flight, an operator shall designate one pilot to act as pilot-in-command.
- 4.2.11.2 The pilot-in-command shall, in an emergency situation that requires immediate decision and action, take any action he considers necessary under the circumstances. In such cases he may deviate from rules, operational procedures and methods in the interest of safety.
- 4.2.11.3 Cosmic Radiation
- 4.2.11.3.1 An operator shall maintain records of cosmic radiation for each flight of an aeroplane above 15 000 m (49 000 ft). This is to determine the total cosmic radiation dose received by each crew member over a period of 12 consecutive months.

- 4.2.11.3.2 Where in-flight exposure of crew members to cosmic radiation is likely to exceed 1 mSv per year the operator shall arrange working schedules, where practicable, to keep exposure below 6 mSv per year.
- 4.2.11.3.3 Crew members who are likely to be exposed to more than 6 mSv per year are considered highly exposed and individual records of exposure to cosmic radiation shall be kept for each crew member concerned.
- 4.2.12 Passengers
- 4.2.12.1 An operator shall ensure that passengers are:
- a) given briefings and demonstrations relating to safety in a form that facilitates the application of the procedures applicable in the event of an emergency.
 - b) made familiar with the location and use of the safety briefing card on which picture-type instructions indicate the operation of emergency equipment and exits likely to be used by passengers.
 - c) are seated where, in the event that an emergency evacuation is required, they are able to assist and not hinder evacuation of the aircraft.
 - d) prior to and during taxiing, take-off and landing, and whenever deemed necessary in the interest of safety by the pilot-in-command, each passenger on board occupies a seat or berth and has his safety belt or restraint device properly secured.
 - e) multiple occupancy is only allowed on specified aircraft seats occupied by one adult and one infant properly secured by a supplementary loop belt or other restraint device.
- 4.2.12.2 Passenger briefings shall contain, but not limited to the following:
- a) Before take-off.
 - 1) Briefed on the following items if applicable:
 - i) any cabin secured aspects, e.g. required position of seatbacks, tray tables, footrests, window blinds.
 - ii) location of emergency exits.
 - iii) location and use of floor proximity escape path markings.
 - iv) stowage of hand baggage.
 - v) the use and stowage of portable electronic devices.
 - vi) the location and the contents of the safety briefing card.
 - 2) Received a demonstration of the following:
 - i) the use of safety belts or restraint systems, including how to fasten and unfasten the safety belts or restraint systems.
 - ii) the location and use of oxygen equipment, if required.

- iii) the location and use of oxygen equipment, if required. Passengers should also be briefed to extinguish all smoking materials when oxygen is being used.
 - iv) the location and use of life-jackets, if required.
 - b) After take-off.
 - 1) Reminded of the following, if applicable:
 - i) use of safety belts or restraint systems including the safety benefits of having safety belts fastened when seated irrespective of seat belt sign illumination.
 - ii) caution when opening overhead compartments
 - c) Before landing.
 - 1) Reminded of the following, if applicable:
 - i) use of safety belts or restraint systems.
 - ii) back of the seat to be in the upright position and tray table stowed.
 - iii) re-stowage of hand baggage.
 - iv) the use and stowage of portable electronic devices.
 - d) After landing.
 - 1) Reminded of the following:
 - i) use of safety belts and/or restraint systems.
 - ii) the use and stowage of portable electronic devices.
 - iii) caution when opening overhead compartment
 - e) Emergency during flight.
 - 1) passengers shall be instructed as appropriate to the circumstances.
 - f) Smoking regulations.
 - 1) The operator should determine the frequency of briefings or reminding passengers about the smoking regulations.
- 4.2.12.3 For single-pilot operations without cabin crew, the pilot-in-command shall provide safety briefings to passengers except during critical phases of flight and taxiing.
- 4.2.12.4 The operator shall ensure that in an emergency during flight, passengers are instructed in such emergency action as may be appropriate to the circumstances.
- 4.2.12.5 The operator shall ensure that, during take-off and landing and whenever considered necessary by reason of turbulence or any emergency occurring during flight, all passengers on board an aeroplane shall be secured in their seats by means of the seat belts or harnesses provided.

4.3 Flight preparation

- 4.3.1 An operator shall ensure that a flight is not commenced until flight preparation forms have been completed certifying that the pilot-in-command is satisfied that:
- a) all items concerning the airworthiness and registration of the aircraft, instrument and equipment, loading, mass and centre of gravity (CG) location, baggage and cargo and aircraft operating limitations can be complied with.
 - b) the aircraft is not operated contrary to the provisions of the configuration deviation list (CDL).
 - c) the parts of the OM that are required for the conduct of the flight are available.
 - d) the documents, additional information and forms required to be available are on board.
 - e) current maps, charts and associated documentation or equivalent data are available to cover the intended operation of the aircraft including any diversion that may reasonably be expected.
 - f) ground facilities and services required for the planned flight are available and adequate.
 - g) a maintenance release as prescribed in para 8.8 has been issued in respect of the aeroplane.
 - h) the provisions specified in the OM in respect of fuel, oil, oxygen, minimum safe altitudes, aerodrome operating minima and availability of alternate aerodromes, where required, can be complied with for the planned flight
 - i) the Standards of 4.3.3 relating to operational flight planning have been complied with.
 - j) any additional operational limitation can be complied with.
 - k) Before commencing the flight, the pilot-in-command shall:
 - 1) ascertain by every reasonable means available that the ground facilities including communication facilities and navigation aids available and directly required on such a flight, for the safe operation of the aircraft, are adequate for the type of operation under which the flight is to be conducted.
 - 2) be familiar with all available meteorological information appropriate to the intended flight. Preparation for a flight away from the vicinity of the place of departure shall include:
 - i) a study of available current weather reports and forecasts.
 - ii) the planning of an alternative course of action to provide for the eventuality that the flight cannot be completed as planned, because of weather conditions.

- 4.3.1.1 During any phase of operation, the loading, mass and centre of gravity (CG) of the aircraft shall comply with the limitations specified in the flight manual, or the operations manual if more restrictive.
- 4.3.1.2 The operator shall ensure that the loading of:
- a) its aircraft is performed under the supervision of qualified personnel; and
 - b) traffic load is consistent with the data used for the calculation of the aircraft mass and balance.
- 4.3.1.3 The operator shall comply with additional structural limits such as the floor strength limitations, the maximum load per running metre, the maximum mass per cargo compartment and the maximum seating limit.
- 4.3.1.4 The operator shall specify, in the operations manual, the principles and methods involved in the loading and in the mass and balance system that meet the requirements contained in the CAD 6805 – Mass and Balance Programme. This system shall cover all types of intended operations.
- 4.3.1.5 The operator shall establish mass and balance data and produce mass and balance documentation prior to each flight specifying the load and its distribution. The mass and balance documentation shall enable the pilot-in-command to determine that the load and its distribution is such that the mass and balance limits of the aircraft are not exceeded. The mass and balance documentation shall contain the following information:
- a) Aircraft registration and type;
 - b) Flight identification, number and date;
 - c) Name of the pilot-in-command;
 - d) Name of the person who prepared the document;
 - e) Dry operating mass and the corresponding CG of the aircraft
 - f) Mass of the fuel at take-off and the mass of trip fuel;
 - g) Mass of consumables other than fuel, if applicable;
 - h) Load components including passengers, baggage, freight and ballast;
 - i) Take-off mass, landing mass and zero fuel mass;
 - j) Applicable aircraft CG positions; and
 - k) The limiting mass and CG values.

The information above shall be available in flight planning documents or mass and balance systems.

- 4.3.1.6 The person supervising the loading of the aircraft shall confirm by hand signature or equivalent that the load and its distribution are in accordance with the mass and balance documentation given to the pilot-in-command. The pilot-in-command shall indicate his acceptance by hand signature or equivalent.
- 4.3.1.7 The operator shall specify procedures for last minute changes to the load to ensure that:
- a) any last minute change after the completion of the mass and balance documentation is brought to the attention of the pilot-in-command and entered in the flight planning documents containing the mass and balance documentation;
 - b) the maximum last minute change allowed in passenger numbers or hold load is specified; and
 - c) new mass and balance documentation is prepared if this maximum number is exceeded.

Note. – Refer to CAD 6805 – Mass and Balance Programme for details on aircraft weighing, masses for passengers, crew members, baggage and cargo.

- 4.3.2 An operator shall ensure that the flight preparation forms and information used for the preparation and execution of a flight are stored in an acceptable form, accessible to the CAAM, for the period of 3 months.

4.3.3 Operational flight planning

- 4.3.3.1 An operator shall ensure that an operational flight plan is completed for each intended flight. The operational flight plan shall be approved and signed by the pilot-in-command and, where applicable, signed by the flight dispatcher. A copy shall be filed with the operator or a designated agent, or, if these procedures are not possible, it shall be left with the aerodrome authority or on record in a suitable place at the point of departure.

- 4.3.3.1.1 The operational flight plan used and the entries made during flight shall contain the following items:
- a) aircraft registration.
 - b) aircraft type and variant.
 - c) date of flight.
 - d) flight identification.
 - e) place of departure.
 - f) time of departure (actual off-block time, take-off time).
 - g) place of arrival (planned and actual).
 - h) time of arrival (actual landing and on-block time).

- i) type of operation (EDTO, VFR, ferry flight, etc.).
- j) route and route segments with checkpoints/waypoints, distances, time and tracks.
- k) planned cruising speed and flying times between checkpoints/waypoints (estimated and actual times overhead).
- l) safe altitudes and minimum levels.
- m) planned altitudes and flight levels.
- n) fuel calculations (records of in-flight fuel checks).
- o) alternate(s) for destination and, where applicable, take-off and en-route, including information required in (l) to (o).
- p) initial ATS flight plan clearance and subsequent reclearance.
- q) in-flight replanning calculations.
- r) relevant meteorological information.

4.3.3.1.2 Items that are readily available in other documentation or from another acceptable source or are irrelevant to the type of operation may be omitted from the operational flight plan.

4.3.3.1.3 All entries on the operational flight plan shall be made concurrently and be permanent in nature.

4.3.3.2 The operational flight plan and its use shall be described in the OM.

4.3.4 Alternate aerodromes

4.3.4.1 An operator shall establish procedures for the selection of destination and/or alternate aerodromes when planning a flight.

4.3.4.2 An operator shall select and specify in the operational flight plan a take-off alternate aerodrome if either the meteorological conditions at the aerodrome of departure are below the operator's established aerodrome landing minima for that operation or if it would not be possible to return to the aerodrome of departure for other reasons.

4.3.4.2.1 The take-off alternate aerodrome in relation to the departure aerodrome shall be located within:

- a) For two-engine aeroplanes, either:
 - 1) One-hour flight time at a one-engine-inoperative cruising speed according to the aircraft operating manual in still air standard conditions based on the actual take-off mass; or

- 2) The operator’s approved EDTO diversion time, subject to any MEL restriction, up to a maximum of two hours, at the one-engine-inoperative cruising speed according to the aircraft operating manual in still air standard conditions based on the actual take-off mass for aeroplanes and crews authorised for EDTO; or
- b) For three and four-engined aeroplanes, two hours flying time at the one engine inoperative cruising speed according to the aircraft operating manual in still air standards conditions based on the actual take-off mass;

If the flight manual does not contain a one-engine-inoperative cruising speed, the speed to be used for calculation must be that which is achieved with the remaining engine(s) set at maximum continuous power.

4.3.4.2.2 An operator shall only select an aerodrome as a take-off alternate aerodrome when the appropriate weather reports or forecasts or any combination thereof indicate that, during a period commencing 1 hour before and ending 1 hour after the estimated time of arrival at the aerodrome, the weather conditions will be at or above the applicable landing minima specified.

4.3.4.2.3 The ceiling must be taken into account when the only approaches available are non-precision and/or circling approaches. Any limitation related to one engine inoperative operations must be taken into account.

4.3.4.3 An operator shall not select an aerodrome as an en-route alternate aerodrome unless the appropriate weather reports or forecasts, or any combination thereof,

- a) indicate that, during a period commencing 1 hour before and ending 1 hour after the expected time of arrival at the aerodrome, the weather conditions will be at or above the planning minima in accordance with Table 1 below.

Table 1

Type of approach	Planning Minima
Cat II and III	Cat I RVR
Cat I	Non-Precision Approach RVR / Visibility Ceiling shall be at or above the MDH
Non-precision	Non-Precision Approach RVR / Visibility + 1000m Ceiling shall be at or above the MDH + 200ft
Circling	Circling

- b) The operator shall only select an aerodrome as an EDTO (or ETOPS) en-route alternate aerodrome when the appropriate weather reports or forecasts, or any combination thereof, indicate that between one hour before the anticipated time of landing until one hour after the latest possible time of landing, conditions will exist at or above the planning minima calculated by adding the additional limits of Table 2

- 1) The operator shall include in the operations manual the method for determining the operating minima at the planned ETOPS en-route alternate aerodrome.

Table 2

Planning minima for the EDTO en-route alternate aerodrome

Type of approach	Planning minima
Precision approach	DA/H +200ft RVR/VIS +800m ⁽¹⁾
Non precision approach or circling approach	MDA/H +400ft ⁽¹⁾ RVR/VIS +1500m
(1) VIS: visibility; MDA/H: minimum descent altitude/height.	

- 4.3.4.3.1 An operator shall specify any required alternate(s) including EDTO (or ETOPS) in the operational and ATC flight plan.
- 4.3.4.4 For a flight to be conducted in accordance with the instrument flight rules, at least one destination alternate aerodrome shall be selected and specified in the operational and ATS flight plans, unless:
 - a) the duration of flight from the departure aerodrome, or from the point of in-flight replanning, to the destination aerodrome is such that, taking into account all meteorological conditions and operational information relevant to the flight, during a period commencing 1 hour before and ending 1 hour after the estimated time of arrival, a reasonable certainty exists that:
 - 1) the approach and landing may be made under visual meteorological conditions; and
 - 2) separate runways are available and useable at the destination and the appropriate weather reports or forecasts for the destination aerodrome, or any combination thereof, indicate that for the period from one hour before until one hour after the expected time of arrival at destination aerodrome, the ceiling will be at least 2000 ft or circling height + 500 ft, whichever is greater, and the visibility will be at least 5 km, with at least one runway having an operational instrument approach procedure; or
 - b) the aerodrome is isolated. Operations into isolated aerodromes do not require the selection of a destination alternate aerodrome(s) and shall be planned in accordance with 4.3.6.3 d) 4)
 - 1) for each flight into an isolated aerodrome a point of no return shall be determined; and
 - 2) a flight to be conducted to an isolated aerodrome shall not be continued past the point of no return unless a current assessment of meteorological conditions, traffic and other operational conditions

indicate that a safe landing can be made during a period commencing 1 hour before and ending 1 hour after the estimated time of arrival.

Note 1. – Separate runways are two or more runways at the same aerodrome configured such that if one runway is closed, operations to the other runway(s) can be continued.

Note 2.— Guidance on planning operations to isolated aerodromes is contained in the Flight Planning and Fuel Management (FPFM) Manual (ICAO Doc 9976).

- 4.3.4.4.1 An operator shall select two destination aerodrome alternates when:
- a) The appropriate weather reports or forecasts for the destination aerodrome, or any combination thereof, indicate that during a period commencing 1 hour before and ending 1 hour after the estimated time of arrival, the weather conditions will be below the applicable planning minima; or
 - b) No meteorological information is available.
- 4.3.4.5 Planning minima for a destination aerodrome (except isolated destination aerodromes). The destination aerodrome shall only be selected when:
- a) the appropriate weather reports or forecasts, or any combination thereof, indicate that, during a period commencing 1 hour before and ending 1 hour after the estimated time of arrival at the aerodrome, the weather conditions will be at or above the applicable planning minima as follows:
 - 1) RVR/visibility specified for the Aerodrome Operating Minima; and
 - 2) For a non-precision approach or a circling approach, the ceiling at or above MDH; or
 - b) two (2) destination alternate aerodromes are selected.
- 4.3.4.6 Notwithstanding the provisions in 4.3.4.2, 4.3.4.3 and 4.3.4.4 above, the CAAM may, based on the results of a specific safety risk assessment conducted by the operator which demonstrates how an equivalent level of safety will be maintained, approve operational variations to alternate aerodrome selection criteria. The specific safety risk assessment shall include at least the:
- a) capabilities of the operator.
 - b) overall capability of the aeroplane and its systems.
 - c) available aerodrome technologies, capabilities and infrastructure.
 - d) quality and reliability of meteorological information.
 - e) identified hazards and safety risks associated with each alternate aerodrome variation; and

- f) specific mitigation measures.

4.3.5 Meteorological conditions

- 4.3.5.1 A flight to be conducted in accordance with VFR shall not be commenced unless current meteorological reports or a combination of current reports and forecasts indicate that the meteorological conditions along the route or that part of the route to be flown under VFR will, at the appropriate time, be such as to enable compliance with these rules.
- 4.3.5.2 A flight to be conducted in accordance with the instrument flight rules shall not:
 - a) take-off from the departure aerodrome unless the meteorological conditions, at the time of use, are at or above the operators established aerodrome operating minima for that operation; and
 - b) take-off or continue beyond the point of in-flight re-planning unless at the aerodrome of intended landing or at each alternate aerodrome to be selected in compliance with 4.3.4, current meteorological reports or a combination of current reports and forecasts indicate that the meteorological conditions will be, during a period commencing 1 hour before and ending 1 hour after the estimated time of arrival, at or above the operator's established aerodrome operating minima for that operation.
- 4.3.5.3 To ensure that an adequate margin of safety is observed in determining whether or not an approach and landing can be safely carried out at each alternate aerodrome, the operator shall specify appropriate incremental values for height of cloud base and visibility, acceptable to the CAAM, to be added to the operators established aerodrome operating minima.

Note.— Guidance on the selection of these incremental values is contained in the Flight Planning and Fuel Management (FPFM) Manual (ICAO Doc 9976).
- 4.3.5.4 An operator shall ensure that on an IFR flight, the pilot-in-command shall only continue beyond:
 - a) The decision point when using reduced contingency fuel procedure.
 - b) The pre-determined point when using the pre-determined point procedure. When information is available indicating that the expected weather conditions at the time of arrival at the destination and/or required alternate aerodrome(s) are at or above the applicable aerodrome operating minima.
- 4.3.5.5 An operator shall not operate an aeroplane in expected or actual icing conditions unless it is certificated and equipped to operate in icing conditions.
- 4.3.5.6 An operator shall not operate an aeroplane in expected or actual icing conditions at night unless it is equipped with a means to illuminate or detect the formation of ice. Any illumination that is used must be of a type that will not

cause glare or reflection that would handicap crew members in the performance of their duties.

4.3.5.7 An operator shall establish procedures to be followed when ground de-icing and anti-icing and related inspections of the aeroplane(s) are necessary.

4.3.5.8 An operator shall ensure that the pilot-in-command does not commence take-off unless the external surfaces are clear of any deposit which might adversely affect the performance and/or controllability of the aeroplane except as permitted in the Aeroplane Flight Manual.

Note — Guidance material is contained in the Manual of Aircraft Ground De-icing/Anti-icing Operations (ICAO Doc 9640).

4.3.6 Fuel requirements

4.3.6.1 An operator shall establish a fuel policy for the purpose of flight planning and in-flight re-planning to ensure that every flight carries sufficient fuel for the planned operation and reserves to cover deviations from the planned operation.

4.3.6.2 An operator shall ensure that the planning of flights is at least based upon (a) and (b) below:

a) Procedures contained in the OM and data derived from:

- 1) Data provided by the aeroplane manufacturer; or
- 2) Current aeroplane specific data derived from a fuel consumption monitoring system.

b) The operating conditions under which the flight is to be conducted including:

- 1) Realistic aeroplane fuel consumption data taking into account the effects of deferred maintenance items and/or configuration deviations.
- 2) Anticipated masses.
- 3) Expected meteorological conditions; and
- 4) Air Navigation Services Provider(s) procedures, restrictions and Notices to Airmen.

4.3.6.3 The pre-flight calculation of usable fuel required shall include:

- a) taxi fuel, which shall be the amount of fuel expected to be consumed before take-off, taking into account local conditions at the departure aerodrome and auxiliary power unit (APU) fuel consumption;
- b) trip fuel, which shall be the amount of fuel required to enable the aeroplane to fly from take-off, or the point of in-flight re-planning, until

landing at the destination aerodrome taking into account the operating conditions of 4.3.6.2 b);

- c) contingency fuel, which shall be the amount of fuel required to compensate for unforeseen factors. It shall be five per cent of the planned trip fuel or of the fuel required from the point of in-flight re-planning based on the consumption rate used to plan the trip fuel but, in any case, shall not be lower than the amount required to fly for five minutes at holding speed at 450 m (1 500 ft) above the destination aerodrome in standard conditions;

Note.— Unforeseen factors are those which could have an influence on the fuel consumption to the destination aerodrome, such as deviations of an individual aeroplane from the expected fuel consumption data, deviations from forecast meteorological conditions, extended delays and deviations from planned routings and/or cruising levels.

- d) destination alternate fuel, which shall be:
 - 1) where a destination alternate aerodrome is required, the amount of fuel required to enable the aeroplane to:
 - i) perform a missed approach at the destination aerodrome;
 - ii) climb to the expected cruising altitude;
 - iii) fly the expected routing;
 - iv) descend to the point where the expected approach is initiated; and
 - v) conduct the approach and landing at the destination alternate aerodrome; or
 - 2) where two destination alternate aerodromes are required, the amount of fuel, as calculated in 4.3.6.3 d) 1), required to enable the aeroplane to proceed to the destination alternate aerodrome which requires the greater amount of alternate fuel; or
 - 3) where a flight is operated without a destination alternate aerodrome, the amount of fuel required to enable the aeroplane to fly for 15 minutes at holding speed at 450 m (1 500 ft) above destination aerodrome elevation in standard conditions; or
 - 4) where the aerodrome of intended landing is an isolated aerodrome:
 - i) for a reciprocating engine aeroplane, the amount of fuel required to fly for 45 minutes plus 15 per cent of the flight time planned to be spent at cruising level, including final reserve fuel, or two hours, whichever is less; or
 - ii) for a turbine-engined aeroplane, the amount of fuel required to fly for two hours at normal cruise consumption above the destination aerodrome, including final reserve fuel;

- e) final reserve fuel, which shall be the amount of fuel calculated using the estimated mass on arrival at the destination alternate aerodrome, or the destination aerodrome when no destination alternate aerodrome is required:
 - 1) for a reciprocating engine aeroplane, the amount of fuel required to fly for 45 minutes, under speed and altitude conditions specified by the CAAM; or
 - 2) for a turbine-engined aeroplane, the amount of fuel required to fly for 30 minutes at holding speed at 450 m (1 500 ft) above aerodrome elevation in standard conditions;
- f) additional fuel, which shall be the supplementary amount of fuel required if the minimum fuel calculated in accordance with 4.3.6.3 b), c), d) and e) is not sufficient to:
 - 1) allow the aeroplane to descend as necessary and proceed to an alternate aerodrome in the event of engine failure or loss of pressurisation, whichever requires the greater amount of fuel based on the assumption that such a failure occurs at the most critical point along the route;
 - i) fly for 15 minutes at holding speed at 450 m (1 500 ft) above aerodrome elevation in standard conditions; and
 - ii) make an approach and landing;
 - 2) allow an aeroplane engaged in EDTO to comply with the EDTO critical fuel scenario as established by the CAAM;
 - 3) meet additional requirements not covered above;

Note 1.— Fuel planning for a failure that occurs at the most critical point along a route (4.3.6.3 f) 1)) may place the aeroplane in a fuel emergency situation based on 4.3.7.2.

Note 2.— Guidance and requirements on EDTO critical fuel scenarios is contained in CAGM 6008 (IV) EDTO.

- c) discretionary fuel, which shall be the extra amount of fuel to be carried at the discretion of the pilot-in-command.

4.3.6.4 A flight shall not commence unless the usable fuel on board meets the requirements in 4.3.6.3 a), b), c), d), e) and f) if required and shall not continue from the point of in-flight re-planning unless the usable fuel on board meets the requirements in 4.3.6.3 b), c), d), e) and f) if required.

4.3.6.5 Notwithstanding the provisions in 4.3.6.3 a), b), c), d) and f), the CAAM may, based on the results of a specific safety risk assessment conducted by the operator which demonstrates how an equivalent level of safety will be maintained, approve variations to the pre-flight fuel calculation of taxi fuel, trip

fuel, contingency fuel, destination alternate fuel, and additional fuel. The specific safety risk assessment shall include at least the:

- a) flight fuel calculations;
- b) capabilities of the operator to include:
 - 1) a data-driven method that includes a fuel consumption monitoring programme; and/or
 - 2) the advanced use of alternate aerodromes; and
- c) specific mitigation measures.

Note.— Guidance on the specific safety risk assessment, fuel consumption monitoring programmes and the advanced use of alternate aerodromes is contained in the Flight Planning and Fuel Management (FPFM) Manual (ICAO Doc 9976).

- 4.3.6.6 The use of fuel after flight commencement for purposes other than originally intended during pre-flight planning shall require a re-analysis and, if applicable, adjustment of the planned operation.

Note.— Guidance on procedures for in-flight fuel management including re-analysis, adjustment and/or re-planning considerations when a flight begins to consume contingency fuel before take-off is contained in the Flight Planning and Fuel Management (FPFM) Manual (ICAO Doc 9976).

4.3.7 In-flight fuel management

- 4.3.7.1 The operator shall establish policies and procedures, approved by the CAAM, to ensure that in-flight fuel checks and fuel management are performed.

- 4.3.7.2 The pilot-in-command shall continually ensure that the amount of usable fuel remaining on board is not less than the fuel required to proceed to an aerodrome where a safe landing can be made with the planned final reserve fuel remaining upon landing

Note.— The protection of final reserve fuel is intended to ensure a safe landing at any aerodrome when unforeseen occurrences may not permit safe completion of an operation as originally planned. Guidance on flight planning, including the circumstances that may require re-analysis, adjustment and/or re-planning of the planned operation before take-off or en-route, is contained in the Flight Planning and Fuel Management (FPFM) Manual (ICAO Doc 9976).

- 4.3.7.3 The pilot-in-command shall request delay information from ATC when unanticipated circumstances may result in landing at the destination aerodrome with less than the final reserve fuel plus any fuel required to proceed to an alternate aerodrome or the fuel required to operate to an isolated aerodrome.

4.3.7.4 The pilot-in-command shall advise ATC of a minimum fuel state by declaring MINIMUM FUEL when, having committed to land at a specific aerodrome, the pilot calculates that any change to the existing clearance to that aerodrome may result in landing with less than the planned final reserve fuel.

Note — The declaration of MINIMUM FUEL informs ATC that all planned aerodrome options have been reduced to a specific aerodrome of intended landing and any change to the existing clearance may result in landing with less than the planned final reserve fuel. This is not an emergency situation but an indication that an emergency situation is possible should any additional delay occur.

4.3.7.5 The pilot-in-command shall declare an emergency by broadcasting MAYDAY MAYDAY MAYDAY FUEL when calculated usable fuel on landing, at the nearest adequate aerodrome where a safe landing can be performed, is less than final reserve fuel.

4.3.7.6 Additionally, the following criteria may be used:

a) Inflight Fuel Check:

1) The pilot-in-command shall ensure that fuel checks are carried out inflight at regular intervals. The usable remaining fuel shall be recorded and evaluated to:

- i) compare actual consumption with planned consumption;
- ii) check that the usable remaining fuel is sufficient to complete the flight, in accordance with the provision in Paragraph (b) 'Inflight fuel management' below; and
- iii) determine the expected usable fuel remaining on arrival at the destination aerodrome.

2) The relevant fuel data must be recorded.

b) Inflight fuel management.

1) The flight shall be conducted so that the expected usable fuel remaining on arrival at the destination aerodrome is not less than:

- i) the required alternate fuel plus final reserve fuel, or
- ii) the final reserve fuel if no alternate aerodrome is required.

2) However, if, as a result of an inflight fuel check, the expected usable fuel remaining on arrival at the destination aerodrome is less than:

- i) the required alternate fuel plus final reserve fuel, the pilot-in-command shall take into account the traffic and the operational conditions prevailing at the destination aerodrome, at the destination alternate aerodrome and at any other adequate aerodrome, in deciding whether to proceed to the destination

- aerodrome or to divert so as to perform a safe landing with not less than final reserve fuel, or
- ii) the final reserve fuel if no alternate aerodrome is required, the pilot-in-command must take appropriate action and proceed to an adequate aerodrome so as to perform a safe landing with not less than final reserve fuel.
- 3) The pilot-in-command shall declare an emergency when the calculated usable fuel on landing at the nearest adequate aerodrome where a safe landing can be performed, is less than final reserve fuel.
 - 4) On a flight using the RCF procedure, to proceed to the destination aerodrome, the pilot-in-command shall ensure that the usable fuel remaining at the decision point is at least the total of:
 - i) trip fuel from the decision point to the destination aerodrome;
 - ii) contingency fuel equal to 5% of trip fuel from the decision point to the destination aerodrome;
 - iii) destination aerodrome alternate fuel, if a destination alternate is required; and
 - iv) final reserve fuel.
 - 5) On a flight using the PDP procedure to proceed to the destination aerodrome, the pilot-in-command shall ensure that the usable fuel remaining at the PDP is at least the total of:
 - i) trip fuel from the PDP to the destination aerodrome;
 - ii) contingency fuel from the PDP to the destination aerodrome; and
 - iii) additional fuel.

4.3.8 Re/de-fuelling with passengers on board

4.3.8.1 An operator shall establish operational procedures for re/de-fuelling with passengers embarking, on board or disembarking to ensure the following precautions are taken:

- a) One qualified person must remain at a specified location during fuelling operations with passengers on board. This qualified person must be capable of handling emergency procedures concerning fire protection and fire-fighting, handling communications and initiating and directing an evacuation.
- b) A two-way communication shall be established and shall remain available by the aeroplane's inter-communication system or other suitable means between the ground crew supervising the refuelling and the qualified personnel on board the aeroplane.
- c) Crew, staff and passengers must be warned that re/defueling will take place.
- d) Fasten seat belts sign must be off.

- e) NO SMOKING' signs must be on, together with interior lighting to enable emergency exits to be identified.
- f) Passengers must be instructed to unfasten their seat belts and refrain from smoking.
- g) Sufficient qualified personnel must be on board and be prepared for an immediate emergency evacuation.
- h) If the presence of fuel vapour is detected inside the aeroplane, or any other hazard arises during re/defueling, fuelling must be stopped immediately.
- i) The ground area beneath the exits intended for emergency evacuation and slide deployment areas must be kept clear.
- j) Provision is made for a safe and rapid evacuation.

Note — Additional precautions are required when refuelling with fuels other than aviation kerosene or when refuelling results in a mixture of aviation kerosene with other aviation turbine fuels, or when an open line is used.

4.3.9 Oxygen Supply

4.3.9.1 Pressurised Aeroplane.

4.3.9.1.1 Pressurised aeroplanes operated at pressure altitudes above 10 000 ft shall be equipped with supplemental oxygen equipment that is capable of storing and dispensing the oxygen supplies in accordance with Table 1.

4.3.9.1.2 Pressurised aeroplanes operated at pressure altitudes above 25 000 ft shall be equipped with:

- a) quick donning types of masks for flight crew members;
- b) sufficient spare outlets and masks or portable oxygen units with masks distributed evenly throughout the passenger compartment, to ensure immediate availability of oxygen for use by each required cabin crew member;
- c) an oxygen dispensing unit connected to oxygen supply terminals immediately available to each cabin crew member, additional crew member and occupants of passenger seats, wherever seated; and
- d) a device to provide a warning indication to the flight crew of any loss of pressurisation.

4.3.9.1.3 In the case of pressurised aeroplanes first issued with an individual CofA after 8 November 1998 and operated at pressure altitudes above 25 000 ft, or operated at pressure altitudes at, or below 25 000 ft under conditions that would not allow them to descend safely to 13 000 ft within four minutes,

the individual oxygen dispensing units referred to in 4.3.9.1.2 c) shall be automatically deployable.

- 4.3.9.1.4 The total number of dispensing units and outlets referred to in 4.3.9.1.2 c) and 4.3.9.1.3 shall exceed the number of seats by at least 10 %. The extra units shall be evenly distributed throughout the passenger compartment.
- 4.3.9.1.5 Notwithstanding 4.3.9.1.1, the oxygen supply requirements for cabin crew member(s), additional crew member(s) and passenger(s), in the case of aeroplanes not certified to fly at altitudes above 25 000 ft, may be reduced to the entire flying time between 10 000 ft and 13 000 ft cabin pressure altitudes for all required cabin crew members and for at least 10 % of the passengers if, at all points along the route to be flown, the aeroplane is able to descend safely within four minutes to a cabin pressure altitude of 13 000 ft.
- 4.3.9.1.6 The required minimum supply in Table 1, row 1 item (b)(1) and row 2, shall cover the quantity of oxygen necessary for a constant rate of descent from the aeroplane’s maximum certified operating altitude to 10 000 ft in 10 minutes and followed by 20 minutes at 10 000 ft.
- 4.3.9.1.7 The required minimum supply in Table 1, row 1 item 1(b)(2), shall cover the quantity of oxygen necessary for a constant rate of descent from the aeroplane’s maximum certified operating altitude to 10 000 ft in 10 minutes followed by 110 minutes at 10 000 ft.
- 4.3.9.1.8 The required minimum supply in Table 1, row 3, shall cover the quantity of oxygen necessary for a constant rate of descent from the aeroplane’s maximum certified operating altitude to 15 000 ft in 10 minutes.

Table 1

SUPPLY FOR:	DURATION AND CABIN PRESSURE ALTITUDE
1. Occupants of flight crew compartment seats on flight crew compartment duty	<ul style="list-style-type: none"> a) The entire flight time when the cabin pressure altitude exceeds 13000 ft. b) The remainder of the flying time when the cabin pressure altitude exceeds 10000 ft but does not exceed 13000 ft, after the first 30 minutes at those altitudes, but in no case less than: <ul style="list-style-type: none"> 1) 30 minutes supply for aeroplanes certified to fly at altitudes not exceeding 25000 ft. 2) 2 hours supply for aeroplanes certified to fly at altitudes of more than 25000 ft.
2. Required cabin crew members	<ul style="list-style-type: none"> a) The entire flight time when cabin pressure altitude exceeds 13000 ft but not less than 30 minutes supply, b) the remainder of the flying time when cabin pressure altitude is greater than 10000 ft but does not exceed 13000 ft after the first 30 minutes at these altitudes.
3. 100% of passengers (see Note)	Entire flight time when the cabin pressure altitude exceeds 15000 ft but in no case less than 10 minutes supply
4. 30% of passengers (see Note)	Entire flight time when the cabin pressure altitude exceeds 14000 ft but does not exceed 15000 ft.

5. 10% of passengers (see Note)	The remainder of the flying time when the cabin pressure altitude exceeds 10000 ft but does not exceed 14000 ft after the first 30 minutes at these altitudes.
---------------------------------	--

Note. – For the purpose of this table ‘passengers’ means passengers actually carried and includes infants under the age of 24 months.

4.3.9.2 Non-pressurised Aeroplanes.

4.3.9.2.1 Non-pressurised aeroplanes operated at pressure altitudes above 10 000 ft shall be equipped with supplemental oxygen equipment capable of storing and dispensing the oxygen supplies in accordance with Table 2.

Table 2

(a) SUPPLY FOR:	(b) DURATION AND PRESSURE ALTITUDE
1. All occupants of flight crew compartment seats and crew members assisting flight crew in their duties	Entire flight time at pressure altitudes above 10000 ft.
2. All required cabin crew members	Entire flight time at pressure altitudes above 13000 ft and for any period exceeding 30 minutes at pressure altitudes above 10000 ft but not exceeding 13000 ft.
3. 100% of passengers (See Note)	Entire flight time at pressure altitudes above 13000 ft.
4. 10% of passengers (See Note)	Entire flight time after 30 minutes at pressure altitudes greater than 10000 ft but not exceeding 13000 ft.

Note. – For the purpose of this table ‘passengers’ means passengers actually carried and includes infants under the age of 24 months.

4.3.9.3 First-aid oxygen

4.3.9.3.1 Pressurised aeroplanes operated at pressure altitudes above 25000 ft, in the case of operations for which a cabin crew member is required, shall be equipped with a supply of undiluted oxygen for passengers who, for physiological reasons, might require oxygen following a cabin depressurisation.

4.3.9.3.2 The oxygen supply referred to in 4.3.9.3.1 shall be sufficient for the remainder of the flight after the cabin depressurisation when the cabin altitude exceeds 8000 ft but does not exceed 15000 ft, for at least 2% of the passengers carried, but in no case for less than one person.

4.3.9.3.3 There shall be a sufficient number of dispensing units, but in no case less than two, with a means for cabin crew to use the supply.

4.3.9.3.4 The first-aid oxygen equipment shall be capable of generating a mass flow to each person.

4.3.10 Time capability of cargo compartment fire suppression system

- 4.3.10.1 All flights shall be planned so that the diversion time to an aerodrome where a safe landing could be made does not exceed the cargo compartment fire suppression time capability of the aeroplane, when one is identified in the relevant aeroplane documentation, reduced by an operational safety margin specified by the CAAM.

Note 1 — Cargo compartment fire suppression time capabilities will be identified in the relevant aeroplane documentation when they are to be considered for the operation.

Note 2 — Fifteen minutes is an operational safety margin commonly retained for that purpose.

Note 3 — Refer to Chapter 4, 4.7 and CAGM 6008 (IV) EDTO for considerations of time capability of cargo compartment fire suppression systems for aeroplanes engaged in EDTO.

4.4 In-flight procedures

4.4.1 Aerodrome operating minima

- 4.4.1.1 A flight shall not be continued towards the aerodrome of intended landing, unless the latest available information indicates that at the expected time of arrival, a landing can be effected at that aerodrome or at least one destination alternate aerodrome, in compliance with the operating minima established in accordance with 4.2.8.1.
- 4.4.1.2 The pilot-in-command of the flight may commence an instrument approach regardless of the reported RVR/Visibility but the approach shall not be continued beyond the outer marker, or equivalent position, if the reported RVR/visibility is less than the applicable minima.
- 4.4.1.3 If, after passing the outer marker or equivalent position in accordance with (a) above, the reported RVR/visibility falls below the applicable minimum, the approach may be continued to DA/H or MDA/H. In any case, an aeroplane shall not continue its approach-to-land at any aerodrome beyond a point at which the limits of the operating minima specified for that aerodrome would be infringed.
- 4.4.1.4 Where no outer marker or equivalent position exists, the pilot-in-command of the flight shall make the decision to continue or abandon the approach before descending below 1000 ft above the aerodrome on the final approach segment.

- 4.4.1.5 If the MDA/H is at or above 1000 ft above the aerodrome, the operator shall establish a height, for each approach procedure, below which the approach shall not be continued if the RVR/visibility is less than the applicable minima.
- 4.4.2 Meteorological observations
- 4.4.2.1 An operator shall ensure that the pilot-in-command report the runway braking action special air-report (AIREP) when the runway braking action encountered is not as good as reported.
- 4.4.3 Hazardous flight conditions
- 4.4.3.1 The operator shall ensure that the pilot-in-command notify the appropriate air traffic services unit as soon as practicable whenever a potentially hazardous condition other than those associated with meteorological conditions, such as an irregularity in a ground or navigational facility or a volcanic ash cloud is encountered during flight.
- 4.4.3.2 The reports so rendered shall give such details as may be pertinent to the safety of other aircraft.
- 4.4.4 Flight crew members at duty stations.
- 4.4.4.1 An operator shall ensure that a flight crew member is at his station during the following phases of flight:
- a) During take-off and landing each flight crew member required to be on flight deck duty shall be at his station.
 - b) During all other phases of flight each flight crew member required to be on flight deck duty shall remain at his station unless his absence is necessary for the performance of his duties in connection with the operation, or for physiological needs provided at least one suitably qualified pilot remains at the controls of the aeroplane at all times.
 - c) During all phases of flight each flight crew member required to be on flight deck duty shall remain alert. If a lack of alertness is encountered, appropriate countermeasures shall be used. If unexpected fatigue is experienced a controlled rest procedure, organised by the pilot-in-command, can be used if workload permits. Controlled rest taken in this way may never be considered to be part of a rest period for purposes of calculating flight time limitations nor used to justify any duty period.
- 4.4.4.2 The operator shall also ensure that each crew member shall be properly secured by all safety belts and harnesses provided during take-off and landing, and whenever deemed necessary by the pilot-in-command in the interest of safety.

- 4.4.4.3 This shall be also applicable during other phases of the flight when each flight crew member on the flight deck shall keep his safety belt fastened while at his station.
- 4.4.5 Use of oxygen.
- 4.4.5.1 An operator shall ensure that all flight crew members, when engaged in performing duties essential to the safe operation of an aeroplane in flight, shall use breathing oxygen continuously whenever the circumstances prevail for which its supply has been required by the provisions of para 4.3.9.1 and 4.3.9.2.
- 4.4.5.2 An operator shall ensure that all flight crew members of pressurised aeroplanes operating above 25 000 feet shall have available at the flight duty station a quick-donning type of oxygen mask which will readily supply oxygen upon demand.
- 4.4.5.3 A quick donning mask is the type of mask that:
- a) Can be placed on the face from its ready position, properly secured, sealed, and supplying oxygen upon demand, with one hand and within 5 seconds and will thereafter remain in position, both hands being free;
 - b) Can be put on without disturbing eye glasses and without delaying the flight crew member from proceeding with assigned emergency duties;
 - c) After being put on, does not prevent immediate communication between the flight crew members and other crew members over the aeroplane intercommunication system;
 - d) Does not inhibit radio communications.
- 4.4.6 Safeguarding of cabin crew and passengers in pressurised aeroplanes in the event of loss of pressurisation.
- 4.4.6.1 An operator shall make provision and establish procedures for safeguarding of cabin crew and passengers in pressurised aeroplanes in the event of loss of pressurisation.
- 4.4.6.2 Cabin crew shall be safeguarded so as to ensure reasonable probability of them retaining consciousness during any emergency descent which may be necessary in the event of loss of pressurisation.
- 4.4.6.3 In addition, cabin crew shall have such means of protection as will enable them to administer first aid to passengers during stabilised flight following the emergency.

- 4.4.6.4 Passengers shall be safeguarded by such devices or operational procedures as will ensure reasonable probability of them surviving the effects of hypoxia in the event of loss of pressurisation.
- 4.4.7 In-flight operational instructions.
- 4.4.7.1 An operator shall ensure that his in-flight operational instructions involving a change to the air traffic flight plan shall, when practicable, be coordinated with the appropriate Air Traffic Service unit before transmission to an aeroplane.
- 4.4.7.2 When co-ordination with an appropriate Air Traffic Service unit has not been possible, in-flight operational instructions do not relieve a pilot-in-command of responsibility for obtaining an appropriate clearance from an Air Traffic Service unit, if applicable, before making a change in flight plan.
- 4.4.8 Instrument flight procedures.
- 4.4.8.1 An operator shall ensure that instrument departure and approach procedures established by the State in which the aerodrome is located are used.
- 4.4.8.2 Notwithstanding the above, a pilot-in-command may accept an ATC clearance to deviate from a published departure or arrival route, provided obstacle clearance criteria are observed and full account is taken of the operating conditions. The final approach shall be flown visually or in accordance with the established instrument approach procedure.
- 4.4.8.3 All aeroplanes operated in accordance with instrument flight rules shall comply with the instrument flight procedures approved by the State in which the aerodrome is located.
- 4.4.9 Aeroplane operating procedures for noise abatement.
- 4.4.9.1 An operator, when required by the procedures, shall establish operating procedures for noise abatement during instrument flight operations in compliance with ICAO PANS OPS Volume 1 (ICAO Doc 8168–OPS/611).
- 4.4.9.2 Noise abatement procedures specified by an operator for any one aeroplane type should be the same for all aerodromes.
- 4.4.10 Aeroplane operating procedures for rates of climb and descent.
- 4.4.10.1 Unless otherwise specified in an air traffic control instruction, to avoid unnecessary airborne collision avoidance system (ACAS II) resolution advisories in aircraft at or approaching adjacent altitudes or flight levels, operators shall specify procedures by which an aeroplane climbing or descending to an assigned altitude or flight level, especially with an autopilot engaged, and may do so at a rate less than 8 m/sec or 1 500 ft/min (depending on the instrumentation available) throughout the last 300 m (1 000 ft) of climb

or descent to the assigned level when the pilot is made aware of another aircraft at or approaching an adjacent altitude or flight level.

4.4.11 Aeroplane operating procedures for landing performance.

4.4.11.1 An operator shall ensure that before commencing an approach to land is not continued below 300 m (1 000 ft) above aerodrome elevation, unless the pilot-in-command is satisfied that, according to the information available to him, the weather at the aerodrome and the condition of the runway intended to be used shall not prevent a safe approach, landing or missed approach, having regard to the performance information contained in the OM.

4.5 Duties of pilot-in-command

4.5.1 An operator shall specify the responsibilities and duties of the pilot-in-command in its OM including, but not limited to the following:

- a) Be responsible for the safety of all crew members, passengers and cargo on board, as soon as he arrives on board, until he leaves the aeroplane at the end of the flight;
- b) Be responsible for the operation and safety of the aeroplane from the moment the aeroplane is first ready to move for the purpose of taxiing prior to take-off until the moment it finally comes to rest at the end of the flight and the engine(s) used as primary propulsion units are shut down;
- c) Have authority to give all commands he deems necessary for the purpose of securing the safety of the aeroplane and of persons or property carried therein;
- d) Have authority to disembark any person, or any part of the cargo, which, in his opinion, may represent a potential hazard to the safety of the aeroplane or its occupants;
- e) Not allow a person to be carried in the aeroplane who appears to be under the influence of alcohol or drugs or psychoactive substances to the extent that the safety of the aeroplane or its occupants is likely to be endangered;
- f) Have the right to refuse transportation of inadmissible passengers, deportees or persons in custody if their carriage poses any risk to the safety of the aeroplane or its occupants;
- g) Ensure that all passengers are briefed on the location of emergency exits and the location and use of relevant safety and emergency equipment;
- h) Ensure that all operational procedures and check lists are complied with in accordance with the Operations Manual;

- i) Not permit any crew member to perform any activity during take-off, initial climb, final approach and landing except those duties required for the safe operation of the aeroplane;
- j) Not permit:
 - 1) A flight data recorder to be disabled, switched off or erased during flight nor permit recorded data to be erased after flight in the event of an accident or an incident subject to mandatory reporting.
 - 2) A cockpit voice recorder to be disabled or switched off during flight unless he believes that the recorded data, which otherwise would be erased automatically, shall be preserved for incident or accident investigation nor permit recorded data to be manually erased during or after flight in the event of an accident or an incident subject to mandatory reporting.
- k) Decide whether or not to accept an aeroplane with unserviceabilities allowed by the CDL or MEL.
- l) Ensure that the pre-flight inspection has been carried out.
- m) Ensure that at least one member of the flight crew holds a valid licence authorising operation of the type of radio transmitting equipment to be used.

4.5.2 In terms of incident reporting, the operator shall specify procedures for the pilot-in-command to be responsible for notifying the nearest appropriate authority by the quickest available means of any accident involving the aeroplane, resulting in serious injury or death of any person or substantial damage to the aeroplane or property.

- a) The pilot-in-command of an aeroplane shall submit a report to the CAAM of any incident that endangers or could endanger the safety of operation.
- b) Reports shall be despatched within 48 hours of the time when the incident was identified unless exceptional circumstances prevent this.

4.5.3 The provision 4.5.4 of this CAD requires that the pilot-in-command to be made responsible for reporting all known or suspected defects in the aeroplane, to the operator, at the termination of the flight.

4.5.4 In this case, the pilot-in-command shall ensure that all known or suspected technical defects and all exceedances of technical limitations occurring while he was responsible for the flight are recorded in the aircraft journey log book.

4.5.5 If the deficiency or exceedance of technical limitations endangers or could endanger the safety of operation, the pilot-in-command shall in addition initiate the submission of a report to the CAAM in accordance with the provision in the paragraph.

- 4.5.6 In the case of incidents reported, arising from, or relating to, any failure, malfunction or defect in the aeroplane, its equipment or any item of ground support equipment, or which cause or might cause adverse effects on the continuing airworthiness of the aeroplane, the operator shall also inform the organisation responsible for the design or the supplier or, if applicable, the organisation responsible for continued airworthiness, at the same time as a report is submitted to the CAAM.
- 4.5.7 In addition, the provision in 4.5.5 of this CAD, the pilot-in-command is responsible for the completion of the journey log book or the general declaration containing the information listed in the provision in 11.4.1.

4.6 Duties of flight operations officer/flight dispatcher

- 4.6.1 An operator shall ensure that a flight operations officer/flight dispatcher in conjunction with a method of control and supervision of flight operations in accordance with the provision in 4.2.1.3 performs the following:
- a) Assist the pilot-in-command in flight preparation and provide the relevant information.
 - b) Assist the pilot-in-command in preparing the operational and ATS flight plans, sign when applicable and file the ATS flight plan with the appropriate ATS unit.
 - c) Furnish the pilot-in-command while in flight, by appropriate means, with information which may be necessary for the safe conduct of the flight.
 - d) Notify the appropriate ATS unit when the position of the aeroplane cannot be determined by an aircraft tracking capability, and attempts to establish communication are unsuccessful.
- 4.6.2 In the event of an emergency, a flight operations officer/flight dispatcher shall carry out the following:
- a) initiate such procedures as outlined in the operations manual while avoiding taking any action that would conflict with ATC procedures.
 - b) convey safety-related information to the pilot-in-command that may be necessary for the safe conduct of the flight, including information related to any amendments to the flight plan that become necessary in the course of the flight.

Note.— It is equally important that the pilot-in-command also convey similar information to the flight operations officer/ flight dispatcher during the course of the flight, particularly in the context of emergency situations.

4.7 Additional requirements for operations by aeroplanes with turbine engines beyond 60 minutes to an en-route alternate aerodrome including extended diversion time operations (EDTO)

4.7.1 Requirements for operations beyond 60 minutes to an en-route alternate aerodrome.

4.7.1.1 Operators conducting operations beyond 60 minutes from a point on a route to an en-route alternate aerodrome shall ensure that:

a) for all aeroplanes:

- 1) en-route alternate aerodromes are identified; and
- 2) the most up-to-date information is provided to the flight crew on identified en-route alternate aerodromes, including operational status and meteorological conditions;

b) for aeroplanes with two turbine engines, the most up-to-date information provided to the flight crew indicates that conditions at identified en-route alternate aerodromes will be at or above the operator's established aerodrome operating minima for the operation at a period commencing 1 hour before and ending 1 hour after the estimated time of arrival

Note.— Guidance on compliance with the requirements of these provisions is contained in CAGM 6008 (IV) EDTO

4.7.1.2 In addition to the requirements in 4.7.1.1, all operators shall ensure that the following are taken into account and provide the overall level of safety intended by the provisions of this CAD:

- a) operational control and flight dispatch procedures;
- b) operating procedures; and
- c) training programmes.

4.7.2 Requirements for extended diversion time operations (EDTO)

4.7.2.1 Unless the operation has been specifically approved by the CAAM, an aeroplane with two or more turbine engines shall not be operated on a route where the diversion time to an en-route alternate aerodrome from any point on the route, calculated in ISA and still-air conditions at the one-engine-inoperative cruise speed for aeroplanes with two turbine engines and at the all engines operating cruise speed for aeroplanes with more than two turbine engines, exceeds the threshold time below:

- a) For transport category aeroplane with two turbine engines, the threshold time established is 60 minutes.
- b) For transport category aeroplane with more than two turbine engines, the threshold time established is 180 minutes.

Note 1.— When the diversion time exceeds the threshold time, the operation is considered to be an extended diversion time operation (EDTO).

Note 2.— Guidance on the establishment of an appropriate threshold time and on approval of extended diversion time operations is contained in CAGM 6008 (IV) EDTO.

Note 3.— For the purpose of EDTO, the take-off and/or destination aerodromes may be considered en-route alternate aerodromes.

4.7.2.2 A flight shall not proceed beyond the threshold time in accordance with 4.7.2.1 unless the identified en-route alternate aerodromes have been re-evaluated for availability and the most up-to-date information indicates that, during a period commencing 1 hour before and ending 1 hour after the estimated time of arrival conditions at those aerodromes will be at or above the operator's established aerodrome operating minima for the operation. If any conditions are identified that would preclude a safe approach and landing at that aerodrome during the period commencing 1 hour before and ending 1 hour after the estimated time of arrival, an alternative course of action shall be determined.

4.7.2.3 The operator shall, when requesting maximum diversion times for aeroplanes with two turbine engines, ensure that the following are taken into account in providing the overall level of safety intended by the provisions of CAD-8

- a) reliability of the propulsion system;
- b) airworthiness certification for EDTO of the aeroplane type; and
- c) EDTO maintenance programme.

4.7.2.4 The maximum diversion time for the operator of a particular aeroplane type engaged in extended diversion time operations shall be approved by the CAAM.

Note.— Guidance on the conditions to be used when converting diversion times to distances is contained in CAGM 6008 (IV) EDTO.

4.7.2.5 When requesting the appropriate maximum diversion time of a particular aeroplane type engaged in extended diversion time operations, the operator shall ensure that:

- a) For all aeroplanes: the most limiting EDTO significant system time limitation, if any, indicated in the aeroplane flight manual (directly or by reference) and relevant to that particular operation is not exceeded; and
- b) for aeroplanes with two turbine engines: the aeroplane is EDTO certified.

Note 1.— EDTO may be referred to as ETOPS in some documents.

Note 2.— Guidance on compliance with the requirements of this provision is contained in CAGM 6008 (IV) EDTO.

- 4.7.2.5.1 Notwithstanding the provisions in 4.7.2.5 a), the CAAM may, based on the results of a specific safety risk assessment conducted by the operator which demonstrates how an equivalent level of safety will be maintained, approve operations beyond the time limits of the most time-limited system. The specific safety risk assessment shall include at least the:
- a) capabilities of the operator;
 - b) overall reliability of the aeroplane;
 - c) reliability of each time-limited system;
 - d) relevant information from the aeroplane manufacturer; and
 - e) specific mitigation measures.
- Note.— Guidance on the specific safety risk assessment is contained in CAGM 6008 (IV) EDTO.*
- 4.7.2.6 For aeroplanes engaged in EDTO, the additional fuel required by 4.3.6.3 f) 2) shall include the fuel necessary to comply with the EDTO critical fuel scenario as established by the CAAM.
- Note.— Guidance on compliance with the requirements of this provision is contained in CAGM 6008 (IV) EDTO.*
- 4.7.2.7 A holder of an approval for EDTO for shall comply with the provision of paragraph 4.7.2.3
- 4.7.2.8 A holder of an approval for EDTO shall not fly an aeroplane for the EDTO if its EDTO qualified personnel has changed the status of the aeroplane to “non-EDTO”
- 4.7.2.8.1 The EDTO qualified personnel may change the status of the aeroplane if—
- a) Minimum Equipment List cannot be complied with for EDTO; or
 - b) the aeroplane configuration and/or maintenance do not comply with the applicable EDTO CMP document.
- 4.7.2.8.2 The EDTO qualified personnel may restore the aeroplane back to “EDTO” status if the operator rectifies all the EDTO discrepancies in line with the applicable EDTO CMP configuration and maintenance standards and/or the Minimum Equipment List EDTO requirements.
- 4.7.2.9 Changes affecting EDTO Approval
- c) The operator shall notify CAAM on the following changes that may affect EDTO Approval
 - 1) for aeroplanes with two turbine engines, changes affecting paragraph 4.7.2.3 ; and

- 2) A holder of an approval for EDTO for all aircraft, shall not fly an aeroplane for EDTO if there are any changes to aeroplane/engine combination of that aeroplane unless approved by the CAAM

4.7.2.10 The CAAM may require validation flights on proposed route(s) to ensure that the required EDTO airworthiness requirements and procedures are met.

4.8 Carry-on baggage

4.8.1 Procedures shall be established by the operator to ensure that all baggage carried onto an aeroplane and taken into the passenger cabin is adequately and securely stowed.

4.8.2 In addition, procedures to ensure that all baggage and cargo on board, which might cause injury or damage, or obstruct aisles and exits if displaced, is placed in stowages designed to prevent movement are also established.

4.8.3 The procedures established by an operator to ensure that hand baggage and cargo is adequately and securely stowed shall take account of, but not limited, to the following:

- a) Each item carried in a cabin must be stowed only in a location that is capable of restraining it.
- b) Mass limitations placarded on or adjacent to stowage must not be exceeded.
- c) Under seat stowage must not be used unless the seat is equipped with a restraint bar and the baggage is of such size that it may adequately be restrained by this equipment.
- d) Items must not be stowed in toilets or against bulkheads that are incapable of restraining articles against movement forwards, sideways or upwards and unless the bulkheads carry a placard specifying the greatest mass that may be placed there.
- e) Baggage and cargo placed in lockers must not be of such size that they prevent latched doors from being closed securely.
- f) Baggage and cargo must not be placed where it can impede access to emergency equipment.
- g) Checks must be made before take-off, before landing, and whenever the fasten seat belts signs are illuminated or it is otherwise so ordered to ensure that baggage is stowed where it cannot impede evacuation from the aircraft or cause injury by falling (or other movement) as may be appropriate to the phase of flight.
- h) The pilot-in-command shall ensure that before take-off and landing, and whenever deemed necessary in the interest of safety, all equipment and baggage is properly secured.

4.9 Additional requirements for single pilot operations under the instrument flight rules (IFR) or at night

4.9.1 All operations involving single pilot under the instrument flight rules (IFR) or at night shall not be permitted in accordance with Regulation 49 of the MCAR 2016.

4.10 Fatigue management

4.10.1 An operator shall ensure that the directive on fatigue management establish by the CAAM are complied with. These directives which are based upon scientific principles, knowledge and operational experience with the aim of ensuring that flight and cabin crew members are performing at an adequate level of alertness.

4.10.2 For detail prescriptive directives for flight time, flight duty period, duty period limitations and rest period requirements to manage fatigue, refer to CAD 1901 on FTL.

4.11 Additional requirements for Low Visibility Operations (LVO)

4.11.1 An operator shall not conduct LVO unless:

- a) Each aircraft concerned is certificated by the regulatory authority of the State of the Manufacturer for operations with decision heights below 200 ft, or no decision height, and accepted by CAAM or CAAM has certified the aircraft for such operations as per Chapter 3 of CAGM 6008 (III) LVO),
- b) The aerodrome is approved for such operations by the State in which the aerodrome is located.
- c) It has verified that low visibility procedures (LVP) have been established, and will be enforced, at those aerodromes where low visibility operations are to be conducted.
- d) A suitable system for recording approach and/or automatic landing success and failure is established and maintained to monitor the overall safety of the operation;
- e) The operations are approved by CAAM.
- f) The flight crew consists of at least two pilots;
- g) Decision height is determined by means of a radio altimeter.
- h) Only RVR values are used for low visibility operations.

4.11.2 The maintenance programme shall ensure that the airborne equipment necessary for low visibility operations continues to operate to the required performance level and should cover following areas and any other requirement specified by the CAAM:

- a) Maintenance procedures.
- b) Maintenance and calibration of test equipment.
- c) Initial and recurrent training of maintenance staff.
- d) Recording and analysis of airborne equipment failures.

Note. – Details of continuing airworthiness and maintenance procedures of LVO are stated in CAGM 6008 (III) LVO.

4.11.3 Responsibilities of pilot-in-command

4.11.3.1 The pilot-in-command shall satisfy himself that:

- a) The status of the visual and non-visual facilities is sufficient prior to commencing a low visibility take-off, an approach utilising EVS or a Category II or III approach;
- b) Appropriate LVPs are in force according to information received from Air Traffic Services, before commencing a low visibility take-off or a Category II or III approach; and
- c) The flight crew members are properly qualified prior to commencing a low visibility take-off in an RVR of less than 150 m (200 m for Category D aircrafts), an approach utilising EVS or a Category II or III approach.
- d) The operator has appropriate authorisation from the state of registry and the state of aerodrome to carry out a low visibility take-off or a Category II or III approach to the aerodrome intended.
- e) The aircraft is properly certified and all required equipment are serviceable for the intended low visibility take-off or a Category II or III approach (refer to paragraph 4.11.4).

4.11.4 Minimum equipment

4.11.4.1 The operator shall include in the Operations Manual the minimum equipment that has to be serviceable at the commencement of a low visibility take-off, an approach utilising EVS, or a Category II or III approach in accordance with the flight manual or other approved document.

4.11.4.2 The operator shall have procedures to indicate to the flight crew / Flight operations officer the status of the aircraft when the aircraft is upgraded/degraded due to any un serviceability as per paragraph 4.11.4.1 or any other reason.

4.11.4.3 The pilot-in-command shall satisfy himself the status of the aircraft and of the relevant airborne systems is appropriate for the specific operation to be conducted prior to departure.

4.11.5 Pilot qualifications

- 4.11.5.1 The operator shall ensure that each flight crew member completes training and a check outlined in CAGM 6008 (III) LVO before being authorised to conduct Category II or III operations.
- 4.11.5.2 The flight crew qualifications as per above paragraph 4.11.5.1 are specific to the operator and the type of aircraft in which the qualification obtained.
- 4.11.6 Crew training
- 4.11.6.1 An operator shall ensure that, prior to conducting Category II and III operations or approaches utilising EVS:
- a) Each flight crew member completes the training and checking guidelines prescribed in CAGM 6008 (III) LVO including FSTD training in operating to the limiting values of RVR and Decision Height appropriate to the operator's approval.
 - b) The training and checking is conducted in accordance with a detailed syllabus approved by the CAAM and included in the Operations Manual. This training is in addition to the training requirement for type qualifications.
- 4.11.6.2 An operator shall ensure that flight crew member training programs for low visibility operations include structured courses of ground and FSTD training.
- 4.11.7 Crew training - low visibility take-off (LVTO)
- 4.11.7.1 Low Visibility Take-Off with RVR less than 400 m.
- a) All low visibility take-off less than 400 m requires CAAM approval.
 - b) An operator must ensure that a flight crew member has completed a check before conducting Low Visibility Take-Offs in RVRs of less than 400 m.
- 4.11.7.2 Low Visibility Take-Off with RVR less than 150/200 m
- 4.11.7.2.1 An operator must ensure that prior to authorisation to conduct take-offs in RVRs below 150 m (below 200 m for Category D aeroplanes) additional training as below is carried out:-
- a) Normal take-off in minimum authorised RVR conditions;
 - b) Take-off in minimum authorised RVR conditions with an engine failure between V1 and V2, or as soon as safety considerations permit; and
 - c) Take-off in minimum authorised RVR conditions with an engine failure before V1 resulting in a rejected take-off.
- 4.11.7.2.2 An operator must ensure that the training required by subparagraphs 4.11.7.1 and 4.11.7.2.1 above is carried out in a flight simulator. This training must include the use of any special procedures and equipment.

- 4.11.7.2.3 An operator must ensure that a flight crew member has completed a check before conducting Low Visibility Take-Offs in RVRs of less than 150 m (less than 200 m for Category D aeroplanes). The check may only be replaced by successful completion of the flight simulator and/or flight training prescribed in subparagraph 4.11.7.1 on conversion to an aeroplane type.
- 4.11.7.2.4 Operator using HUD/EVS equipment wishing to conduct LVTO has to obtain further approval from CAAM.
- 4.11.8 Crew training - flight crew members conversion training
- 4.11.8.1 Conversion training requirements to conduct low visibility take-off, Category II / III operations by the operator's crew members on another type / class or variant aircraft may be abbreviated program based on paragraph 4.4 of the CAGM 6008 (III) LVO.
- 4.11.9 Recurrent training - low visibility operations
- 4.11.9.1 An operator shall ensure that all crew authorised for low visibility operations undergo an annual recurrent ground school training program which shall be an abbreviated training program covering requirements in paragraph 4.4.3 of the CAGM 6008 (III) LVO.
- 4.11.9.2 An operator shall ensure that all crew authorised for low visibility operations undergo a recurrent simulator training program in the simulator prior to the certification requirement as per paragraph 4.11.10.
- 4.11.9.3 Training programs as required in paragraph 4.11.9.1 and 4.11.9.2 shall have the approval of the CAAM and included in the Operations manual.
- 4.11.10 Crew certification for Category II / Category III operations
- 4.11.10.1 An operator shall ensure that, prior to conducting Category II and III operations or approaches utilising EVS and conducting low visibility take off, each flight crew member completes the checking requirements prescribed in this manual.
- 4.11.11 Flight crew training
- 4.11.11.1 Prior to conducting initial or recurrent Category II or Category III Checks, the Operator shall ensure that the flight crew has completed the applicable approved Category II/III training program successfully.
- 4.11.12 Flight crew records
- 4.11.12.1 The operator shall maintain records of all flight crew authorised to conduct low visibility operations.
- 4.11.12.2 The records as required as per paragraph 4.11.12.1 shall;

- a) Indicate initial and continued eligibility of the flight crew member to conduct LVTO, Category II / III operations
- b) Minima authorised and Category of operation
- c) Recency as required in paragraph 4.16 of the CAGM 6008 (III) LVO.

4.11.12.3 Each flight crew member is required to be in possession of the crew record as required in paragraph 4.11.12.1 when exercising the privileges authorised in this manual.

4.11.13 Flight dispatch procedure

4.11.13.1 An operator shall ensure requirements for low visibility operations shall be included in the operator flight dispatch procedures.

4.11.13.2 The Operator shall have a system to inform the flight dispatch office regarding the status of the aircraft in respect low visibility operations.

4.11.13.3 Procedures as required in paragraph 4.11.13.1 shall be included in the operations manual.

4.11.14 Flight operations officers

4.11.14.1 If the system of flight dispatch of the operator requires the employment of a Flight Operations Officer (FOO), the operator shall ensure that the FOO receive initial and annual recurrent training in respect of flight dispatch in connection with low visibility operations.



INTENTIONALLY LEFT BLANK

5 Aeroplane Performance Operating Limitations

5.1 General

5.1.1 Performance applicability – aeroplanes.

5.1.1.1 An operator must ensure that an aeroplane that has a maximum approved passenger seating configuration exceeding 19 and/or an aeroplane that has a maximum certificated take-off mass exceeding 27000 kg that corresponds to one of the following descriptions is operated in accordance with the specified Performance Class:

- a) a multi-engine aeroplane powered by turbo-propeller engines with a maximum approved passenger seating configuration exceeding 9 must be operated in accordance with Performance Class A;
- b) a multi-engine turbojet-powered aeroplane must be operated in accordance with Performance Class A;
- c) an aeroplane powered by reciprocating engines with a maximum approved passenger seating configuration exceeding 9 must be operated in accordance with Performance Class C.

5.1.1.2 Notwithstanding 5.1.1.1, where full compliance with 5.1.1.1 is not possible due to specific design characteristics of a large aeroplane, the operator may apply performance standards that ensure a level of safety equivalent to the appropriate Performance Class and it is approved by the CAAM.

5.1.1.3 An operator must ensure that an aeroplane that has a maximum approved passenger seating configuration not exceeding 19 and an aeroplane that has a maximum certificated take-off mass not exceeding 27000 kg that corresponds to one of the following descriptions is operated in accordance with the specified circumstances:

- a) a multi-engine aeroplane that is powered by at least one turbo-propeller engine, and has a maximum approved passenger seating configuration exceeding 9 but not exceeding 19, must be operated in accordance with Performance Class A;
- b) a multi-engine turbine-powered aeroplane must be operated in accordance with Performance Class A;
- c) a propeller-driven aeroplane with a maximum approved passenger seating configuration not exceeding 9 and a maximum certificated take-off mass not exceeding 5700 kg must be operated in accordance with Performance Class B;
- d) a single-engine aeroplane must not be operated in Instrument Meteorological Conditions or at night;

- e) a two-engine aeroplane which does not meet the climb performance specified in Performance Class B must not be operated in Instrument Meteorological Conditions or at night.

5.1.1.4 Notwithstanding 5.1.1.3, where full compliance with the requirements of 5.1.1.3 cannot be shown due to specific design characteristics of the aeroplane, an operator may apply performance standards that ensure a level of safety equivalent to the appropriate Performance Class and it is approved by the CAAM.

Note. – Refer Appendix 10 for Aeroplane Performance Class requirements.

5.1.2 Single engine routes and areas of operation.

5.1.2.1 An operator shall ensure that single engine operations are only conducted along such routes or within such areas, for which:

- a) Ground facilities and services, including meteorological services, are provided which are adequate for the planned operation.
- b) The performance of the aeroplane intended to be used is adequate to comply with minimum flight altitude requirements.
- c) The equipment of the aeroplane intended to be used meets the minimum requirements for the planned operation.
- d) Appropriate maps and charts are available (See Note below).

Note: Current maps, charts and associated documentation or equivalent data are available to cover the intended operation of the aeroplane including any diversion which may reasonably be expected. This shall include any conversion tables necessary to support operations where metric heights, altitudes and flight levels must be used

- e) Surfaces are available which permit a safe forced landing to be executed in the event of engine failure.

5.1.2.2 An operator shall ensure that operations are conducted in accordance with any restriction on the routes or the areas of operation, imposed by the CAAM.

5.2 Applicable to aeroplanes certificated in accordance with Parts IIIA and IIIB of CAD 8

5.2.1 The Standards contained in 5.2.2 to 5.2.11 inclusive are applicable to the large aeroplanes to which Parts IIIA and IIIB of Annex 8 are applicable.

Note.— The following Standards do not include quantitative specifications comparable to those found in national airworthiness codes. In accordance with 5.1.1, they are to be supplemented by national requirements prepared by Contracting States.

5.2.2 The level of performance defined by the appropriate parts of the comprehensive and detailed national code referred to in 5.1.1 for the aeroplanes designated in 5.2.1 shall be at least substantially equivalent to the overall level embodied in the Standards of this chapter.

Note.— Appendix 10 indicates the level of performance intended by the Standards of this chapter.

5.2.3 An aeroplane shall be operated in compliance with the terms of its certificate of airworthiness and within the approved operating limitations contained in its flight manual.

5.2.4 The State of Registry shall take such precautions as are reasonably possible to ensure that the general level of safety contemplated by these provisions is maintained under all expected operating conditions, including those not covered specifically by the provisions of this chapter.

5.2.5 A flight shall not be commenced unless the performance information provided in the flight manual, supplemented as necessary with other data acceptable to the CAAM, indicates that the Standards of 5.2.6 to 5.2.11 can be complied with for the flight to be undertaken

5.2.6 In applying the Standards of this chapter, account shall be taken of all factors that significantly affect the performance of the aeroplane, including but not limited to: the mass of the aeroplane, the operating procedures, the pressure-altitude appropriate to the elevation of the aerodrome, the runway slope, the ambient temperature, the wind, and surface conditions of the runway at the expected time of use, i.e. presence of snow, slush, water, and/or ice for landplanes. Such factors shall be taken into account directly as operational parameters or indirectly by means of allowances or margins, which may be provided in the scheduling of performance data or in the comprehensive and detailed code of performance in accordance with which the aeroplane is being operated.

Note.— Guidelines for using runway surface condition information on board aircraft in accordance with 4.4.11 are contained in the Aeroplane Performance Manual (ICAO Doc 10064).

5.2.7 Mass limitations

a) The mass of the aeroplane at the start of take-off shall not exceed the mass at which 5.2.8 is complied with, or the mass at which 5.2.9, 5.2.10 and 5.2.11 are complied with, allowing for expected reductions in mass as the flight proceeds, and for such fuel jettisoning as is envisaged in applying 5.2.9 and 5.2.10 and, in respect of alternate aerodromes, 5.2.7 c) and 5.2.11.

b) In no case shall the mass at the start of take-off exceed the maximum take-off mass specified in the flight manual for the pressure-altitude appropriate to the elevation of the aerodrome, and, if used as a parameter to determine the maximum take-off mass, any other local atmospheric condition.

- c) In no case shall the estimated mass for the expected time of landing at the aerodrome of intended landing and at any destination alternate aerodrome, exceed the maximum landing mass specified in the flight manual for the pressure-altitude appropriate to the elevation of those aerodromes, and if used as a parameter to determine the maximum landing mass, any other local atmospheric condition.
- d) In no case shall the mass at the start of take-off, or at the expected time of landing at the aerodrome of intended landing and at any destination alternate aerodrome, exceed the relevant maximum masses at which compliance has been demonstrated with the applicable noise certification Standards in Annex 16, Volume I, unless otherwise authorized in exceptional circumstances for a certain aerodrome or a runway where there is no noise disturbance problem, by the competent authority of the State in which the aerodrome is situated.

5.2.8 Take-off. The aeroplane shall be able, in the event of a critical engine failing, or for other reasons, at any point in the take-off, either to discontinue the take-off and stop within the accelerate-stop distance available, or to continue the take-off and clear all obstacles along the flight path by an adequate vertical or horizontal distance until the aeroplane is in a position to comply with 5.2.9. When determining the resulting take-off obstacle accountability area, the operating conditions, such as the crosswind component and navigation accuracy, must be taken into account.

Note.— Appendix 10 states the vertical and horizontal distances that are considered adequate to show compliance with this Standard.

5.2.8.1 In determining the length of the runway available, account shall be taken of the loss, if any, of runway length due to alignment of the aeroplane prior to take-off.

5.2.9 En route — one engine inoperative. The aeroplane shall be able, in the event of the critical engine becoming inoperative at any point along the route or planned diversions therefrom, to continue the flight to an aerodrome at which the Standard of 5.2.11 can be met, without flying below the minimum flight altitude at any point.

5.2.10 En route — two engines inoperative. In the case of aeroplanes having three or more engines, on any part of a route where the location of en-route alternate aerodromes and the total duration of the flight are such that the probability of a second engine becoming inoperative must be allowed for if the general level of safety implied by the Standards of this chapter is to be maintained, the aeroplane shall be able, in the event of any two engines becoming inoperative, to continue the flight to an en-route alternate aerodrome and land.

5.2.11 Landing. The aeroplane shall, at the aerodrome of intended landing and at any alternate aerodrome, after clearing all obstacles in the approach path by a safe margin, be able to land, with assurance that it can come to a stop or, for a seaplane, to a satisfactorily low speed, within the landing distance available. Allowance shall be made for expected variations in the approach and landing

techniques, if such allowance has not been made in the scheduling of performance data.

Note.— Guidelines on appropriate margins for the “at time of landing” distance assessment is contained in the Aeroplane Performance Manual (Doc 10064).

5.3 Obstacle data

5.3.1 Obstacle data shall be provided to enable the operator to develop procedures to comply with 5.2.9.

Note.— See CAD 4 and CAD 15, Chapter 5 and Appendix 1 and the Procedures for Air Navigation Services — Aeronautical Information Management (PANS-AIM), Chapter 5 for methods of presentation of certain obstacle data.

5.3.2 The operator shall take account of charting accuracy when assessing compliance with 5.2.

5.4 Additional requirements for operations of single-engine turbine-powered aeroplanes at night and/or in instrument meteorological conditions (IMC)

5.4.1 Except where approved by the CAAM, an operator shall not operate a single-engine turbine powered aeroplane:

- a) At night and/or
- b) in Instrument Meteorological Conditions (IMC) except under Special Visual Flight Rules.

5.4.2 To be approved in accordance with 5.4.1, the operator shall ensure that the airworthiness certification of the aeroplane is appropriate and that the overall level of safety intended by the provisions of CAD 6 Part 1 and CAD 8 is provided by:

- a) The reliability of the turbine engine;
- b) The operator’s maintenance procedures, operating practices, flight dispatch procedures and crew training programmes;
- c) Equipment and other requirements provided in accordance with Appendix 3 to this CAD; and
- d) Shall have an engine trend monitoring system.

5.4.3 Aeroplanes, for which the individual certificate of airworthiness is first issued on or after 1 January 2005, shall have an automatic trend monitoring system.



INTENTIONALLY LEFT BLANK

6 Aeroplane instruments, equipment and flight documents

6.1 General

6.1.1 In addition to the minimum equipment necessary for the issuance of a certificate of airworthiness, the instruments, equipment and flight documents prescribed in the following paragraphs shall be installed or carried, as appropriate, in aeroplanes according to the aeroplane used and to the circumstances under which the flight is to be conducted. The prescribed instruments and equipment, including their installation, requires approval or acceptance from the CAAM.

6.1.2 Documents to be carried.

6.1.2.1 An aeroplane shall carry a certified true copy of the air operator certificate, and a copy of the operations specifications relevant to the aeroplane type, issued in conjunction with the certificate. When the certificate and the associated operations specifications are issued by other States in a language other than English, an English translation shall be included.

6.1.2.2 An operator shall ensure that the following are carried on each flight:

- a) The Certificate of Registration.
- b) The Certificate of Airworthiness.
- c) The original or a copy of the Noise Certificate (if applicable), including an English translation, where one has been provided by the CAAM.
- d) The original or a certified true copy of the Air Operator Certificate and a copy of Operations Specification relevant to the aeroplane type, issued in conjunction with the certificate.
- e) The Aircraft Radio Station Licence.
- f) The original or a copy of the Insurance Certificate(s), which cover the aircraft, its crew, passengers and third-party liability clauses.

6.1.2.3 The AOC and the associated operations specifications issued to an air operator are also intended to provide a basis for another State to authorise operations in its territory by that air operator, provided that the requirements under which the certificate was issued were at least equal to the applicable Standards specified in this CAD.

6.1.2.4 Aircraft engaged in commercial operations are required by this CAD to carry a certified true copy of the AOC and a copy of the associated operations specifications relevant to the aircraft type.

6.1.2.5 The operations specifications associated with an AOC are an integral part of the authorisation under which an operator conducts operations.



- 6.1.2.6 The specifications identify the CAAM, the number of the associated AOC, the name of the operator, the date of issuance and the signature of the CAAM official responsible for its issuance and show the make, model and series, or master series, of the aircraft, the type of operation and the geographical areas in which operations are authorised.
- 6.1.2.7 The specifications cover all aspects of the operation and include special limitations and authorisations with criteria as appropriate.
- 6.1.2.8 There are several ways to certify a copy of the AOC. In any case, the certification statement shall attest that the copy is a true copy of the original, and shall be signed and display an official stamp or seal.
- 6.1.2.9 The certification statement shall be permanently affixed to the copy, either by placing it on the first page of the document itself or on each page of the document, or by attaching it to the entirety of it.
- 6.1.2.10 Additional Documents to be Carried.
- 6.1.2.10.1 An operator shall ensure that, in addition to the documents and manuals prescribed in 6.1.2.2, the following information and forms, relevant to the type and area of operation, are carried on each flight:
- a) The current parts of the Operations Manual relevant to the duties of the crew are carried on each flight.
 - b) Those parts of the Operations Manual which are required for the conduct of a flight are easily accessible to the crew on board the aeroplane.
 - c) The current Aeroplane Flight Manual is carried in the aeroplane unless the CAAM has accepted that the Operations Manual contains relevant information for that aeroplane.
 - d) Operational Flight Plan containing at least the information required in 4.3.3.1.1 Operational flight plan.
 - e) Operator's journey log book.
 - f) Details of the filed ATS flight plan.
 - g) Appropriate NOTAM/AIP/AIRAC/AIC/AIS briefing documentation.
 - h) Appropriate meteorological information.
 - i) Mass and balance documentation.
 - j) Notification of special categories of passenger such as security personnel, if not considered as crew, persons with disability, inadmissible passengers, deportees and persons in custody.

- k) Notification of special loads including dangerous goods including written information to the pilot-in-command.
- l) Current maps, charts and associated documents or equivalent data are available to cover the intended operation of the aeroplane including any diversion which may reasonably be expected. This shall include any conversion tables necessary to support operations where metric heights, altitudes and flight levels must be used.
- m) Any other documentation which may be required by the States concerned with this flight, such as cargo manifest, passenger manifest, navigation certificates etc; and
- n) Forms to comply with the reporting requirements of the CAAM and the operator.

6.1.2.10.2 The CAAM may permit the information detailed in the provision in subparagraph 6.1.2.10.1 above, or parts thereof, to be presented in a form other than on printed paper. An acceptable standard of accessibility, usability and reliability must be assured.

6.1.3 Minimum Equipment List (MEL).

6.1.3.1 The operator shall include in the OM a MEL, approved by the CAAM which will enable the pilot-in-command to determine whether a flight may be commenced or continued from any intermediate stop should any instrument, equipment or systems become inoperative.

6.1.3.2 The operator shall ensure that the MEL does not affect the aeroplane's compliance with the airworthiness requirements as applicable.

6.1.3.3 The MEL shall take into account the aeroplane types and variants operated and the type(s)/area(s) of operation.

6.1.3.4 The MEL must include the navigational equipment and take into account the required navigation performance for the route and area of operation.

6.1.3.5 An operator shall not operate an aeroplane other than in accordance with the MEL unless permitted by the CAAM. Any such permission will in no circumstances permit operation outside the constraints of the Master Minimum Equipment List (MMEL).

6.1.3.6 Non-Malaysian aeroplanes shall ensure that the MEL does not affect the aeroplane's compliance with the airworthiness requirements applicable in the State of Registry.

Note.— Attachment E of this CAD contains guidance on the minimum equipment list.

6.1.4 Aircraft Operating Manual (AOM).

- 6.1.4.1 The operator shall provide operations staff and flight crew with an AOM, for each aircraft type operated, containing the normal, abnormal and emergency procedures relating to the operation of the aircraft. The manual shall include details of the aircraft systems and of the checklists to be used. The design of the manual shall observe Human Factors principles.
- 6.1.5 Aeroplane operated under an Article 83*bis* agreement
- 6.1.5.1 An aeroplane, when operating under an Article 83*bis* agreement entered into between the State of Registry and State of the Operator, shall carry a certified true copy of the agreement summary, in either an electronic or hard copy format. When the summary is issued in a language other than English, an English shall be included.
- 6.1.5.2 The agreement summary of an Article 83*bis* agreement shall be accessible to the CAAM inspector to determine which functions and duties are transferred under the agreement by the State of Registry to the State of the Operator, when conducting surveillance activities such as ramp checks.
- 6.1.6 Operations Manual (OM).
- 6.1.6.1 The operations manual is the means by which the applicant intends to control all aspects of the intended operation.

6.2 All aeroplanes on all flights

- 6.2.1 Aircraft Instruments.
- 6.2.1.1 An aeroplane shall be equipped with instruments which will enable the flight crew to control the flight path of the aeroplane, carry out any required procedural manoeuvres and observe the operating limitations of the aeroplane in the expected operating conditions.
- 6.2.1.2 The instruments and equipment required for the flight to be conducted shall be available and be in operable condition except as provided in the MEL.
- 6.2.2 An operator shall ensure that a flight does not commence unless the instruments and equipment required under this CAD are:
- a) Installed as such that the failure of any single unit required for either communications or navigation purposes or both will not result in the failure of another unit required for communications or navigation purposes.
 - b) Approved, except as specified in the provision of 6.2.2.1, and installed in accordance with the requirements applicable to them, including the minimum performance standard and the operational and airworthiness requirements; and

- c) In operable condition for the kind of operation being conducted except as provided in the MEL.

6.2.2.1 The following items are not required to have an equipment approval:

- a) Fuses.
- b) Electric torches.
- c) Accurate time piece.
- d) Chart holder.
- e) First-aid kits.
- f) Emergency medical kit.
- g) Megaphones.
- h) Survival and pyrotechnic signalling equipment.
- i) Sea anchors and equipment for mooring, anchoring or manoeuvring seaplanes and amphibians on water.
- j) Child restraint devices.

6.2.3 Medical Supplies

6.2.3.1 For aeroplanes required to carry cabin crew as part of the operating crew, the operator shall carry one universal precaution kit (two for aeroplanes authorised to carry more than 250 passengers) for the use of cabin crew members in managing incidents of ill health associated with a case of suspected communicable disease, or in the case of illness involving contact with body fluids.

6.2.3.2 An operator shall not operate an aeroplane with a maximum approved passenger seating configuration of more than 30 seats unless it is equipped with an emergency medical kit if any point on the planned route is more than 60 minutes flying time (at normal cruising speed) from an aerodrome at which qualified medical assistance could be expected to be available.

6.2.3.3 The emergency medical kit must be dust and moisture proof, kept up to date and shall be carried under security conditions, where practicable, on the flight deck.

6.2.3.4 An operator shall not operate an aeroplane unless it is equipped with first-aid kits, readily accessible for use, to the following scale:

Passenger	First-aid kits
0 – 100	1
101 – 200	2

201 – 300	3
301 – 400	4
401 – 500	5
More than 500	6

- 6.2.3.5 An operator shall ensure that emergency medical and first aid kits are:
- a) Inspected periodically to confirm, to the extent possible, that the contents are maintained in the condition necessary for their intended use.
 - b) Replenished at regular intervals, in accordance with instructions contained on their labels, or as circumstances warrant.

Note. – Guidance on the contents of emergency medical and first aid kits is contained in Attachment A of this CAD.

6.2.4 Hand Fire Extinguishers.

- 6.2.4.1 The number and location of hand fire extinguishers shall be such as to provide adequate availability for use, account being taken of the number and size of the passenger compartments, the need to minimise the hazard of toxic gas concentrations and the location of toilets, galleys etc.
- 6.2.4.2 These considerations may result in the number being greater than the minimum prescribed.
- 6.2.4.3 There shall be at least one fire extinguisher suitable for both flammable fluid and electrical equipment fires installed on the flight deck.
- 6.2.4.4 Additional extinguishers may be required for the protection of other compartments accessible to the crew in flight.
- 6.2.4.5 Dry chemical fire extinguishers shall not be used on the flight deck, or in any compartment not separated by a partition from the flight deck, because of the adverse effect on vision during discharge and, if non-conductive, interference with electrical contacts by the chemical residues.
- 6.2.4.6 Where only one hand fire extinguisher is required in the passenger compartments it shall be located near the cabin crew member’s station, where provided.
- 6.2.4.7 Where two or more hand fire extinguishers are required in the passenger compartments and their location is not otherwise dictated by consideration of paragraph 6.2.4.1 above, an extinguisher shall be located near each end of the cabin with the remainder distributed throughout the cabin as evenly as is practicable.

- 6.2.4.8 Unless an extinguisher is clearly visible, its location shall be indicated by a placard or sign. Appropriate symbols may be used to supplement such a placard or sign.
- 6.2.4.9 An operator shall not operate an aeroplane unless hand fire extinguishers are provided for use in crew, passenger and, as applicable, cargo compartments and galleys in accordance with the following:
- a) The type and quantity of extinguishing agent must be suitable for the kinds of fires likely to occur in the compartment where the extinguisher is intended to be used and, for personnel compartments, must minimise the hazard of toxic gas concentration.
 - b) At least one hand fire extinguisher, containing Halon 1211 (bromochlorodifluoromethane, CBrClF₂), or equivalent as the extinguishing agent, must be conveniently located on the flight deck for use by the flight crew.
 - c) At least one hand fire extinguisher must be located in, or readily accessible for use in, each galley not located on the main passenger deck.
 - d) At least one readily accessible hand fire extinguisher must be available for use in each Class A or Class B cargo or baggage compartment and in each Class E cargo compartment that is accessible to crew members in flight.
 - e) At least the following number of hand fire extinguishers shall be conveniently located in the passenger compartment(s).

Maximum approved passenger seating configuration	Number of Extinguishers
7 to 30	1
31 to 60	2
61 to 200	3
201 to 300	4
301 to 400	5
401 to 500	6
501 to 600	7
601 or more	8

- 6.2.4.10 When two or more extinguishers are required, they must be evenly distributed in the passenger compartment.
- 6.2.4.11 Any agent used in a built-in fire extinguisher for each lavatory disposal receptacle for towels, paper or waste in an aeroplane for which the individual certificate of airworthiness is first issued on or after 31 December 2011 and any extinguishing agent used in a portable fire extinguisher in an aeroplane for which the individual certificate of airworthiness is first issued on or after 31 December 2018 shall:

- a) meet the applicable minimum performance requirements of the CAAM; and
- b) not be of a type listed in the 1987 *Montreal Protocol on Substances that Deplete the Ozone Layer as it appears in the Eighth Edition of the Handbook for the Montreal Protocol on Substances that Deplete the Ozone Layer, Annex A, Group II.*

6.2.5 Aeroplanes with a maximum approved passenger seating configuration of more than 60 and carrying at least one passenger shall be equipped with the following quantities of portable battery-powered megaphones readily accessible for use by crew members during an emergency evacuation:

- a) For each passenger deck:

Passenger seating configuration	Number of megaphones
61 to 99	1
100 or more	2

- b) For aeroplanes with more than one passenger deck, in all cases when the total passenger seating configuration is more than 60, at least one megaphone.

6.2.6 Seats, Seat Belts and Safety Harness.

6.2.6.1 An operator shall establish procedures to ensure that passengers are seated where, in the event that an emergency evacuation is required, they may best assist and not hinder evacuation from the aeroplane.

6.2.6.1.1 Passenger Seating

- a) The following categories of passengers are among those who shall not be allocated to, or directed to seats which permit direct access to emergency exits:
 - 1) Passengers suffering from obvious physical, or mental disability to the extent that they would have difficulty in moving quickly if asked to do so.
 - 2) Passengers who are either substantially blind or substantially deaf to the extent that they might not readily assimilate printed or verbal instructions given.
 - 3) Passengers who because of age or sickness are so frail that they have difficulty in moving quickly.
 - 4) Passengers who are so obese that they would have difficulty in moving quickly or reaching and passing through the adjacent emergency exit.

- 5) Children (whether accompanied or not) and infants.
- 6) Deportees, inadmissible passengers or persons in custody.
- 7) Passengers with animals.

Note: “Direct access” means a seat from which a passenger can proceed directly to the exit without entering an aisle or passing around an obstruction.

- 6.2.6.2 During take-off and landing, and whenever deemed necessary by the pilot-in-command in the interest of safety, each crew member shall be properly secured by all safety belts and harnesses provided.
- 6.2.6.3 During other phases of the flight each flight crew member on the flight deck shall keep his safety belt fastened while at his station.
- 6.2.6.4 Before take-off and landing, and during taxiing, and whenever deemed necessary in the interest of safety, the pilot-in-command shall ensure that each passenger on board occupies a seat or berth with his safety belt, or harness where provided, properly secured.
- 6.2.6.5 An operator shall make provision for, and the pilot-in-command shall ensure that multiple occupancy of aeroplane seats may only be allowed on specified seats and does not occur other than by one adult and one infant who is properly secured by a supplementary loop belt or other restraint device.
- 6.2.6.6 Aeroplanes shall be equipped with:
- a) A seat or berth for each person on board who is aged 24 months or more,
 - b) A seat belt on each passenger seat and restraining belts for each berth except as specified in (c),
 - c) A seat belt with upper torso restraint system on each passenger seat and restraining belts on each berth in the case of aeroplanes with an maximum certificated take-off mass of 5 700 kg or less and with a maximum approved passenger seating configuration of nine or less, having an individual CofA first issued on or after 8 April 2015,
 - d) A child restraint device (CRD) for each person on board younger than 24 months,
 - e) A seat belt with upper torso restraint system incorporating a device that will automatically restrain the occupant’s torso in the event of rapid deceleration:
 - 1) on each flight crew seat and on any seat alongside a pilot’s seat,
 - 2) on each observer seat located in the flight crew compartment,
 - 3) A seat belt with upper torso restraint system on each seat for the minimum required cabin crew.

- f) A safety belt with harness for each cabin crew seat and observer's seats. However, this requirement does not preclude use of passenger seats by cabin crew members carried in excess of the required cabin crew complement, and
- g) Seats for cabin crew members located near required floor level emergency exits except that, if the emergency evacuation of passengers would be enhanced by seating cabin crew members elsewhere, other locations are acceptable. The seats shall be forward or rearward facing within 15° of the longitudinal axis of the aeroplane.

6.2.6.6.1 The safety harness for each pilot seat should incorporate a device to prevent a suddenly incapacitated pilot from interfering with the flight controls.

6.2.6.7 A seat belt with upper torso restraint system shall have:

- a) a single point release;
- b) on the seats for the minimum required cabin crew, two shoulder straps and a seat belt that may be used independently; and
- c) on flight crew members' seats and on any seat alongside a pilot's seat, either of the following:
 - 1) two shoulder straps and a seat belt that may be used independently;
 - 2) a diagonal shoulder strap and a seat belt that may be used independently for aeroplanes with a maximum certificated take-off mass of 5700kg or less and with a maximum approved passenger seating configuration of nine or less.

6.2.7 Child Restraint Device (CRD).

6.2.7.1 A child restraint device (CRD) is considered to be acceptable if it is a supplementary loop belt manufactured with the same techniques and the same materials of the approved safety belts.

6.2.8 An aeroplane shall be equipped with the means of ensuring that the following information and instructions are conveyed to passengers:

- a) When seat belts are to be fastened,
- b) When and how oxygen equipment is to be used if the carriage of oxygen is required,
- c) Restrictions on smoking,
- d) Location and use of life jackets or equivalent individual floatation device where their carriage is required, and
- e) Location and method of opening emergency exits.

6.2.9 Spare Fuses.

- a) An operator shall not operate an aeroplane in which fuses are used unless there are spare fuses available for use in flight equal to at least 10% of the number of fuses of each rating or three of each rating whichever is the greater.

6.2.10 Marking of break-in points

6.2.10.1 If the CAAM requires an aeroplane to be marked with break-in points, the operator shall ensure that, if areas of the fuselage suitable for break-in by rescue crews in emergency are marked on an aeroplane, such areas shall be marked as shown below (see figure following).

6.2.10.2 In addition to Regulation 96 (1) of the MCAR 2016, the colour of the markings shall be red or yellow, and if necessary, they shall be outlined in white to contrast with the background.

6.2.10.3 If the corner markings are more than 2 metres apart, intermediate lines 9 cm x 3 cm shall be inserted so that there is no more than 2 metres between adjacent marks.

Note. – This Standard does not require any aeroplane to have break-in areas.

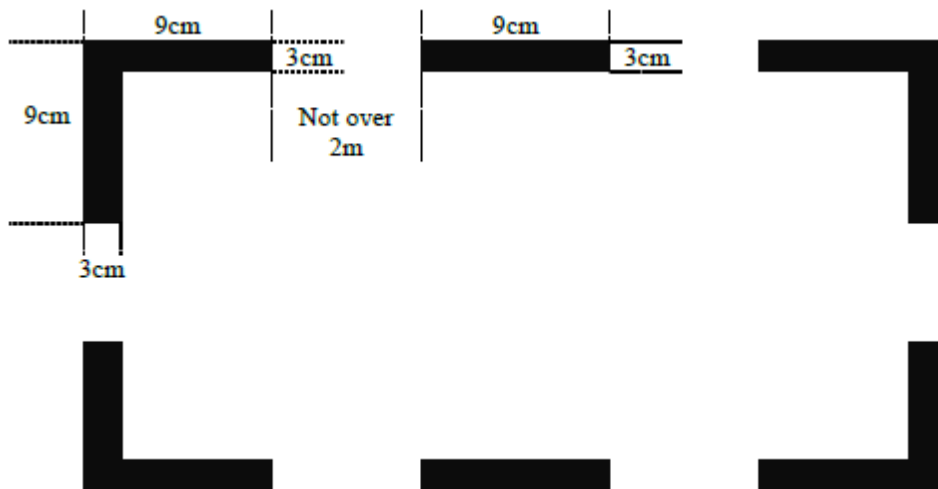

MARKING OF BREAK-IN POINTS (see 6.2.10)

6.3 Flight recorders

Note 1.— Crash-protected flight recorders comprise one or more of the following systems:

- a flight data recorder (FDR),
- a cockpit voice recorder (CVR),
- an airborne image recorder (AIR),

- a data link recorder (DLR).

Image and data link information may be recorded on either the CVR or the FDR.

Note 2.— Lightweight flight recorders comprise one or more of the following systems:

- an aircraft data recording system (ADRS),
- a cockpit audio recording system (CARS),
- an airborne image recording system (AIRS),
- a data link recording system (DLRS).

Image and data link information may be recorded on either the CARS or the ADRS.

Note 3.— Detailed requirements on flight recorders are contained in Appendix 8.

Note 4.— For aeroplanes for which the application for type certification is submitted to a Contracting State before 1 January 2016, specifications applicable to crash-protected flight recorders may be found in EUROCAE ED-112, ED-56A, ED-55, Minimum Operational Performance Specifications (MOPS), or earlier equivalent documents.

Note 5.— For aeroplanes for which the application for type certification is submitted to a Contracting State on or after 1 January 2016, specifications applicable to crash-protected flight recorders may be found in EUROCAE ED-112A, Minimum Operational Performance Specification (MOPS), or equivalent documents.

Note 6.— Specifications applicable to lightweight flight recorders may be found in EUROCAE ED-155, Minimum Operational Performance Specification (MOPS), or equivalent documents.

Note 7.— As of 7 November 2019, Chapter 3 contains requirements for States regarding the use of voice, image and/or data recordings and transcripts.

6.3.1 Flight data recorders and aircraft data recording systems

Note.—Parameters to be recorded are listed in Tables A8-1 and A8-3 of Appendix 8.

6.3.1.1 Applicability

6.3.1.1.1 All turbine-engined aeroplanes of a maximum certificated take-off mass of 5700 kg or less for which the application for type certification is submitted to a Contracting State on or after 1 January 2016 shall be equipped with:

- a) an FDR which shall record at least the first 16 parameters listed in Table A8-1 of Appendix 8; or
- b) a Class C AIR or AIRS which shall record at least the flight path and speed parameters displayed to the pilot(s), as defined in 2.2.3 of Appendix 8; or
- c) an ADRS which shall record at least the first 7 parameters listed in Table A8-3 of Appendix 8.

Note 1.— “The application for type certification is submitted to a Contracting State” refers to the date of application of the original “Type Certificate” for the aeroplane type, not the date of certification of particular aeroplane variants or derivative models.

Note 2.— AIR or AIRS classification is defined in 6.2 of Appendix 8.

- 6.3.1.1.2 All turbine-engined aeroplanes of a maximum certificated take-off mass of 5700 kg or less for which the individual certificate of airworthiness is first issued on or after 1 January 2016 should be equipped with:
- a) an FDR which should record at least the first 16 parameters listed in Table A8-1 of Appendix 8; or
 - b) a Class C AIR or AIRS which should record at least the flight path and speed parameters displayed to the pilot(s), as defined in 2.2.3 of Appendix 8; or
 - c) an ADRS which should record at least the first 7 parameters listed in Table A8-3 of Appendix 8.
- 6.3.1.1.3 All aeroplanes of a maximum certificated take-off mass of over 27 000 kg for which the individual certificate of airworthiness is first issued on or after 1 January 1989 shall be equipped with an FDR which shall record at least the first 32 parameters listed in Table A8-1 of Appendix 8.
- 6.3.1.1.4 All aeroplanes of a maximum certificated take-off mass of over 5 700 kg, up to and including 27 000 kg, for which the individual certificate of airworthiness is first issued on or after 1 January 1989, shall be equipped with an FDR which shall record at least the first 16 parameters listed in Table A8-1 of Appendix 8.
- 6.3.1.1.5 All multi-engined turbine-engined aeroplanes of a maximum certificated take-off mass of 5 700 kg or less for which the individual certificate of airworthiness is first issued on or after 1 January 1990 should be equipped with an FDR which should record at least the first 16 parameters listed in Table A8-1 of Appendix 8.
- 6.3.1.1.6 All turbine-engined aeroplanes, for which the individual certificate of airworthiness was first issued before 1 January 1989, with a maximum certificated take-off mass of over 5 700 kg, except those in 6.3.1.1.8, shall be equipped with an FDR which shall record at least the first 5 parameters listed in Table A8-1 of Appendix 8.
- 6.3.1.1.7 All turbine-engined aeroplanes, for which the individual certificate of airworthiness was first issued on or after 1 January 1987 but before 1 January 1989, with a maximum certificated take-off mass of over 5 700 kg, except those in 6.3.1.1.8, should be equipped with an FDR which should record at least the first 9 parameters listed in Table A8-1 of Appendix 8.

- 6.3.1.1.8 All turbine-engined aeroplanes, for which the individual certificate of airworthiness was first issued on or after 1 January 1987 but before 1 January 1989, with a maximum certificated take-off mass of over 27 000 kg that are of types of which the prototype was certificated by the appropriate national authority after 30 September 1969 shall be equipped with an FDR which shall record at least the first 16 parameters listed in Table A8-1 of Appendix 8.
- 6.3.1.1.9 All turbine-engined aeroplanes, for which the individual certificate of airworthiness was first issued before 1 January 1987, with a maximum certificated take-off mass of over 27 000 kg that are of types of which the prototype was certificated by the appropriate national authority after 30 September 1969 should be equipped with an FDR which should record, in addition to the first 5 parameters listed in Table A8-1 of Appendix 8, such additional parameters as are necessary to meet the objectives of determining:
- a) the attitude of the aeroplane in achieving its flight path; and
 - b) the basic forces acting upon the aeroplane resulting in the achieved flight path and the origin of such basic forces.
- 6.3.1.1.10 All aeroplanes of a maximum certificated take-off mass of over 5 700 kg for which the individual certificate of airworthiness is first issued after 1 January 2005 shall be equipped with an FDR which shall record at least the first 78 parameters listed in Table A8-1 of Appendix 8.
- 6.3.1.1.11 All aeroplanes of a maximum certificated take-off mass of over 5 700 kg for which the application for type certification is submitted to a Contracting State on or after 1 January 2023 shall be equipped with an FDR capable of recording at least the 82 parameters listed in Table A8-1 of Appendix 8.
- 6.3.1.1.12 All aeroplanes of a maximum certificated take-off mass of over 5 700 kg for which the individual certificate of airworthiness is first issued on or after 1 January 2023 shall be equipped with an FDR capable of recording at least the 82 parameters listed in Table A8-1 of Appendix 8.
- 6.3.1.2 Recording technology
- 6.3.1.2.1 FDRs or ADRS shall not use engraving metal foil, frequency modulation (FM), photographic film or magnetic tape.
- 6.3.1.3 Duration
- 6.3.1.3.1 All FDRs shall retain the information recorded during at least the last 25 hours of their operation, with the exception of those installed on aeroplanes referenced in 6.3.1.1.5 for which the FDR shall retain the information

recorded during at least the last 30 minutes of its operation, and, in addition, sufficient information from the preceding take-off for calibration purposes.

6.3.2 Cockpit voice recorders and cockpit audio recording systems

6.3.2.1 Applicability

6.3.2.1.1 All turbine-engined aeroplanes of a maximum certificated take-off mass of over 2 250 kg, up to and including 5 700 kg, for which the application for type certification is submitted to a Contracting State on or after 1 January 2016 and required to be operated by more than one pilot shall be equipped with either a CVR or a CARS.

6.3.2.1.2 All turbine-engined aeroplanes of a maximum certificated take-off mass of 5 700 kg or less for which the individual certificate of airworthiness is first issued on or after 1 January 2016 and required to be operated by more than one pilot should be equipped with either a CVR or a CARS.

6.3.2.1.3 All aeroplanes of a maximum certificated take-off mass of over 5 700 kg for which the individual certificate of airworthiness is first issued on or after 1 January 1987 shall be equipped with a CVR.

6.3.2.1.4 All turbine-engined aeroplanes, for which the individual certificate of airworthiness was first issued before 1 January 1987, with a maximum certificated take-off mass of over 27 000 kg that are of types of which the prototype was certificated by the appropriate national authority after 30 September 1969 shall be equipped with a CVR.

6.3.2.1.5 All turbine-engined aeroplanes, for which the individual certificate of airworthiness was first issued before 1 January 1987, with a maximum certificated take-off mass of over 5 700 kg up to and including 27 000 kg that are of types of which the prototype was certificated by the appropriate national authority after 30 September 1969 should be equipped with a CVR.

6.3.2.2 Recording technology

6.3.2.2.1 CVRs and CARS shall not use magnetic tape or wire.

6.3.2.3 Duration

6.3.2.3.1 All CVRs shall retain the information recorded during at least the last 2 hours of their operation.

6.3.2.3.2 All aeroplanes of a maximum certificated take-off mass of over 27 000 kg for which the individual certificate of airworthiness is first issued on or after 1 January 2022 shall be equipped with a CVR which shall retain the information recorded during at least the last 25 hours of its operation.

- 6.3.2.3.3 All aeroplanes that are required to be equipped with CARS, and for which the individual certificate of airworthiness is first issued on or after 1 January 2025, shall be equipped with a CARS which shall retain the information recorded during at least the last two hours of their operation.
- 6.3.2.4 Cockpit voice recorder alternate power source
- 6.3.2.4.1 An alternate power source shall automatically engage and provide 10 minutes, plus or minus one minute, of operation whenever aeroplane power to the recorder ceases, either by normal shutdown or by any other loss of power. The alternate power source shall power the CVR and its associated cockpit area microphone components. The CVR shall be located as close as practicable to the alternate power source.
- Note 1.— “Alternate” means separate from the power source that normally provides power to the CVR. The use of aeroplane batteries or other power sources is acceptable provided that the requirements above are met and electrical power to essential and critical loads is not compromised.*
- Note 2.— When the CVR function is combined with other recording functions within the same unit, powering the other functions is allowed.*
- 6.3.2.4.2 All aeroplanes of a maximum certificated take-off mass of over 27 000 kg for which the application for type certification is submitted to a Contracting State on or after 1 January 2018 shall be provided with an alternate power source, as defined in 6.3.2.4.1, that powers the forward CVR in the case of combination recorders
- 6.3.2.4.3 All aeroplanes of a maximum certificated take-off mass of over 27 000 kg for which the individual certificate of airworthiness is first issued on or after 1 January 2018 should be provided with an alternate power source, as defined in 6.3.2.4.1, that powers at least one CVR.
- 6.3.3 Data link recorders
- 6.3.3.1 Applicability
- 6.3.3.1.1 All aeroplanes for which the individual certificate of airworthiness is first issued on or after 1 January 2016, which utilize any of the data link communications applications listed in 5.1.2 of Appendix 8 and are required to carry a CVR, shall record on a crash-protected flight recorder the data link communications messages.
- 6.3.3.1.2 All aeroplanes which are modified on or after 1 January 2016 to install and utilize any of the data link communications applications listed in 5.1.2 of Appendix 8 and are required to carry a CVR, shall record on a crash-protected flight recorder the data link communications messages.
- Note.— A Class B AIR could be a means for recording data link communications applications messages to and from the aeroplanes where*

it is not practical or is prohibitively expensive to record those data link communications applications messages on FDR or CVR.

6.3.3.2 Duration

6.3.3.2.1 The minimum recording duration shall be equal to the duration of the CVR.

6.3.3.3 Correlation

6.3.3.3.1 Data link recording shall be able to be correlated to the recorded cockpit audio.

6.3.4 Flight crew-machine interface recordings

6.3.4.1 Applicability

6.3.4.1.1 All aeroplanes of a maximum take-off mass of over 27 000 kg for which the application for type certification is submitted to a Contracting State on or after 1 January 2023 shall be equipped with a crash-protected flight recorder which shall record the information displayed to the flight crew from electronic displays, as well as the operation of switches and selectors by the flight crew as defined in Appendix 8.

6.3.4.1.2 All aeroplanes of a maximum take-off mass of over 5 700 kg, up to and including 27 000 kg, for which the application for type certification is submitted to a Contracting State on or after 1 January 2023 should be equipped with a crash-protected flight recorder which should record the information displayed to the flight crew from electronic displays, as well as the operation of switches and selectors by the flight crew, as defined in Appendix 8.

6.3.4.2 Duration

6.3.4.2.1 The minimum flight crew-machine interface recording duration shall be at least for the last two hours.

6.3.4.3 Correlation

6.3.4.3.1 Flight crew-machine interface recordings shall be able to be correlated to the recorded cockpit audio.

6.3.5 Flight recorders — general

6.3.5.1 Construction and installation

6.3.5.1.1 Flight recorders shall be constructed, located and installed so as to provide maximum practical protection for the recordings in order that the recorded information may be preserved, recovered and transcribed. Flight recorders shall meet the prescribed crashworthiness and fire protection specifications.

6.3.5.2 Operation

6.3.5.2.1 Flight recorders shall not be switched off during flight time.

6.3.5.2.2 To preserve flight recorder records, flight recorders shall be deactivated upon completion of flight time following an accident or incident. The flight recorders shall not be reactivated before their disposition as determined in accordance with Annex 13.

Note 1.— The need for removal of the flight recorder records from the aircraft will be determined by the investigation authority in the State conducting the investigation with due regard to the seriousness of an occurrence and the circumstances, including the impact on the operation.

Note 2.— The operator's responsibilities regarding the retention of flight recorder records are contained in 11.6.

6.3.5.3 Continued serviceability

6.3.5.3.1 Operational checks and evaluations of recordings from the flight recorder systems shall be conducted to ensure the continued serviceability of the recorders.

Note.— Procedures for the inspections of the flight recorder systems are given in Appendix 8.

6.3.5.4 Flight recorder electronic documentation

6.3.5.4.1 The documentation requirement concerning FDR and ADRS parameters provided by operators to accident investigation authorities should be in electronic format and take account of industry specifications.

Note.— Industry specification for documentation concerning flight recorder parameters may be found in the ARINC 647A, Flight Recorder Electronic Documentation, or equivalent document.

6.3.5.5 Combination recorders

6.3.5.5.1 All aeroplanes of a maximum certificated take-off mass of over 5 700 kg for which the application for type certification is submitted to a Contracting State on or after 1 January 2016, and which are required to be equipped with both a CVR and an FDR, should be equipped with two combination recorders (FDR/CVR).

6.3.5.5.2 All aeroplanes of a maximum certificated take-off mass of over 15 000 kg for which the application for type certification is submitted to a Contracting State on or after 1 January 2016, and which are required to be equipped with both a CVR and an FDR, shall be equipped with two combination recorders (FDR/CVR). One recorder shall be located as close to the cockpit as practicable and the other recorder located as far aft as practicable.

- 6.3.5.5.3 All aeroplanes of a maximum certificated take-off mass over 5700 kg, required to be equipped with an FDR and a CVR, may alternatively be equipped with two combination recorders (FDR/CVR).

Note.— The requirement of 6.3.5.4 may be satisfied by equipping the aeroplanes with two combination recorders (one forward and one aft) or separate devices.

- 6.3.5.5.4 All multi-engined turbine-powered aeroplanes of a maximum certificated take-off mass of 5700 kg or less, required to be equipped with an FDR and/or a CVR, may alternatively be equipped with one combination recorder (FDR/CVR).

6.3.6 Flight recorder data recovery

- 6.3.6.1 All aeroplanes of a maximum certificated take-off mass of over 27 000 kg and authorized to carry more than nineteen passengers for which the application for type certification is submitted to a Contracting State on or after 1 January 2021, shall be equipped with a means approved by the CAAM, to recover flight recorder data and make it available in a timely manner.

- 6.3.6.2 In approving the means to make flight recorder data available in a timely manner, the CAAM takes into account the following:

- a) the capabilities of the operator;
- b) overall capability of the aeroplane and its systems as certified by the State of Design;
- c) the reliability of the means to recover the appropriate CVR channels and appropriate FDR data; and
- d) specific mitigation measures.

Note.— Guidance on approving the means to make flight recorder data available in a timely manner is contained in the Manual on Location of Aircraft in Distress and Flight Recorder Data Recovery (Doc 10054).

6.4 All aeroplanes operated as VFR flights

- 6.4.1 Aeroplanes operated under VFR by day shall be equipped with the following equipment, available at the pilot's station:

- 6.4.1.1 A means of measuring and displaying:

- a) Magnetic heading.
- b) Time in hours, minute, and seconds.
- c) Barometric altitude.
- d) Indicated airspeed.

- e) Vertical speed.
- f) Turn and slip.
- g) Attitude.
- h) Heading.
- i) Outside air temperature.
- j) Mach number whenever speed limitations are expressed in terms of mach number.

6.4.1.2 A means of indicating when the supply of power to the required flight instruments is not adequate.

6.4.2 Whenever two pilots are required for the operation, an additional separate means of displaying the following shall be available for the second pilot:

- a) Barometric altitude;
- b) Indicated airspeed;
- c) Vertical speed;
- d) Turn and slip;
- e) Attitude; and
- f) Heading.

6.4.3 A means for preventing malfunction of the airspeed indicating systems due to condensation or icing shall be available for:

- a) aeroplanes with an maximum certificated take-off mass of more than 5 700 kg or a maximum approved passenger seating configuration of more than nine; and
- b) aeroplanes first issued with an individual C of A on or after 1 April 1999.

6.4.4 Single engine aeroplanes first issued with an individual C of A before 22 May 1995 are exempted from the requirements of paragraph 6.4.1.1 f), g), h), i) if the compliance would require retrofitting.

6.4.5 VFR flights which are operated as controlled flights shall be equipped in accordance with 6.9.

6.5 All aeroplanes on flights over water

6.5.1 The following aeroplanes shall be equipped with a life-jacket for each person on board or for each person on board younger than 24 months, an equivalent floatation device, stowed in a position that is readily accessible from the seat or berth of the person for whose use it is provided:

- a) landplanes operated over water at a distance of more than 50 NM from the shore or taking off or landing at an aerodrome where the take-off or approach path is so disposed over water that there would be a likelihood of a ditching; and
 - b) seaplanes operated over water.
- 6.5.2 Each life-jacket or equivalent individual flotation device shall be equipped with a means of electric illumination for the purpose of facilitating the location of persons.
- 6.5.3 Seaplanes operated over water shall be equipped with the following:
- a) a sea anchor and other equipment necessary to facilitate mooring, anchoring or manoeuvring the seaplane on water, appropriate to its size, mass and handling characteristics;
 - b) equipment for making the sound signals as prescribed in the International Regulations for Preventing Collisions at Sea, where applicable.
- 6.5.4 Aeroplanes operated over water at a distance away from land suitable for making an emergency landing, greater than that corresponding to:
- a) 120 minutes at cruising speed or 400 NM, whichever is the lesser, in the case of aeroplanes capable of continuing the flight to an aerodrome with the critical engine(s) becoming inoperative at any point along the route or planned diversions; or
 - b) for all other aeroplanes, 30 minutes at cruising speed or 100 NM, whichever is the lesser, shall be equipped with the equipment specified in 6.5.5 of this CAD.
- 6.5.5 Aeroplanes operated in accordance 6.5.4 of this CAD shall carry the following equipment:
- a) Life-rafts in sufficient numbers to carry all persons on board, stowed so as to facilitate their ready use in an emergency, and being of sufficient size to accommodate all the survivors in the event of a loss of one raft of the largest rated capacity;
 - b) a survivor locator light in each life-raft;
 - c) life-saving equipment to provide the means for sustaining life, as appropriate for the flight to be undertaken; and
 - d) at least two survival ELTs (ELT(S)).
 - e) signalling equipment to make the pyrotechnic distress signals described in CAD 2.
- 6.5.5.1 The following should be readily available with each life-raft:

- a) Means for maintaining buoyancy;
- b) A sea anchor;
- c) Life-lines and means of attaching one life-raft to another;
- d) Paddles for life-rafts with a capacity of six or less;
- e) Means of protecting the occupants from the elements;
- f) A water-resistant torch;
- g) 100 g of glucose tablets for each four, or fraction of four, persons that the life-raft is designed to carry;
- h) At least 2 litres of drinkable water provided in durable containers or means of making sea water drinkable or a combination of both; and
- i) First-aid equipment.

As practicable, items listed in 6.5.5.1 should be contained in a pack.

- 6.5.6 Aeroplanes operated in accordance with 6.5.4 with a maximum certificated take-off mass of more than 27 000 kg shall be installed with a securely attached underwater locating device that operates at a frequency of 8.8 kHz. This automatically activated underwater locating device shall operate for a minimum of 30 days and shall not be installed in wings or empennage.

6.6 All aeroplanes on flights over designated land areas

- 6.6.1 Aeroplanes operated over areas in which search and rescue would be especially difficult shall be equipped with:

- a) Signalling equipment to make the distress signals.
- b) At least one ELT.
- c) Additional survival equipment for the route to be flown taking account the number of persons on board.

- 6.6.1.1 The following survival equipment should be carried when required:

- a) 2 litres of drinkable water for each 50, or fraction of 50, persons on board provided in durable containers,
- b) One knife,
- c) First-aid equipment,
- d) One set of Air/Ground codes.

In addition, when polar conditions are expected, the following should be carried:

- a) a means for melting snow,

- b) one shovel and one ice saw,
- c) sleeping bags for use by 1/3 of all persons on board and space blankets for the remainder or space blankets for all passengers on board,
- d) 1 Arctic/Polar suit for each crew member carried.

6.6.1.2 If any item of equipment contained in the above list is already carried on board the aeroplane in accordance with another requirement, there is no need for this to be duplicated.

6.6.2 The additional survival equipment specified in paragraph 6.6.1 c) does not need to be carried when the aeroplane:

- a) Remains within a distance from an area where search and rescue is not especially difficult corresponding to:
 - 1) 120 minutes at one-engine-inoperative (OEI) cruising speed for aeroplanes capable of continuing the flight to an aerodrome with the critical engine(s) becoming inoperative at any point along the route or planned diversion routes, or
 - 2) 30 minutes at cruising speed for all other aeroplanes.
- b) remains within a distance no greater than that corresponding to 90 minutes at cruising speed from an area suitable for making an emergency landing, for aeroplanes certified in accordance with the applicable airworthiness standard.

6.7 All aeroplanes on high altitude flights

6.7.1 An aeroplane intended to be operated at flight altitudes above 10 000 ft in personnel compartments shall be equipped with oxygen storage and dispensing apparatus capable of storing and dispensing the oxygen supplies required in Table 1 of 4.3.9 of this CAD.

6.7.2 An aeroplane intended to be operated at flight altitudes above 10 000 ft but which is provided with means of maintaining cabin altitudes lower than 10 000 ft in personnel compartments shall be provided with oxygen storage and dispensing apparatus capable of storing and dispensing the oxygen supplies required in Table 1 of 4.3.9 of this CAD.

6.7.3 Pressurised aeroplanes newly introduced into service on or after 1 July 1962 and intended to be operated at flight above 25 000 ft shall be equipped with a device to provide positive warning to the flight crew of any dangerous loss of pressurisation.

6.7.4 An aeroplane intended to be operated at flight altitudes above 25 000 ft, or which, if operated at flight altitudes below 25 000 ft, cannot descend safely within four minutes to 13 000 ft and for which the individual certificate of airworthiness is first

issued on or after 9 November 1998, shall be provided with automatically deployable oxygen equipment to satisfy the requirements in Table 1 of 4.3.9 of this CAD.

6.8 All aeroplanes in icing conditions

6.8.1 An operator shall not operate an aeroplane in expected or actual icing conditions unless it is certificated and equipped with suitable de-icing and/or anti-icing devices to operate in icing conditions.

6.8.2 An operator shall not operate an aeroplane in expected or actual icing conditions at night unless it is equipped with a means to illuminate or detect the formation of ice. Any illumination that is used must be of a type that will not cause glare or reflection that would handicap crew members in the performance of their duties.

6.9 All aeroplanes operated in accordance with instrument flight rules

6.9.1 Aeroplanes operated under VFR at night or under IFR shall be equipped with the following equipment, available at the pilot's station, a means of measuring and displaying:

- a) Magnetic heading;
- b) Time in hours, minutes and seconds;
- c) Indicated airspeed;
- d) Vertical speed;
- e) Turn and slip, or in the case of aeroplanes equipped with a standby means of measuring and displaying attitude, slip;
- f) Attitude;
- g) Stabilised heading;
- h) Outside air temperature; and
- i) Mach number whenever speed limitations are expressed in terms of Mach number.
- j) Two means of measuring and displaying barometric altitude.
- k) A means of indicating when the supply of power to the required flight instruments is not adequate.
- l) A means for preventing malfunction of the airspeed indicating systems required in paragraph 6.9.1c) and paragraph 6.9.2 b) due to condensation or icing.
- m) A means of annunciating to the flight crew the failure of the means required in paragraph 6.9.1 l) for aeroplanes:

- 1) issued with an individual CofA on or after 1 April 1998; or
 - 2) issued with an individual CofA before 1 April 1998 with an maximum certificated take-off mass of more than 5 700 kg, and with a maximum approved passenger seating configuration of more than nine (9).
- n) Except for propeller-driven aeroplanes with a maximum certificated take-off mass of 5 700 kg or less, two independent static pressure systems.
- o) One static pressure system and one alternate source of static pressure for propeller-driven aeroplanes with a maximum certificated take-off mass of 5 700 kg or less.

6.9.2 Whenever two pilots are required for the operation, a separate means of displaying for the second pilot:

- a) Barometric altitude;
- b) Indicated airspeed;
- c) Vertical speed;
- d) Turn and slip;
- e) Attitude; and
- f) Stabilised heading.
- g) A standby means of measuring and displaying attitude capable of being used from either pilot's station for aeroplanes with a maximum certificated take-off mass of more than 5 700 kg or a maximum approved passenger seating configuration of more than nine (9) that:
 - 1) is powered continuously during normal operation and, after a total failure of the normal electrical generating system, is powered from a source independent from the normal electrical generating system;
 - 2) provides reliable operation for a minimum of 30 minutes after total failure of the normal electrical generating system, taking into account other loads on the emergency power supply and operational procedures;
 - 3) operates independently of any other means of measuring and displaying attitude;
 - 4) is operative automatically after total failure of the normal electrical generating system;
 - 5) is appropriately illuminated during all phases of operation, except for aeroplanes with a maximum certificated take-off mass of 5 700 kg or less, already registered by 1 April 1995 and equipped with a standby attitude indicator in the left-hand instrument panel;
 - 6) is clearly evident to the flight crew when the standby attitude indicator is being operated by emergency power; and
 - 7) where the standby attitude indicator has its own dedicated power supply, has an associated indication, either on the instrument or on the instrument panel, when this supply is in use.

h) A chart holder in an easily readable position that can be illuminated for night operations.

6.9.3 Duplicate instruments should include separate displays for each pilot and separate selectors or other associated equipment where appropriate.

6.9.4 Individual equipment requirements may be met by combinations of instruments, by integrated flight systems or by a combination of parameters on electronic displays, provided that the information so available to each required pilot is so arranged as to permit the pilot to see their indications readily from his or her station, with the minimum practicable deviation from the position and line of vision normally assumed when looking forward along the flight path .

6.9.5 The means of measuring and indicating turn and slip, aeroplane attitude and stabilised aeroplane heading may be met by combinations of instruments or by integrated flight director systems, provided that the safeguards against total failure, inherent in the three separate instruments, are retained.

6.10 All aeroplanes when operated at night

6.10.1 All aeroplanes when operated at night shall be equipped with:

- a) An operator shall equip its aeroplane when operated at night with all equipment specified in 6.9;
- b) An operator shall ensure that its aeroplane is equipped with lights to be displayed as detailed in CAD 2;
- c) Two landing lights;
- d) illumination for all instruments and equipment that are essential for the safe operation of the aeroplane that are used by the flight crew;
- e) lights in all passenger compartments; and
- f) an independent portable light for each crew member station.

6.11 Airborne weather detecting equipment

6.11.1 The following shall be equipped with airborne weather detecting equipment when operated at night or in IMC in areas where thunderstorms or other potentially hazardous weather conditions, regarded as detectable with airborne weather detecting equipment, may be expected to exist along the route:

- a) pressurised aeroplanes;
- b) non-pressurised aeroplanes with a maximum certificated take-off mass of more than 5700 kg; and
- c) non-pressurised aeroplanes with a maximum approved passenger seating configuration of more than nine (9).

6.12 All aeroplanes operated above 15 000 m (49 000 ft) — radiation indicator

6.12.1 All aeroplanes intended to be operated above 15 000 m (49 000 ft) shall carry equipment to measure and indicate continuously the dose rate of total cosmic radiation being received (i.e. the total of ionising and neutron radiation of galactic and solar origin) and the cumulative dose on each flight. The display unit of the equipment shall be readily visible to a flight crew member.

6.13 All aeroplanes complying with the noise certification standards in Annex 16, Volume I

6.13.1 An operator shall ensure that the original or a copy of the noise certification , including an English translation, where one has been provided by the State of Registry, is carried on each flight.

Note.— The certification may be contained in any document, carried on board, approved by the State of Registry.

6.14 Mach number indicator

6.14.1 An operator shall ensure that:

- a) its aeroplanes with compressibility limitations not otherwise indicated by the required airspeed indicators shall be equipped with a Mach number indicator at each pilot's station.
- b) a Mach number indicator is fitted whenever speed limitations are expressed in terms of Mach number.

6.15 Aeroplanes required to be equipped with Ground Proximity Warning Systems (GPWS)

6.15.1 All turbine-engined aeroplanes of a maximum certificated take-off mass in excess of 5 700 kg or authorised to carry more than nine passengers shall be equipped with a ground proximity warning system which has a forward-looking terrain avoidance function.

6.15.2 The operator shall implement database management procedures that ensure the timely distribution and update of current terrain and obstacle data to the ground proximity warning system.

6.15.3 All turbine-engined aeroplanes of a maximum certificated take-off mass of 5 700 kg or less and authorised to carry more than five but not more than nine passengers should be equipped with a ground proximity warning system which provides the warnings of 6.15.6 a) and c), warning of unsafe terrain clearance and a forward looking terrain avoidance function.

6.15.4 All piston-engined aeroplanes of a maximum certificated take-off mass in excess of 5 700 kg or authorised to carry more than nine passengers shall be equipped

with a ground proximity warning system which provides the warnings in 6.15.6 a) and c), warning of unsafe terrain clearance and a forward-looking terrain avoidance function.

- 6.15.5 A ground proximity warning system shall provide automatically a timely and distinctive warning to the flight crew when the aeroplane is in potentially hazardous proximity to the earth's surface.
- 6.15.6 A ground proximity warning system shall provide, unless otherwise specified herein, warnings of the following circumstances:
- a) excessive descent rate;
 - b) excessive terrain closure rate;
 - c) excessive altitude loss after take-off or go-around;
 - d) unsafe terrain clearance while not in landing configuration:
 - 1) gear not locked down;
 - 2) flaps not in a landing position; and
 - e) excessive descent below the instrument glide path.

6.16 Aeroplanes carrying passengers — cabin crew seats

- 6.16.1 An operator shall ensure that each cabin crew seat and observer's seat are fitted with a safety belt with shoulder harness for aeroplanes for which the individual certificate of airworthiness is first issued on or after 1 January 1981. However, this requirement does not preclude use of passenger seats by cabin crew members carried in excess of the required cabin crew complement.
- 6.16.1.1 The seats shall be forward or rearward facing within 15° of the longitudinal axis of the aeroplane.
- 6.16.2 For Aeroplanes for which the individual certificate of airworthiness was first issued before 1 January 1981, an operator should ensure that each cabin crew seat and observer's seat are fitted with a safety belt with shoulder harness (within 15 degrees of the longitudinal axis of the aeroplane).
- 6.16.3 Cabin crew seats provided in accordance with 6.16.1 and 6.16.2 shall be located near floor level and other emergency exits as required by the CAAM for emergency evacuation..

6.17 Emergency locator transmitter (ELT)

- 6.17.1 An operator shall ensure that its aeroplanes which are authorised to carry more than 19 passengers are equipped with at least:

- a) two ELTs, one of which shall be automatic, or one ELT and one aircraft localisation means meeting the requirement of Paragraph 6.18.1, in the case of aeroplanes first issued with an individual CoA after 1 July 2008.

or

- b) one automatic ELT or two ELTs of any type or one aircraft localisation means meeting the requirement of Paragraph 6.18.1, in the case of aeroplanes first issued with an individual CoA on or before 1 July 2008.

6.17.2 An operator shall ensure that all its aeroplanes authorised to carry 19 or less passengers shall be equipped with at least:

- a) one automatic ELT or one aircraft localisation means meeting the requirement of 6.18.1, in the case of aeroplanes first issued with an individual CoA after 1 July 2008.

or

- b) one ELT of any type or one aircraft localisation means meeting the requirement of Paragraph 6.18.1, in the case of aeroplanes first issued with an individual CoA on or before 1 July 2008.

6.17.3 An ELT of any type shall be capable of transmitting simultaneously on 121.5 MHz and 406 MHz.

6.17.4 ELT equipment carried to satisfy the requirements of 6.17.1 and 6.17.2, shall operate in accordance with the relevant provisions of CAD 10, Volume III.

6.17.5 Types Of ELT And General Technical Specifications

6.17.5.1 The ELT required by this provision shall be one of the following:

- a) Automatic fixed (ELT(AF)). An automatically activated ELT that is permanently attached to an aircraft and is designed to aid search and rescue (SAR) teams in locating the crash site.
- b) Automatic portable (ELT(AP)). An automatically activated ELT, that is rigidly attached to an aircraft before a crash, but is readily removable from the aircraft after a crash. It functions as an ELT during the crash sequence. If the ELT(AP) does not employ an integral antenna, the aircraft-mounted antenna may be disconnected and an auxiliary antenna (stored on the ELT case) attached to the ELT. The ELT can be tethered to a survivor or a life-raft. This type of ELT is intended to aid SAR teams in locating the crash site or survivor(s).
- c) Automatic deployable (ELT(AD)) an ELT that is rigidly attached to the aircraft before the crash and that is automatically ejected, deployed and activated by an impact, and, in some cases, also by hydrostatic sensors.

Manual deployment is also provided. This type of ELT should float in water and is intended to aid SAR teams in locating the crash site.

- d) Survival ELT (ELT(S)). An ELT that is removable from an aircraft, stowed so as to facilitate its ready use in an emergency, and manually activated by a survivor. An ELT(S) may be activated manually or automatically (e.g. by water activation). It should be designed either to be tethered to a life-raft or a survivor.

6.18 Location of an aeroplane in distress

6.18.1 All aeroplanes of a maximum certificated take-off mass of over 27 000 kg for which the individual certificate of airworthiness is first issued on or after 1 January 2023, shall autonomously transmit information from which a position can be determined by the operator at least once every minute, when in distress, in accordance with Appendix 9.

6.18.2 The operator shall make position information of a flight in distress available to the appropriate organisations, as established by the CAAM.

6.19 Aeroplanes required to be equipped with an Airborne Collision Avoidance System (ACAS II)

6.19.1 All turbine-engined aeroplanes of a maximum certificated take-off mass in excess of 5 700 kg or authorised to carry more than 19 passengers shall be equipped with an airborne collision avoidance system (ACAS II).

6.19.2 An airborne collision avoidance system shall operate in accordance with the relevant provisions of CAD 10, Volume IV.

6.19.3 Use of ACAS II

- a) ACAS II shall be used in Malaysia, in a mode that enables RA indications to be produced for the flight crew when undue proximity to another aircraft is detected, unless inhibition of RA indication mode (using TA indication only or equivalent) is called for by an abnormal procedure or due to performance limiting conditions.
- b) when an RA indication is produced by ACAS II:
 - 1) the pilot flying shall immediately conform to the indications of the RA indication, even if this conflicts with an air traffic control (ATC) instruction, unless doing so would jeopardise the safety of the aircraft;
 - 2) the flight crew, as soon as permitted by workload, shall notify the appropriate ATC unit of any RA which requires a deviation from the current ATC instruction or clearance;
 - 3) when the conflict is resolved, the aircraft shall:
 - i) be promptly returned to the terms of the acknowledged ATC instruction or clearance and ATC notified of the manoeuvre; or

- ii) comply with any amended ATC clearance or instruction issued

6.19.4 Operators shall establish ACAS II operational procedures and training programmes so that the flight crew is appropriately trained in the avoidance of collisions and competent in the use of ACAS II equipment.

6.20 Requirements for pressure-altitude reporting transponders / altitude alerting system

6.20.1 All aeroplanes shall be equipped with a pressure-altitude reporting transponder which operates in accordance with the relevant provisions of CAD 10, Volume IV.

6.20.2 All aeroplanes shall be equipped with a data source that provides pressure-altitude information with a resolution of 7.62 m (25 ft), or better.

6.20.3 The following aeroplanes shall be equipped with an altitude alerting system:

- a) turbine propeller powered aeroplanes with a maximum certificated take-off mass of more than 5700 kg or having a maximum approved passenger seating configuration of more than (9) nine; and
- b) aeroplanes powered by turbo-jet engines.

6.20.4 The altitude alerting system shall be capable of:

- a) alerting the flight crew when approaching a preselected altitude; and
- b) alerting the flight crew by at least an aural signal, when deviating from a preselected altitude.

6.21 Microphones / interphones / public address system

6.21.1 An operator shall ensure that each flight crew member required to be on flight deck duty shall wear the headset with boom microphone or equivalent required by 6.21.4 and/or 6.21.5 and use it as the primary device to listen and communicate to the voice communications with Air Traffic Services:

- a) on the ground:
 - 1) when receiving the ATC departure clearance via voice communication; and
 - 2) when engines are running.
- b) in flight below transition altitude or 15,000 feet, whichever is higher, and
- c) whenever deemed necessary by the pilot-in-command.

6.21.2 In the conditions of paragraph 6.21.1 above, the boom microphone or equivalent shall be in a position which permits its use for two-way radio communications.

6.21.3 An operator shall not operate an aeroplane on which a flight crew of more than one is required unless it is equipped with a flight crew interphone system,

including headsets and microphones, not of a handheld type, for use by all members of the flight crew.

6.21.4 An operator shall not operate an aeroplane with a maximum certificated take-off mass exceeding 15000 kg or having a maximum approved maximum approved passenger seating configuration of more than 19 unless it is equipped with a crew member interphone system.

6.21.5 The crew member interphone system required by this paragraph must:

- a) Operate independently of the public address system except for handsets, headsets, microphones, selector switches and signalling devices.
- b) Provide a means of two-way communication between the flight crew compartment and:
 - 1) Each passenger compartments.
 - 2) Each galley located other than on a passenger deck level; and
 - 3) Each remote crew compartment that is not on the passenger deck and is not easily accessible from a passenger compartment;
- c) Be readily accessible for use from each of the required flight crew stations in the flight crew compartment;
- d) Be readily accessible for use at required cabin crew member stations close to each separate or pair of floor level emergency exits.
- e) Have an alerting system incorporating aural or visual signals for use by flight crew members to alert the cabin crew and for use by cabin crew members to alert the flight crew.
- f) Have a means for the recipient of a call to determine whether it is a normal call or an emergency call (see Note); and
- g) Provide on the ground a means of two-way communication between ground personnel and flight crew members.

Note. – The means of determining whether or not an interphone call is a normal or an emergency call may be one or a combination of the following:

- a) *Lights of different colours.*
- b) *Codes defined by the operator (e.g. Different number of rings for normal and emergency calls).*
- c) *Any other indicating signal acceptable to the CAAM.*

6.21.6 Aeroplanes with a maximum approved passenger seating configuration of more than 19 shall be equipped with a public address system.

6.22 Turbo-jet aeroplanes — forward-looking wind shear warning system

- 6.22.1 An operator shall not operate all turbo-jet aeroplanes of a maximum certificated take-off mass in excess of 5700 kg or authorised to carry more than nine passengers unless equipped with a forward-looking wind shear warning system capable of:
- a) Providing the pilot with a timely aural and visual warning of wind shear ahead of the aircraft, and the information required to permit the pilot to safely commence and continue a missed approach or go-around or to execute an escape manoeuvre if necessary.
 - b) Providing an indication to the pilot when the limits specified for the certification of automatic landing equipment are being approached, when such equipment is in use.
- 6.23 All aeroplanes operated by a single pilot under the instrument flight rules (IFR) or at night**
- 6.23.1 All operations involving single pilot under the instrument flight rules (IFR) or at night shall not be permitted in accordance with Regulation 49 of the MCAR 2016.
- 6.24 Aeroplanes equipped with Automatic Landing Systems, a Head-up Display (HUD) or equivalent displays, Enhanced Vision Systems (EVS), Synthetic Vision Systems (SVS) and/or Combined Vision Systems (CVS)**
- 6.24.1 Where aeroplanes are equipped with automatic landing systems, a HUD or equivalent displays, EVS, SVS or CVS, or any combination of those systems into a hybrid system, the use of such systems for the safe operation of an aeroplane shall be approved by the CAAM.
- Note.— Information regarding a HUD or equivalent displays, including references to RTCA and EUROCAE documents, is contained in the Manual of All-Weather Operations (ICAO Doc 9365).*
- 6.24.2 When seeking approval for the operational use of automatic landing systems, a HUD or equivalent displays, EVS, SVS or CVS, the operator shall ensure that:
- a) the equipment meets the appropriate airworthiness certification requirements;
 - b) the operator has carried out a safety risk assessment of the operations supported by the automatic landing systems, a HUD or equivalent displays, EVS, SVS or CVS;
 - c) the operator has established and documented the procedures for the use of, and training requirements for, automatic landing systems, a HUD or equivalent displays, EVS, SVS or CVS.
- Note 1.— Guidance on safety risk assessments is contained in the Safety Management Manual (SMM) (ICAO Doc 9859).*

Note 2.— Guidance on operational approvals is contained in Attachment H of this CAD.

6.25 Electronic flight bag (EFB)

6.25.1 EFB equipment

6.25.1.1 Where portable EFBs are used on board an aeroplane, the operator shall ensure that they do not affect the performance of the aeroplane systems, equipment or the ability to operate the aeroplane.

6.25.2 EFB functions

6.25.2.1 Where EFBs are used on board an aeroplane the operator shall:

- a) assess the safety risk(s) associated with each EFB function;
- b) establish and document the procedures for the use of, and training requirements for, the device and each EFB function; and
- c) ensure that, in the event of an EFB failure, sufficient information is readily available to the flight crew for the flight to be conducted safely.

Note.— Guidance on safety risk assessments is contained in the Safety Management Manual (SMM) (ICAO Doc 9859).

6.25.2.2 Operators are required to seek a specific approval from the CAAM prior to the operational use of EFB functions.

6.25.2.3 An operator with a specific approval to use an EFB during its operations must not in any of its operations:

- a) use a new EFB or a new function in such equipment; or
- b) use an amended EFB or amended function in such equipment.

until the operator has obtained CAAM's approval for such variation to the specific approval

6.25.3 EFB specific approval

6.25.3.1 To obtain a CAAM approval for the use of EFBs, the operator shall ensure that:

- a) the EFB equipment and its associated installation hardware, including interaction with aeroplane systems if applicable, meet the appropriate airworthiness certification requirements;
- b) the safety risks assessment associated with the operations supported by the EFB function(s) has been carried out;
- c) requirements have been established for redundancy of the information (if appropriate) contained in and displayed by the EFB function(s);

- d) procedures for the management of the EFB function(s) including any database it may use have been established and documented; and
 - e) the procedures for the use of, and training requirements for, the EFB and the EFB function(s) have been established and documented.
- 6.25.3.2 If the CAAM is satisfied that the operator has fulfilled the requirements, the CAAM may issue an initial approval which include flight crew training, checking and currency requirements.
- 6.25.3.3 The initial approval shall be for a period of 6 months.
- 6.25.3.4 During the period of 6 months, the operator shall conduct an operational evaluation. This operational evaluation requires the operator to carry both the EFB system and paper copies before the final approval, allowing the EFB to reduce or eliminate paper copies on the flight deck
- 6.25.3.5 The operator shall submit a final report to the CAAM after the 6 month evaluation period of the EFB system.
- 6.25.3.6 If the CAAM is satisfied that the operator has fulfilled the requirements, the CAAM may issue a final approval in the Operational Specifications or Letter of Approval.
- 6.25.4 Continuing Airworthiness and training for maintenance personnel
- 6.25.4.1 The operator shall establish a documented maintenance procedure to ensure the EFB is well maintained.
- 6.25.4.2 For the rechargeable lithium-type batteries, the operator shall ensure that the maintenance procedures meet the Original Equipment Manufacturer (OEM)'s recommendations.
- 6.25.4.3 The operator shall review and update the following documents to reflect the operation of EFB as applicable:
- a) Maintenance program
 - b) Minimum Equipment List (MEL); and
 - c) Aircraft Flight Manual Supplement (AFMS).
- 6.25.4.4 The operator shall develop a training program for all the maintenance personnel who are involved with the EFB operations. The training program shall consist of initial and recurrent training and include at least the overview of the EFB specificities, maintenance procedures and safety management. The operator shall regularly review the training program to ensure that the training program is relevant with the current technologies and effectively implemented.

Note – Guidance on EFB equipment, functions and operational approval is contained in the CAGM 6008(V) – EFB and ICAO Doc 10020.

6.26 Crew protective breathing equipment

- 6.26.1 All pressurised aeroplanes and those unpressurised aeroplanes with a maximum certificated take-off mass of more than 5700 kg or having a maximum approved passenger seating configuration of more than 19 seats shall be equipped with protective breathing equipment (PBE) to protect eyes, nose and mouth and to provide for a period of at least 15 minutes:
- a) oxygen for each flight crew member on duty in the flight crew compartment;
 - b) breathing gas for each required cabin crew member, adjacent to his assigned station; and
 - c) breathing gas from a portable PBE for one member of the flight crew, adjacent to his assigned station, in the case of aeroplanes operated with a flight crew of more than one and no cabin crew member.
- 6.26.2 A PBE intended for flight crew use shall be installed in the flight crew compartment and be accessible for immediate use by each required flight crew member at his assigned station.
- 6.26.3 A PBE intended for cabin crew use shall be installed adjacent to each required cabin crew member station.
- 6.26.4 Aeroplanes shall be equipped with an additional portable PBE installed adjacent to the hand fire extinguisher referred to in 6.2.4.9 c) and d), or adjacent to the entrance of the cargo compartment, in case the hand fire extinguisher is installed in a cargo compartment.
- 6.26.5 A PBE while in use shall not prevent the use of the means of communication referred to in 6.21.3, 6.21.4, 6.2.5, and 7.1.1.

7 Aeroplane Communication, Navigation And Surveillance Equipment

7.1 Communication equipment

7.1.1 An aeroplane shall be provided with radio communication equipment capable of:

- a) conducting two-way communication for aerodrome control purposes;
- b) receiving meteorological information at any time during flight; and
- c) conducting two-way communication at any time during flight with at least one aeronautical station and with such other aeronautical stations and on such frequencies as may be prescribed by the CAAM.

Note: The requirements of 7.1.1 are considered fulfilled if the ability to conduct the communications specified therein is established during radio propagation conditions which are normal for the route.

7.1.2 The radio communication equipment required in accordance with 7.1.1 shall provide for communications on the aeronautical emergency frequency 121.5 MHz.

7.1.3 For operations where communication equipment is required to meet an RCP specification for performance-based communication (PBC) , an aeroplane shall, in addition to the requirements specified in 7.1.1:

- a) be provided with communication equipment which will enable it to operate in accordance with the prescribed Required Communications Performance RCP type(s);
- b) have information relevant to the aeroplane RCP specification capabilities listed in the flight manual or other aeroplane documentation approved by the State of Design or State of Registry;
- c) have information relevant to the aeroplane navigation specification capabilities included in the MEL; and
- d) be authorised by the CAAM for operations in such airspace.

Note.— Information on the performance-based communication and surveillance (PBCS) concept and guidance material on its implementation are contained in the Performance-based Communication and Surveillance (PBCS) Manual (ICAO Doc 9869) and CAGM 6008 (VI) - NAT HLA, PBCS, CPDLC & ADS.

7.1.4 The operator shall, for operations where an RCP specification for PBC has been prescribed, ensure that they establish and document the following:

- a) normal and abnormal procedures, including contingency procedures;
- b) flight crew qualification and proficiency requirements, in accordance with appropriate RCP specifications;

- c) a training programme for relevant personnel consistent with the intended operations; and
- d) appropriate maintenance procedures to ensure continued airworthiness, in accordance with appropriate RCP specifications.
- e) the equipment in accordance with the required communication performance;
- f) identify the specific aircraft to be used for the operations for which approval is sought;
- g) demonstrate that any aeroplane so identified is appropriately equipped to perform in accordance with the required communication performance specified by the appropriate air traffic service authority for the airspace or along the route for which the approval is sought;
- h) specify the airspace or routes for which approval is sought.

7.1.5 With respect to those aeroplanes mentioned in 7.1.3, the CAAM will:

- a) receive reports of observed communication performance issued by monitoring programmes established in accordance with CAD 11, Chapter 3; and
- b) take immediate corrective action for individual aircraft, aircraft types or operators, identified in such reports as not complying with the RCP specification(s).

7.1.6 An operator seeking a specific approval to use a data link system for communications, navigation or surveillance during its operations shall:

- a) identify the aircraft for which the specific approval is sought;
- b) specify the equipment to be carried so identified such that the aircraft is in compliance with standards and the requirements specified by the CAAM;
- c) provide details of:
 - 1) a training programme for every person to be involved in such operations as a flight crew member or a member of the operations personnel; and
 - 2) procedures for ensuring that these requirements and the conditions of this specific approval are met.

7.2 Navigation equipment

7.2.1 An aeroplane shall be provided with navigation equipment which will enable it to proceed:

- a) in accordance with its operational flight plan; and
- b) in accordance with the requirements of air traffic services;

except when, if not so precluded by the appropriate authority, navigation for flights under the visual flight rules is accomplished by visual reference to landmarks.

7.2.2

An operator seeking a specific approval to conduct PBN operations shall:

- a) identify the particular aircraft to be used for the PBN operations;
- b) specify the equipment to be carried on board the identified aircraft such that the aircraft is equipped to perform in accordance with relevant PBN specifications;
- c) specify the composition and experience requirement of the flight crew for a flight involving the PBN operations;
- d) have information relevant to the aeroplane navigation specification capabilities listed in the flight manual or other aeroplane documentation approved by the State of the Design or State of Registry;
- e) have information relevant to the aeroplane navigation specification capabilities included in the MEL; and
- f) provide details of:
 - 1) procedures for normal and contingency situations;
 - 2) incident reporting procedures;
 - 3) training programme for every person to be involved in the PBN operations as a flight crew member or a member of the operations personnel;
 - 4) to have a continuous monitoring programme to ensure the required level of navigation performance is maintained;
 - 5) appropriate maintenance procedures to ensure continued airworthiness in accordance with the appropriate navigation specifications.
- g) For the purpose of granting an operational approval for an aircraft to be operated in the PBN airspace, airworthiness recommendation is required. Applicant shall submit an Engineering Report which contains:
 - 1) particulars of aircraft to be operated;
 - 2) navigation equipment which will enable it to operate in accordance with the intended navigation specifications;
 - 3) information relevant to the aircraft eligibility and evidence of compliance with the navigation specifications for a particular PBN application provided there is clear statement in
 - i) the Type Certificate (TC); or
 - ii) the Supplemental Type Certificate (STC); or
 - iii) the compliance statement from the manufacturer that has been approved by the State of Design and accepted by the CAAM.
 - 4) the aircraft configuration list detailing the installation of the pertinent hardware and software components related to the PBN operation;

- 5) the control of navigation database procedures which will define the data validation procedures for navigation databases and installation of new databases into aircraft so that they remain current with the Aeronautical Information Regulation and Control (AIRAC) cycle;
- 6) the training programme for personnel involved in the PBN operations;
- 7) continued airworthiness procedures for assessing and incorporating instructions for continued airworthiness and maintenance or inspection information concerning system modification, software revisions, etc;
- 8) the aircraft's Aircraft Maintenance Programme (AMP), Reliability Programme and Minimum Equipment List (MEL) had been incorporated with the relevant PBN elements and systems;
- 9) the aircraft current and updated Electrical Load Analysis; and
- 10) the completed checklist for PBN Airworthiness Assessment Review - Performance Based Navigation (PBN).

- h) The applicant shall ensure that aircraft system is properly maintained to meet the appropriate navigation specifications.
- i) No applicants shall conduct any modifications, or repairs on the aircraft which may impact the PBN related capability and systems.
- j) In the case of modifications, or repairs that give impact to the PBN related capability and systems, the applicant shall inform CAAM on the changes made and provide information to ensure that the PBN related capability and systems is in compliance to this CAD.

7.2.3 An operator with a specific approval to conduct a PBN operations must ensure that the aircraft used to conduct the PBN operation have flight crew members that:

- a) are of the composition and experience required for such operations; and
- b) have completed the training programme established in 7.2.2 f) 3) for every flight crew member involved in such operations.

7.2.4 An operator with a specific approval to conduct PBN operations must ensure that, when its aircraft is used to conduct a PBN operations, the flight crew comprises of at least 2 pilots.

Note 1. – Information on performance-based navigation, and guidance concerning the implementation and operational approval process, are contained in CAGM 6008 (II) Performance-based Navigation (PBN) Manual and ICAO Doc 9613.

Note 2.— Guidance on safety risks and mitigations for PBN operations, in accordance with Annex 19, are contained in the Performance-based Navigation (PBN) Operational Approval Manual (ICAO Doc 9997).

7.2.5 For flights in defined portions of the North Atlantic (NAT) airspace where, based on Regional Air Navigation Agreement, High Level Airspace Approval (HLA) is

required (minimum navigation performance specifications (MNPS)), an aeroplane shall be provided with navigation equipment which:

- a) continuously provides indications to the flight crew of adherence to or departure from track to the required degree of accuracy at any point along that track; and
- b) has been authorised by the CAAM for the NAT HLA (MNPS) operations concerned.

Note. – The prescribed minimum navigation performance specifications and the procedures governing their application are published in the Regional Supplementary Procedures ICAO Doc 7030 and CAGM 6008 (VI) NAT HLA, PBCS, CPDLC & ADS.

7.2.6 For flights in defined portions of airspace where, based on Regional Air Navigation Agreement, a reduced vertical separation minimum (RVSM) of 1 000 feet (300 m) is applied between FL 290 and FL 410 inclusive, an aeroplane:

- a) shall be provided with equipment which is capable of:
 - 1) indicating to the flight crew the flight level being flown;
 - 2) automatically maintaining a selected flight level;
 - 3) providing an alert to the flight crew when a deviation occurs from the selected flight level. The threshold for the alert shall not exceed ± 300 feet (90m); and
 - 4) automatically reporting pressure-altitude;
- b) shall be authorised by the CAAM for operation in the airspace concerned; and
- c) shall demonstrate a vertical navigation performance in accordance with Appendix 4.

7.2.7 Prior to granting the RVSM approval required in accordance with paragraph 7.2.6 b), the CAAM shall be satisfied that:

- a) the vertical navigation performance capability of the aeroplane satisfies the Altimetry System requirement for operations in RVSM airspace;
- b) the operator has instituted appropriate procedures in respect of continued airworthiness (maintenance and repair) practices and programmes; and
- c) the operator has instituted appropriate flight crew procedures for operations in RVSM airspace.
- d) the operator shall establish a RVSM maintenance and inspection programme for the altimeter system and altitude reporting equipment in accordance with CAGM 6008 (I)
- e) no modifications, or repairs on the aircraft which may impact the altitude keeping ability and the RVSM system are made. In the case of modifications

or repairs which give impact to the altitude keeping ability or the RVSM system, the operator shall meet the associated standards of this CAD.

Note. – An RVSM approval is valid globally on the understanding that any operating procedures specific to a given region will be stated in the operations manual or appropriate crew guidance.

7.2.8 With respect to those aeroplanes mentioned in paragraph 7.2.6, the CAAM, in consultation with the State of Registry if appropriate will:

- a) receive reports of height-keeping performance issued by the monitoring agencies; and
- b) take immediate corrective action for individual aircraft, or aircraft type groups, identified in such reports as not complying with the height-keeping requirements for operation in airspace where RVSM is applied.

7.2.9 The operator that has been issued an RVSM approval shall establish a requirement which ensures that a minimum of two aeroplanes of each aircraft type grouping of the operator have their height-keeping performance monitored, at least once every two years or within intervals of 1 000 flight hours per aeroplane, whichever period is longer. If an operator aircraft type grouping consists of a single aeroplane, monitoring of that aeroplane shall be accomplished every two years or within intervals of 1 000 flight hours.

Note. – Monitoring data from any regional monitoring programme be used to satisfy the requirement.

7.2.10 Monitoring Agency for Asia Region (MAAR), established by Aeronautical Radio of Thailand, Ltd. (AEROTHAI) under the approval of the Asia/Pacific Air Navigation Planning and Implementation Regional Group (APANPIRG) to assume the duties and responsibilities of the Regional Monitoring Agency (RMA) for the Asia Region.

7.2.10.1 The principal role of the MAAR is to assist the International Civil Aviation Organisation (ICAO) in the continuation of the safety assessment program for the implementation of Reduced Vertical Separation Minimum (RVSM) and other monitoring requirements as determined by the APANPIRG.

7.2.10.2 Malaysia registered aircraft with an RVSM approval are registered with MAAR. MAAR maintains a central registry of state RVSM approvals of operators and aircraft using the pacific region airspace where RVSM is applied. MAAR is responsible for determining whether an operator's fleet has demonstrated acceptable height keeping performance.

Note. – Guidance material relating to the approval for operation in RVSM airspace is contained in CAGM 6008 (I) and Manual on Implementation of 1 000 feet (300 m) Vertical Separation Minimum between FL 290 and FL 410 Inclusive ICAO Doc 9574.

- 7.2.11 The aeroplane shall be sufficiently provided with navigation equipment to ensure that, in the event of the failure of one item of equipment at any stage of the flight, the remaining equipment will enable the aeroplane to navigate in accordance with paragraph 7.2.1 and, where applicable, paragraph 7.2.2, 7.2.5 and 7.2.6.
- 7.2.12 On flights in which it is intended to land in instrument meteorological conditions, an aeroplane shall be provided with radio equipment capable of receiving signals providing guidance to a point from which a visual landing can be affected. This equipment shall be capable of providing such guidance for each aerodrome at which it is intended to land in instrument meteorological conditions and for any designated alternate aerodromes.
- 7.2.13 An operator with a specific approval to conduct operations as specified in paragraph 7.2.2, 7.2.5, and 7.2.6 shall have a programme to monitor the aeroplane to be used for specified navigation performance operations to ensure the required level of navigation performance is maintained.

7.3 Surveillance equipment

- 7.3.1 An aeroplane shall be provided with surveillance equipment which will enable it to operate in accordance with the requirements of air traffic services.
- 7.3.2 For operations where surveillance equipment is required to meet an RSP specification for performance-based surveillance (PBS), an aeroplane shall, in addition to the requirements specified in 7.3.1:
- a) be provided with surveillance equipment which will enable it to operate in accordance with the prescribed RSP specification(s);
 - b) have information relevant to the aeroplane RSP specification capabilities listed in the flight manual or other aeroplane documentation approved by the State of Design or State of Registry;
 - c) have information relevant to the aeroplane RSP specification capabilities included in the MEL; and
 - d) be authorised by the CAAM for operations in such airspace.

Note 1.— Information on surveillance equipment is contained in the Aeronautical Surveillance Manual (ICAO Doc 9924).

Note 2.— Information on RSP specifications for performance-based surveillance is contained in the Performance-based Communication and Surveillance (PBCS) Manual (ICAO Doc 9869) and CAGM 6008 (VI) NAT HLA, PBCS, CPDLC & ADS..

- 7.3.3 The operator shall, for operations where an RSP specification for PBS has been prescribed, ensure that they establish and document the following:
- a) normal and abnormal procedures, including contingency procedures;

- b) flight crew qualification and proficiency requirements, in accordance with appropriate RSP specifications;
- c) a training programme for relevant personnel consistent with the intended operations; and
- d) appropriate maintenance procedures to ensure continued airworthiness, in accordance with appropriate RSP specifications;
- e) the equipment in accordance with the required surveillance performance;
- f) identify the specific aeroplane to be used for the operations for which approval is sought;
- g) demonstrate that any aeroplane so identified is appropriately equipped to perform in accordance with the required surveillance performance specified by the appropriate air traffic service authority for the airspace or along the route for which the approval is sought;
- h) specify the airspace or routes for which approval is sought;

7.3.4 With respect to those aeroplanes mentioned in 7.3.2, the CAAM will:

- a) receive reports of observed communication performance issued by monitoring programmes established in accordance with CAD 11, Chapter 3, 3.3.5.2; and
- b) take immediate corrective action for individual aircraft, aircraft types or operators, identified in such reports as not complying with the RSP specification(s).

7.4 Installation

7.4.1 The equipment installation shall be such that the failure of any single unit required for communication, navigation or surveillance purposes or any combination thereof will not result in the failure of another unit required for communication, navigation or surveillance purposes.

7.5 Electronic Navigation Data Management

7.5.1 Electronic navigation data management.

7.5.1.1 The operator shall only use electronic navigation data products that support a navigation application meeting standard of integrity that are adequate for the intended use of the data.

7.5.1.2 When the electronic navigation data products support a navigation application, needed for an operation that requires an approval, the operator shall demonstrate to the CAAM that the process applied and the delivered products meet standards of integrity that are adequate for the intended use of the data.

- 7.5.1.3 The operator shall continuously monitor the integrity of both the process and the products, either directly or by monitoring the compliance of third-party providers.

Note.— Guidance relating to the processes that data suppliers may follow is contained in RTCA DO-200A/EUROCAE ED-76 and RTCA DO-201A/EUROCAE ED-77.

- 7.5.2 The operator shall ensure the timely distribution and insertion of current and unaltered electronic navigation data to all its aeroplanes that require it.

7.6 Performance Based Communication and Surveillance (PBCS)

- 7.6.1 An operator seeking a specific approval to conduct any operations in an airspace or along a route where the appropriate air traffic service authority has specified a combination of the requirements of 7.1.3, 7.1.4, 7.1.6 and 7.3, for any aircraft operating in that airspace or along that route (called in this CAD a PBCS operation), must comply with the requirements of 7.1.3, 7.1.4, 7.1.6 and 7.3.

Note. – Refer CAGM 6008 (VI) for additional guidance on PBCS.



INTENTIONALLY LEFT BLANK

8 Aeroplane Continuing Airworthiness

8.1 Operator's Continuing Airworthiness responsibilities.

8.1.1 Operators shall ensure that:

- a) each aeroplane they operate is maintained in an airworthy condition;
- b) the operational and emergency equipment necessary for an intended flight is serviceable; and
- c) the certificate of airworthiness of each aeroplane they operate remains valid.

8.1.2 the operator shall not operate an aeroplane unless maintenance on the aeroplane, including any associated engine, propeller and part, is carried out:

- a) by an organisation in compliance with CAD 8601; or
- b) for foreign registered aircraft, under lease arrangement in accordance with CAD 6014 and there is a maintenance release in relation to the maintenance carried out.

8.1.3 *RESERVED*

8.1.4 The operator shall employ a person or group of persons to ensure that all maintenance is carried out in accordance with the continuing airworthiness management exposition.

8.1.5 The operator shall ensure that the maintenance of its aeroplanes is performed in accordance with the maintenance programme.

Note. – Refer CAD 6801 Continuing Airworthiness of Aircraft (CAAM Part M).

8.2 Continuing airworthiness management exposition

8.2.1 The operator shall provide, for the use and guidance of maintenance and operational personnel concerned, a continuing airworthiness management exposition, acceptable to CAAM, in accordance with the requirements of 11.2. The design of the exposition shall observe Human Factors principles.

8.2.2 The operator shall ensure that the continuing airworthiness management exposition is amended as necessary to keep the information contained therein up to date.

8.2.3 Copies of all amendments to the continuing airworthiness management exposition shall be furnished promptly to all organisations or persons to whom the exposition has been issued.

8.2.4 The operator shall provide the CAAM and the State of Registry with a copy of the continuing airworthiness management exposition, together with all

amendments and/or revisions to it and shall incorporate in it such mandatory material as the CAAM or the State of Registry may require.

Note. – Refer CAD 6802 Continuing Airworthiness Management Organisation (CAAM Part M Subpart G)

8.3 Maintenance programme.

8.3.1 The operator shall provide, for the use and guidance of maintenance and operational personnel concerned, a maintenance programme, approved by the State of Registry, containing the information required by 11.3. The design and application of the operator's maintenance programme shall observe Human Factors principles.

8.3.2 Copies of all amendments to the maintenance programme shall be furnished promptly to all organisations or persons to whom the maintenance programme has been issued.

8.4 Continuing airworthiness records.

8.4.1 The operator shall ensure that the following records are kept for the periods mentioned in 8.4.2:

- a) the total time in service (hours, calendar time and cycles, as appropriate) of the aeroplane and all life-limited components;
- b) the current status of compliance with all mandatory continuing airworthiness information;
- c) appropriate details of modifications and repairs;
- d) the time in service (hours, calendar time and cycles, as appropriate) since the last overhaul of the aeroplane or its components subject to a mandatory overhaul life;
- e) the current status of the aeroplane's compliance with the maintenance programme; and
- f) the detailed maintenance records to show that all requirements for the signing of a maintenance release have been met.

8.4.2 The records in 8.4.1 a) to f) shall be kept for a minimum period of 12 months after the unit to which they refer has been permanently withdrawn from service.

8.4.3 In the event of a temporary change of operator, the records shall be made available to the new operator. In the event of any permanent change of operator, the records shall be transferred to the new operator.

8.4.4 Records kept and transferred in accordance with 8.4 shall be maintained in a form and format that ensures readability, security and integrity of the records at all times.

8.5 Continuing airworthiness information

- 8.5.1 The operator of an aeroplane over 5 700 kg maximum certificated take-off mass shall monitor and assess maintenance and operational experience with respect to continuing airworthiness and provide the information as prescribed by CAAM and report through the system as prescribed by the CAAM.
- 8.5.2 The operator of an aeroplane over 5 700 kg maximum certificated take-off mass shall obtain and assess continuing airworthiness information and recommendations available from the organisation responsible for the type design and shall implement resulting actions considered necessary in accordance with a procedure acceptable to CAAM.

8.6 Modifications and repairs

- 8.6.1 All modifications and repairs shall comply with airworthiness requirements acceptable to the State of Registry. Procedures shall be established to ensure that the substantiating data supporting compliance with the airworthiness requirements are retained.

8.7 Approved maintenance organisation

- 8.7.1 An approved maintenance organisation shall comply with CAD 8, Part II, Chapter 6 – Maintenance organisation approval.
- 8.7.2 For foreign registered aircraft, the approved maintenance organisation shall comply with Annex 8 Part II, Chapter 6.

8.8 Maintenance release

- 8.8.1 When maintenance is carried out by an approved maintenance organisation, the maintenance release shall be issued by the approved maintenance organisation in accordance with the provisions of CAD 8, Part II, Chapter 6, 6.8.
- 8.8.2 For foreign registered aircraft, the maintenance release shall be issued by the approved maintenance organisation in accordance with Annex 8 Part II, Chapter 6.



INTENTIONALLY LEFT BLANK

9 Aeroplane Flight Crew

9.1 Composition of the flight crew

9.1.1 Composition of Flight Crew - General.

9.1.1.1 The operator shall ensure that the composition of flight crew meets the following requirements:

- a) The composition of the flight crew and the number of flight crew members at designated crew stations shall be not less than the minimum specified in the flight manual or operating limitations prescribed for the aircraft.
- b) The flight crew shall include additional flight crew members when required by the type of operation and shall not be reduced below the number specified in the operations manual.
- c) All flight crew members shall hold a licence and ratings issued or accepted by the CAAM and appropriate to the duties assigned to them.
- d) The flight crew member may be relieved in flight of his duties at the controls by another suitably qualified flight crew member.

9.1.2 Composition of flight crew – Specific Requirements.

9.1.2.1 The operator shall ensure that there shall not be more than one inexperienced flight crew member in any flight crew.

9.1.2.2 The pilot-in-command may delegate the conduct of the flight to another pilot suitably qualified in accordance with CAD 1 provided that the following requirements are complied with:

- a) The operator shall only designate a flight crew member to act as pilot-in-command if he has:
 - 1) the minimum level of experience specified in the operations manual.
 - 2) adequate knowledge of the route or area to be flown and of the aerodromes, including alternate aerodromes, facilities and procedures to be used;
- b) The pilot-in-command or the pilot, to whom the conduct of the flight may be delegated, shall have had initial familiarisation training of the route or area to be flown and of the aerodromes, facilities and procedures to be used. This route/area and aerodrome knowledge shall be maintained by operating at least once on the route or area or to the aerodrome within a 12 month period.

9.1.2.3 Specific requirements for aeroplane operations under instrument flight rules (IFR) or at night.

- a) The minimum flight crew shall be two pilots for all turbo-propeller aeroplanes with a maximum approved passenger seating configuration of more than nine and all turbojet aeroplanes.

9.1.3 Crewing of inexperienced flight crew members

9.1.3.1 The operator shall establish procedures in the OM taking into account the following elements:

- a) The operator shall consider that a flight crew member is inexperienced, following completion of a type rating or command course, and the associated line flying under supervision, until he has achieved on the type either:
 - 1) 100 flight hours and flown 10 sectors within a consolidation period of 120 consecutive days; or
 - 2) 150 flight hours and flown 20 sectors (no time limit).
- b) A lesser number of flight hours or sectors, subject to any other conditions that the CAAM may impose, may be acceptable to the CAAM when one of the following applies:
 - 1) a new operator is commencing operations.
 - 2) an operator introduces a new aeroplane type.
 - 3) flight crew members have previously completed a type conversion course with the same operator.
 - 4) credits are defined in the operational suitability data established by the CAAM; or
 - 5) the aeroplane has a maximum certificated take-off mass of less than 10 tonnes or a maximum maximum approved passenger seating configuration of less than 20.

9.1.4 Minimum flight crew for operations under IFR or at night. For operations under IFR or at night, an operator shall ensure that:

9.1.4.1 For all turbo-propeller aeroplanes with a maximum approved passenger seating configuration of more than 9 and for all turbojet aeroplanes, the minimum flight crew is 2 pilots; or

9.1.4.2 Aeroplanes other than those covered by 9.1.4.1 are operated by a single pilot provided that the requirements of 9.1.1 are satisfied. If these requirements are not satisfied, the minimum flight crew is 2 pilots.

9.1.5 Radio operator



9.1.5.1 An operator shall ensure that the flight crew shall include at least one member who holds a valid licence, issued or rendered valid by the CAAM, authorising operation of the type of radio transmitting equipment to be used.

9.1.6 Flight engineer

9.1.6.1 When a separate flight engineer's station is incorporated in the design of an aeroplane, the flight crew shall include at least one flight engineer especially assigned to that station, unless the duties associated with that station can be satisfactorily performed by another flight crew member, holding a flight engineer licence, without interference with regular duties

9.1.7 Flight navigator
-RESERVED-

9.2 Flight crew member emergency duties

9.2.1 The operator shall, for each type of aeroplane, assign to all flight crew members the necessary functions they are to perform in an emergency or in a situation requiring emergency evacuation. Annual training in accomplishing these functions shall be contained in the operator's training programme and shall include instruction in the use of all emergency and life-saving equipment required to be carried, and drills in the emergency evacuation of the aeroplane.

9.2.1.1 An operator shall ensure the following requirements are met on emergency procedures:

- a) Instructions for preparation for emergency evacuation including crew co-ordination and emergency station assignment.
- b) Emergency evacuation procedures. A description of the duties of all members of the crew for the rapid evacuation of an aeroplane and the handling of the passengers in the event of a forced landing, ditching or other emergency.

9.2.1.2 Emergency and Safety Equipment training and checking (SEP). An operator shall ensure that each flight crew member undergoes training and checking on the location and use of all emergency and safety equipment carried. An SEP check shall be valid to the end of the month which it is done, 12 calendar months later. If the SEP renewal is carried out within the final 3 months of validity, the period of validity shall extend from the date of issue until 12 calendar months after the expiry date of the previous SEP check.

9.3 Flight crew member training programmes

9.3.1 General

- 9.3.1.1 An Operator shall establish and maintain a ground and flight training programme, approved by the CAAM which ensures that all flight crew members are adequately trained to perform their assigned duties.
- 9.3.1.2 The training programme shall:
- a) include ground and flight training facilities and properly qualified instructors;
 - b) consist of ground and flight training in the type(s) of aeroplane on which the flight crew members serve;
 - c) include proper flight crew coordination and training in all types of emergency and abnormal situations or procedures caused by power plant, airframe or systems malfunctions, fire or other abnormalities;
 - d) include training in knowledge and skills related to visual and instrument flight procedures for the intended area of operation, human performance including threat and error management and in the transport of dangerous goods;
 - e) ensure that all flight crew members know the functions for which they are responsible and the relation of these functions to the functions of other crew members, particularly in regard to abnormal or emergency procedures;
 - f) include upset prevention and recovery training;
 - g) training be given on a recurrent basis and shall include an assessment of competence.
 - h) Safety equipment training and checking as described in 9.2.1.2.
- 9.3.2 The requirement for recurrent flight training as stated in 9.3.6 in a particular type of aeroplane shall be considered fulfilled by:
- a) the use, to the extent deemed feasible by the CAAM, of flight simulation training devices approved by the CAAM for that purpose; or
 - b) the completion within the appropriate period of the proficiency check required by paragraph 9.4.4 in that type of aeroplane.
- 9.3.2.1 The scope of the recurrent training required by 9.2 and 9.3 may be varied and need not be as extensive as the initial training given in a particular type of aeroplane.
- 9.3.3 Initial Operator's Crew Resource Management (CRM) training.
- 9.3.3.1 The flight crew member shall have completed an initial CRM training course before commencing unsupervised line flying.

- 9.3.3.2 If the flight crew has not previously received theoretical training in human factors to the ATPL level, he shall complete, before or combined with the initial CRM training, a theoretical course provided by the operator and based on the human performance limitations syllabus for the ATPL.
- 9.3.3.3 Initial CRM training shall be conducted by at least one CRM instructor acceptable to the CAAM who may be assisted by experts in order to address specific areas, and conducted in accordance with a detailed course syllabus included in the Operations Manual.
- 9.3.3.4 The CRM training shall be valid to the end of the month which it is done, 12 calendar months later
- 9.3.4 Conversion training and checking
- 9.3.4.1 An operator shall ensure that:
- a) A flight crew member completes a course which satisfies the requirements applicable to the issue of Flight Crew Licences when changing from one type of aeroplane to another type or class for which a new type or class rating is required.
 - b) A flight crew member completes an operator's conversion course before commencing unsupervised line flying:
 - 1) When changing to an aeroplane for which a new type or class rating is required; or
 - 2) When changing operator.
 - c) Conversion training is conducted by suitably qualified personnel in accordance with a detailed course syllabus included in the Operations Manual. The operator shall ensure that the personnel integrating elements of CRM into conversion training are suitably qualified.
 - d) The amount of training required by the operator's conversion course is determined after due note has been taken of the flight crew member's previous training as recorded in his training records.
 - e) The minimum standards of qualification and experience required of flight crew members before undertaking conversion training are specified in the Operations Manual.
 - f) Each flight crew member undergoes the checks required by 9.4.4.1 and the training and checks required by 9.2.1 before commencing line flying under supervision.
 - g) Once an operator's conversion course has been commenced, a flight crew member does not undertake flying duties on another type or class until the course is completed or terminated; and

h) Elements of CRM training are integrated into the conversion course.

9.3.4.2 In the case of changing aeroplane type or class, the check required by 9.4.4.1 may be combined with the type or class rating skill test under the requirements applicable to the issue of Flight Crew Licences.

9.3.4.3 The operator's conversion course and the Type or Class Rating course required for the issue of Flight Crew Licences may be combined.

9.3.4.4 Flight crew that have been issued a type rating based on a zero flight-time training (ZFTT) course shall:

a) Have completed six take-offs and landings in a FSTD not later than 21 days after completion of the skill test under the supervision of a designated examiner occupying the other pilot seat. If these take-offs and landings have not been performed within 21 days, the operator shall provide appropriate training acceptable to the CAAM.

b) Commence Line Flying Under Supervision not later than 21 days after completion of the skill test or appropriate training provided by the operator. If Line Flying Under Supervision has not been commenced within the 21 days, the operator shall provide appropriate training acceptable to the CAAM.

c) Conduct the first four take-offs and landings of the Line Flying Under Supervision in the aeroplane under the supervision of a designated examiner occupying the other pilot seat.

9.3.5 Differences training and Familiarisation training.

9.3.5.1 An operator shall ensure that a flight crew member completes:

a) Differences training which requires additional knowledge and training on an appropriate training device or the aeroplane. It shall be carried out:

- 1) When introducing a significant change of equipment and/or procedures on types or variants currently operated; and
- 2) When operating another variant of an aeroplane of the same type or another type of the same class currently operated; or

b) Familiarisation training which requires the acquisition of additional knowledge. It shall be carried out:

- 1) When operating another aeroplane of the same type; or
- 2) When introducing a significant change of equipment and/or procedures on types or variants currently operated.

9.3.5.2 The operator shall specify in the Operations Manual when such differences training or familiarisation training is required.

- 9.3.6 Recurrent training and checking.
- 9.3.6.1 An operator shall ensure that:
- 9.3.6.1.1 Each flight crew member undergoes recurrent training and checking and that all such training and checking is relevant to the type or variant of aeroplane on which the flight crew member operates.
- 9.3.6.1.2 A recurrent training and checking programme is established in the Operations Manual and approved by the CAAM.
- 9.3.6.1.3 The required recurrent training below shall be conducted by the following personnel:
- a) Ground and refresher training – by suitably qualified personnel.
 - b) Aeroplane/FSTD training - by the appropriate Flight Instructor (FI) which satisfies the operator's experience and knowledge requirements.
 - c) Emergency and safety equipment training – by suitably qualified personnel; and
 - d) Crew Resource Management (CRM):
 - 1) Integration of CRM elements into all their phases of the recurrent training - by all the personnel conducting recurrent training. The operator shall ensure that all personnel conducting recurrent training are suitably qualified to integrate elements of CRM into this training;
 - 2) Modular CRM training – by at least one CRM trainer acceptable to the CAAM who may be assisted by experts in order to address specific areas.
- 9.3.6.1.4 The required recurrent checking below shall be conducted by the following personnel:
- a) Proficiency check – by a CAAM Flight Operations Inspector, or a CAAM Designated Flight Examiner trained in CRM concepts and the assessment of CRM skills.
 - b) Line checks – by suitably qualified instructors nominated by the operator and acceptable to the CAAM.
 - c) Emergency and safety equipment checking – by suitably qualified personnel.
- 9.3.6.2 Line Check. An operator shall ensure that each flight crew member undergoes a line check on the aeroplane to demonstrate his competence in carrying out normal line operations described in the Operations Manual. The line check shall include a demonstration of adequate knowledge of the route or area to

be flown and of the aerodromes including alternate aerodromes, facilities and procedures to be used. A line check shall be valid to the end of the month which it is done, 12 calendar months later. If the line check renewal is carried out within the final 3 months of validity, the period of validity shall extend from the date of issue until 12 calendar months after the expiry date of the previous line check.

- 9.3.6.3 CRM. An operator shall ensure that:
- 9.3.6.3.1 Elements of CRM are integrated into all appropriate phases of the recurrent training, and
 - 9.3.6.3.2 Each flight crew member undergoes specific modular classroom CRM training. All major topics of CRM training shall be covered over a period not exceeding 3 years.
 - 9.3.6.3.3 An operator shall ensure that each flight crew member undergoes specific modular classroom CRM refresher training. The refresher training shall be valid to the end of the month which it is done, 12 calendar months later. If the subsequent refresher training is carried out within the final 3 months of validity, the period of validity shall extend from the date of that refresher training until 12 calendar months after the expiry date of the previous refresher training.
 - 9.3.6.4 Ground and Refresher training. An operator shall ensure that each flight crew member undergoes ground and refresher training. The training shall be valid to the end of the month which it is done, 12 calendar months later. If the subsequent refresher training is carried out within the final 3 months of validity, the period of validity shall extend from the date of that refresher training until 12 calendar months after the expiry date of the previous refresher training.
 - 9.3.6.5 Aeroplane/FSTD training.
 - a) An operator shall ensure that each flight crew member undergoes aeroplane/FSTD training at least every 12 calendar months. If the training is conducted within 3 calendar months prior to the expiry of the 12 calendar months period, the next aeroplane/FSTD training must be completed within 12 calendar months of the original expiry date of the previous aeroplane/STD training.
 - b) The aeroplane/FSTD training programme shall be established in a way that all major failures of aircraft systems and associated procedures will have been covered in the preceding 3 year period.
- 9.3.7 Command course
- 9.3.7.1 The command course shall include at least the following elements:

- a) training, theoretical knowledge examination and skill test for the issuance of a type rating as pilot-in-command, as required by 2.1.5 of CAD 1 – PEL;
 - 1) the training mentioned in 9.3.7.1 a) shall include line oriented flight training (LOFT) in a FSTD and/or flight training.
- b) command responsibilities training;
- c) line training as pilot-in-command under supervision, for a minimum of 10 flight sectors;
- d) completion of a line check as pilot-in-command and demonstration of adequate knowledge of the route or area to be flown and of the aerodromes including alternate aerodromes, facilities and procedures to be used; and
- e) CRM training.

Note. – For pilot-in-command training on the same type rating (e.g. P2 A320 to P1 A320), the theoretical knowledge requirements stated in 2.1.5.5 of CAD 1 – PEL are not applicable.

9.4 Qualifications

9.4.1 Recent experience — pilot-in-command and co-pilot

9.4.1.1 An operator shall ensure that:

- a) Flight crew is not assigned to operate an aeroplane as part of the minimum certificated crew, either as pilot flying or pilot monitoring, unless he has carried out three take-offs and three landings in the previous 90 days as pilot flying in an aeroplane, or in a flight simulator, of the same type/class.
- b) A pilot who does not hold a valid instrument rating is not assigned to operate an aeroplane at night as pilot-in-command unless he has carried out at least one landing at night in the preceding 90 days as pilot flying in an aeroplane, or in a flight simulator, of the same type/class.

9.4.1.2 An operator shall ensure that a flight crew member does not operate on more than one type or variant, unless: the flight crew member is competent to do so.

9.4.1.3 When considering operations of more than one type or variant, an operator shall ensure that the differences and/or similarities of the aeroplanes concerned justify such operations, taking account of the following:

- a) The level of technology.
- b) Operational procedures.
- c) Handling characteristics.

- 9.4.1.4 An Operator shall ensure that a flight crew member operating more than one type or variant complies with all of the requirements for each type or variant unless the CAAM has approved the use of credit(s) related to the training, checking and recent experience requirements.
- 9.4.1.5 An operator shall specify appropriate procedures and/or operational restrictions, approved by the CAAM, in the Operations Manual, for any operation on more than one type or variant covering:
- a) The flight level crew members' minimum experience level.
 - b) The minimum experience level on one type or variant before beginning training for and operation of another type or variant.
 - c) The process whereby flight crew qualified on one type or variant will be trained and qualified on another type or variant; and
 - d) All applicable recent experience requirements for each type or variant.
- 9.4.1.6 Where credits are sought to reduce the training and checking and recent experience requirements between aeroplane types, the operator must demonstrate to the CAAM which items need not be repeated on each type or variant because of similarities.
- 9.4.2 Recent experience — cruise relief pilot
- 9.4.2.1 A flight crew member may be relieved in flight of his duties at the controls by another suitably qualified flight crew member.
- 9.4.2.2 The operator shall not assign a pilot to act in the capacity of cruise relief pilot in a type or variant of a type of aeroplane unless, within the preceding 90 days that pilot has either:
- a) operated as a pilot-in-command, co-pilot or cruise relief pilot on the same type of aeroplane; or
 - b) carried out flying skill refresher training including normal, abnormal and emergency procedures specific to cruise flight on the same type of aeroplane or in a flight simulator approved for the purpose, and has practised approach and landing procedures, where the approach and landing procedure practice may be performed as the pilot who is not flying the aeroplane.
- 9.4.2.3 Relief of the pilot-in-command.
- a) The pilot-in-command may delegate conduct of the flight to:
 - 1) Another qualified pilot-in-command; or
 - 2) For operations only above FL200, a pilot who complies with the following minimum qualifications:

- i) Holder of valid Airline transport Pilot Licence (ATPL)
- ii) Has completed conversion training and checking (including type rating training/endorsement)
- iii) Has completed the required recurrent training and checking
- iv) Route/area and aerodrome competence in accordance to 9.4.3.2 of CAD 6.

9.4.2.4 The co-pilot may be relieved by another suitably qualified pilot.

9.4.2.5 Pilot qualification to operate in either pilot's seat.

9.4.2.5.1 An operator shall ensure that:

- a) A pilot who may be assigned to operate in either pilot's seat completes appropriate training and checking; and
- b) The training and checking programme is specified in the OM and is acceptable to the CAAM.

9.4.2.5.2 The additional training and checking shall include at least the following:

- a) an engine failure during take-off;
- b) a one-engine-inoperative approach and go-around; and
- c) a one-engine-inoperative landing.

9.4.2.5.3 When engine-out manoeuvres are carried out in an aircraft, the engine failure shall be simulated.

9.4.2.5.4 When operating in the co-pilot's seat, the checks required by 9.4.4 in this CAD for operating in the pilot-in-command seat shall, in addition, be valid and current.

9.4.3 Pilot-in-command area, route and aerodrome qualification

9.4.3.1 The operator shall not utilise a pilot as pilot-in-command of an aeroplane on a route or route segment for which that pilot is not currently qualified until such pilot has complied with 9.4.3.2 and 9.4.3.3.

9.4.3.2 Each such pilot shall demonstrate to the operator an adequate knowledge of:

- a) the route to be flown, and the aerodromes which are to be used. This shall include knowledge of:
 - 1) the terrain and minimum safe altitudes;
 - 2) the seasonal meteorological conditions;
 - 3) the meteorological, communication and air traffic facilities, services and procedures;
 - 4) the search and rescue procedures; and

- 5) the navigational facilities and procedures, including any long range navigation procedures, associated with the route along which the flight is to take place; and
- b) procedures applicable to flight paths over heavily populated areas and areas of high air traffic density, obstructions, physical layout, lighting, approach aids and arrival, departure, holding and instrument approach procedures, and applicable operating minima.

9.4.3.3 A pilot-in-command shall have made an actual approach into each aerodrome of landing on the route, accompanied by a pilot who is qualified for the aerodrome, as a member of the flight crew or as an observer on the flight deck, unless:

- a) the approach to the aerodrome is not over difficult terrain and the instrument approach procedures and aids available are similar to those with which the pilot is familiar, and a margin to be approved by the CAAM is added to the normal operating minima, or there is reasonable certainty that approach and landing can be made in visual meteorological conditions; or
- b) the descent from the initial approach altitude can be made by day in visual meteorological conditions; or
- c) the operator qualifies the pilot-in-command to land at the aerodrome concerned by means of an adequate pictorial presentation; or
- d) the aerodrome concerned is adjacent to another aerodrome at which the pilot-in-command is currently qualified to land.

9.4.3.4 The operator shall maintain a record, sufficient to satisfy the CAAM of the qualification of the pilot and of the manner in which such qualification has been achieved.

9.4.3.5 The operator shall not continue to utilise a pilot as a pilot-in-command on a route or within an area specified by the operator and approved by the CAAM unless, within the preceding 12 months, that pilot has made at least one trip as a pilot member of the flight crew, or as a check pilot, or as an observer in the flight crew compartment:

- a) within that specified area; and
- b) if appropriate, on any route where procedures associated with that route or with any aerodromes intended to be used for take-off or landing require the application of special skills or knowledge.

9.4.3.6 In the event that more than 12 months elapse in which a pilot-in-command has not made such a trip on a route in close proximity and over similar terrain, within such a specified area, route or aerodrome, and has not practised such procedures in a training device which is adequate for this purpose, prior to

again serving as a pilot-in-command within that area or on that route, that pilot must requalify in accordance with 9.4.3.2 and 9.4.3.3.

9.4.4 Pilot proficiency checks

9.4.4.1 The operator shall ensure that piloting technique and the ability to execute emergency procedures is checked in such a way as to demonstrate the pilot's competence on each type or variant of a type of aeroplane. Where the operation may be conducted under instrument flight rules, the operator shall ensure that the pilot's competence to comply with such rules is demonstrated to either a check pilot of the operator or to a representative of the CAAM. Such checks shall be performed twice within any period of one year. Any two such checks which are similar and which occur within a period of four consecutive months shall not alone satisfy this requirement.

9.4.4.2 Pilot proficiency checks are categorised as Licence Proficiency Checks (LPC) and Operator Proficiency Checks (OPC).

9.4.4.3 The period of validity of a LPC shall be valid in accordance with 2.1.5 of CAD 1 – PEL.

Note. – The period of validity of a LPC stated in 2.1.5 of CAD 1 - PEL, means if the pilot performs a proficiency check on 5th January 2018, the validity will expire by 23:59 hrs of 31 January 2019. While if the applicant performs a Licence Proficiency check within 3 months before the expiry (31 January 2019), the next Licence Proficiency check will expire by 31 January 2020 at 23:59 hrs.

9.4.4.4 Where an Instrument Rating Test (IRT) is required, the proficiency check shall be classified as a LPC.

9.4.4.5 To satisfy the requirements of a bi-annual proficiency check as required by paragraph 9.4.4.1, for the purpose of Commercial Air Transport, an OPC shall be carried out by the operator during the period of validity of the LPC. The OPC shall not be conducted earlier than 4 months after the LPC is conducted, and not later than 4 months before the LPC expiry date.

9.4.4.6 An operator shall ensure that:

- a) Each flight crew member undergoes proficiency checks to demonstrate his competence in carrying out normal, abnormal and emergency procedures; and
- b) The check is conducted without external visual reference when the flight crew member will be required to operate under IFR.
- c) Each flight crew member undergoes proficiency checks as part of a normal flight crew complement.

- 9.4.4.7 Where applicable, operator proficiency checks shall include the following manoeuvres:
- a) Rejected take-off when a Flight Simulator is available to represent that specific aeroplane, otherwise touch drills only.
 - b) Take-off with engine failure between V1 and V2 or as soon as safety considerations permit.
 - c) Precision instrument approach to minima with, in the case of multi-engined aeroplanes, one engine inoperative.
 - d) Non-precision approach to minima.
 - e) Missed approach on instruments from minima with, in the case of multi-engined aeroplanes, one engine inoperative; and
 - f) Landing with one engine inoperative. For single-engined aeroplanes a practice forced landing is required.
- 9.4.4.8 When engine out manoeuvres are carried out in an aeroplane, the engine failure must be simulated.
- 9.4.4.9 For a pilot operating VFR only, the checks prescribed in sub-paragraphs 9.4.4.7 c) to e) above may be omitted except for an approach and go-around in a multi-engined aeroplane with one engine inoperative.
- 9.4.4.10 Pilot proficiency checks shall be conducted by a CAAM Flight Operations Inspector or a CAAM Designated Flight Examiner
- 9.4.4.11 Notwithstanding 9.4.4.1, for flight crew rated on different variants of the same type of aeroplane with similar characteristics in terms of operating procedures, systems and handling, proficiency checks required by 9.4.4.1 may alternate between variants subject to the approval of the CAAM.
- 9.4.5 All operations involving single pilot under the instrument flight rules (IFR) or at night shall not be permitted in accordance with Regulation 49 of the MCAR 2016.

9.5 Flight crew equipment (Spare corrective lenses)

- 9.5.1 For provisions on flight crew equipment, refer to CAD 1004 Paragraph 9.14.

9.6 Attestation Certificate

- 9.6.1 Expiries stated in 4.11.12, 9.2.1.2, 9.3.6.2, 14.2.4 e) and 6.1.2 b) of CAD 19 shall be documented in an attestation certificate. The attestation certificate shall be issued by the operator.

Note. – Sample of Attestation Certificate is contained in CAGM 6009 – CC.

10 Flight Operations Officer/Flight Dispatcher

10.1 The CAAM accepts proof of qualifications and does not require a flight operations officer/flight dispatcher to be licenced. Such persons shall meet the requirements specified in CAD 1 for the Flight Operations Officer/Flight Dispatcher, in accordance with the approved method of control and supervision of flight operations.

10.2 A flight operations officer/flight dispatcher shall not be assigned to duty unless that person has:

- a) satisfactorily completed the operator-specific training course that addresses all the specific components of its approved method of control and supervision of flight operations specified in 4.2.1.3;

Note.— Guidance on the composition of such training syllabi is provided in the Training Manual (ICAO Doc 7192), Part D-3 — Flight Operations Officers/Flight Dispatchers.

- b) made, within the preceding 12 months, at least a one-way qualification flight in the flight crew compartment of an aeroplane over any area for which that individual is authorised to exercise flight supervision.

Note. – For the purpose of the qualification flight, the flight operations officer/flight dispatcher must be able to monitor the flight crew intercommunication system and radio communications, and be able to observe the actions of the flight crew.

- c) demonstrated to the operator a knowledge of:
 - 1) the contents of the operations manual described in Appendix 2;
 - 2) the radio equipment in the aeroplanes used; and
 - 3) the navigation equipment in the aeroplanes used;
- d) demonstrated to the operator a knowledge of the following details concerning operations for which the officer is responsible and areas in which that individual is authorised to exercise flight supervision:
 - 1) the seasonal meteorological conditions and the sources of meteorological information;
 - 2) the effects of meteorological conditions on radio reception in the aeroplanes used;
 - 3) the peculiarities and limitations of each navigation system which is used by the operation; and the aeroplane loading instructions;
- e) demonstrated to the operator knowledge and skills related to human performance relevant to dispatch duties; and
- f) demonstrated to the operator the ability to perform the duties specified in 4.6.



- 10.3 A flight operations officer/flight dispatcher assigned to duty shall maintain complete familiarisation with all features of the operation which are pertinent to such duties, including knowledge and skills related to human performance.

- 10.4 A flight operations officer/flight dispatcher shall not be assigned to duty after 12 consecutive months of absence from such duty, unless the provisions of 10.1.2 are met.

11 Manuals, logs and records

11.1 Flight manual

- 11.1.1 An operator shall keep a current approved flight manual or equivalent document for each aeroplane that it operates. The flight manual shall be updated by implementing changes made mandatory by the State of Registry.
- 11.1.2 An operator shall ensure that each of its aeroplane are operated in compliance with the terms of its Certificate of Airworthiness and within the approved limitations contained in its flight manual.
- 11.1.3 'Aircraft flight manual, or equivalent document(s)' means in the context of this directive the flight manual for the aircraft, or other documents containing information required for the operation of the aircraft within the terms of its certificate of airworthiness unless these data are available in the parts of the operations manual carried on board.

11.2 Operator's continuing airworthiness management exposition

- 11.2.1 The continuing airworthiness management exposition provided in accordance with 8.2, which may be issued in separate parts, shall contain the following information but not limited to the following:
- a) a description of the procedures required by 8.1.1 including, when applicable:
 - b) a description of the administrative arrangements between the operator and the approved maintenance organisation;
 - c) names and duties of the person or persons required by 8.1.4;
 - d) a reference to the maintenance programme required by 8.3.1;
 - e) a description of the methods used for the completion and retention of the operator's continuing airworthiness records required by 8.4;
 - f) a description of the procedures for monitoring, assessing and reporting maintenance and operational experience required by 8.5.1;
 - g) a description of the procedures for complying with the service information reporting requirements;
 - h) a description of procedures for assessing continuing airworthiness information and implementing any resulting actions, as required by 8.5.2;
 - i) a description of the procedures for implementing action resulting from mandatory continuing airworthiness information;
 - j) a description of establishing and maintaining a system of analysis and continued monitoring of the performance and efficiency of the maintenance programme, in order to correct any deficiency in that programme;

- k) a description of aircraft types and models to which the exposition applies;
- l) a description of procedures for ensuring that un-serviceabilities affecting airworthiness are recorded and rectified; and
- m) a description of the procedures for advising CAAM of significant in-service occurrences.

11.3 Maintenance programme

- 11.3.1 A maintenance programme for each aeroplane as required by 8.3 shall contain the following information:
 - a) maintenance tasks and the intervals at which these are to be performed, taking into account the anticipated utilisation of the aeroplane;
 - b) when applicable, a continuing structural integrity programme;
 - c) procedures for changing or deviating from a) and b) above; and
 - d) when applicable, condition monitoring and reliability programme descriptions for aircraft systems, components and engines.
- 11.3.2 Maintenance tasks and intervals that have been specified as mandatory in approval of the type design shall be identified as such.
- 11.3.3 The maintenance programme should be based on maintenance programme information made available by the State of Design or by the organisation responsible for the type design, and any additional applicable experience.

11.4 Journey Log Book

- 11.4.1 An operator shall contain the following information for each flight in the form of a Journey Log:
 - a) Aeroplane registration.
 - b) Date.
 - c) Name(s) crew member(s).
 - d) Duty assignments of crew member(s).
 - e) Place of departure.
 - f) Place of arrival.
 - g) Time of departure (off-block time).
 - h) Time of arrival (on-block time).
 - i) Hours of flight.
 - j) Nature of flight.

- k) Incidents, observations (if any); and
- l) Pilot-in-command signature.

11.4.2 Notwithstanding 11.4.4, items in 11.4.1 c) and d) may be recorded in documentation other than the Journey Log book, such as the operational flight plan or an operator voyage report.

11.4.3 An operator shall ensure that all entries are made concurrently and that they are permanent in nature.

11.4.4 Completed journey log book shall be retained to provide a continuous record of the last six (6) months' operations.

11.5 Records of emergency and survival equipment carried

11.5.1 An operator shall ensure that there are available for immediate communication to rescue coordination centres, lists containing information on the emergency and survival equipment carried on board all of his aeroplanes. The information shall include, as applicable, the number, colour and type of life-rafts and pyrotechnics, details of emergency medical supplies, water supplies and the type and frequencies of emergency portable radio equipment.

11.6 Flight recorder records

11.6.1 Preservation, production and use of flight recorder recordings.

11.6.1.1 Preservation of recordings.

- a) Following an accident, the operator of an aeroplane on which a flight recorder is carried shall, to the extent possible, preserve the original recorded data pertaining to that accident, as retained by the recorder for a period of 60 days unless otherwise directed by the investigating authority.
- b) Unless prior permission has been granted by the CAAM, following an incident that is subject to mandatory reporting, the operator of an aeroplane on which a flight recorder is carried shall, to the extent possible, preserve the original recorded data pertaining to that incident, as retained by the recorder for a period of 60 days unless otherwise directed by the investigating authority.
- c) Additionally, when the CAAM so directs, the operator of an aeroplane on which a flight recorder is carried shall preserve the original recorded data for a period of 60 days unless otherwise directed by the investigating authority.
- d) When a flight data recorder is required to be carried aboard an aeroplane, the operator of that aeroplane shall:

- 1) Save the recordings for the period of operating time as required by 6.3.1.3.1; and
- 2) Keep a document which presents the information necessary to retrieve and convert the stored data into engineering units.

11.6.1.2 Production of recordings

- a) The operator of an aeroplane on which a flight recorder is carried shall, within a reasonable time after being requested to do so by the CAAM, produce any recording made by a flight recorder which is available or has been preserved.

11.6.1.3 Use of recordings

- a) The cockpit voice recorder recordings may not be used for purposes other than for the investigation of an accident or incident subject to mandatory reporting except with the consent of all crew members concerned.
- b) The flight data recorder recordings may not be used for purposes other than for the investigation of an accident or incident subject to mandatory reporting except when such records are:
 - 1) Used by the operator for airworthiness or maintenance purposes only; or
 - 2) De-identified; or
 - 3) Disclosed under secure procedures.

11.7 Information to be retained on the ground

11.7.1 The operator shall ensure that at least for the duration of each flight or series of flights:

- a) information relevant to the flight and appropriate for the type of operation is preserved on the ground; and
- b) the information is retained until it has been duplicated at the place at which it will be stored.

11.7.2 The information referred to in 11.7.1 includes:

- a) a copy of the operational flight plan, where appropriate;
- b) copies of the relevant part(s) of the aircraft journey log;
- c) route-specific NOTAM documentation if specifically edited by the operator;
- d) mass and balance documentation if required; and
- e) special loads notification.

12 Cabin Crew

In addition to the following paragraphs, the operator shall comply with CAD 6009 – Cabin Crew for all matters related to the duties and responsibilities of a cabin crew member.

Note. – Guidance material can be found in CAGM 6009 – Cabin Crew.

12.1 Assignment of emergency duties

12.1.1 The operator shall establish, to the satisfaction of the CAAM, the minimum number of cabin crew required for each type of aeroplane, based on seating capacity or the number of passengers carried, in order to effect a safe and expeditious evacuation of the aeroplane, and the necessary functions to be performed in an emergency or a situation requiring emergency evacuation. The operator shall assign these functions for each type of aeroplane.

12.2 Cabin crew at emergency evacuation stations

12.2.1 Each cabin crew member assigned to emergency evacuation duties shall occupy a seat provided in accordance with 6.16 during take-off and landing and whenever the pilot-in-command so directs.

12.3 Protection of cabin crew during flight

12.3.1 Each cabin crew member shall be seated with seat belt or, when provided, safety harness fastened during take-off and landing and whenever the pilot-in-command so directs.

Note. – The foregoing does not preclude the pilot-in-command from directing the fastening of the seat belt only, at times other than during take-off and landing.

12.4 Training

12.4.1 The operator shall establish and maintain a training programme, approved by the CAAM, to be completed by all persons before being assigned as a cabin crew member. Cabin crew members shall complete a recurrent training programme annually. These training programmes shall ensure that each person is:

- a) competent to execute those safety duties and functions which the cabin crew member is assigned to perform in the event of an emergency or in a situation requiring emergency evacuation;
- b) drilled and capable in the use of emergency and life-saving equipment required to be carried, such as life jackets, life rafts, evacuation slides, emergency exits, portable fire extinguishers, oxygen equipment, first-aid and universal precaution kits, and automated external defibrillators;
- c) when serving on aeroplanes operated above 3 000 m (10 000 ft), knowledgeable as regards the effect of lack of oxygen and, in the case of

pressurised aeroplanes, as regards physiological phenomena accompanying a loss of pressurisation;

- d) aware of other crew members' assignments and functions in the event of an emergency so far as is necessary for the fulfilment of the cabin crew member's own duties;
- e) aware of the types of dangerous goods which may, and may not, be carried in a passenger cabin; and
- f) knowledgeable about human performance as related to passenger cabin safety duties including flight crew-cabin crew coordination.

Note 1.— Guidance material to design training programmes to develop knowledge and skills in human performance can be found in the Cabin Crew Safety Training Manual (ICAO Doc 10002).

13 Security

13.1 Domestic commercial operations

- 13.1.1 Domestic flight means a flight with origin and destination within the borders of Malaysia.
- 13.1.2 A domestic operator shall implement the directives set forth in this CAD and CAD 17 when conducting domestic commercial operations.

13.2 Security of the flight crew compartment

13.2.1 In all aeroplanes which are equipped with a flight crew compartment door, this door shall be capable of being locked, and means shall be provided by which cabin crew can discreetly notify the flight crew in the event of suspicious activity or security breaches in the cabin. The door must have a placard indicating “CREW ONLY”

13.2.2 All passenger-carrying aeroplanes:

- a) of a maximum certificated take-off mass in excess of 54 500 kg; or
- b) of a maximum certificated take-off mass in excess of 45 500 kg with a maximum approved passenger seating configuration greater than 19; or
- c) with a maximum approved passenger seating configuration greater than 60

shall be equipped with an approved flight crew compartment door that is designed to resist penetration by small arms fire and grenade shrapnel, and to resist forcible intrusions by unauthorised persons. This door shall be capable of being locked and unlocked from either pilot’s station.

13.2.3 In all aeroplanes which are equipped with a flight crew compartment door in accordance with 13.2.2:

- a) this door shall be closed and locked from the time all external doors are closed following embarkation until any such door is opened for disembarkation, except when necessary to permit access and egress by authorised persons; and
- b) means shall be provided for monitoring from either pilot’s station the entire door area outside the flight crew compartment to identify persons requesting entry and to detect suspicious behaviour or potential threat.

Note – Authorised persons include CAAM Flight Operation Inspectors with the authority of the Chief Executive Officer, performing any regulatory functions, including witnessing any training, practice or test for the purpose of the Act, or for the purpose of the Civil Aviation Authority of Malaysia Act 2017 (ACT 788).

13.2.4 Pursuant to Regulation 25 of Civil Aviation (Security) Regulations 2019, only authorised personnel shall be allowed in the flight crew compartment.

13.3 Aeroplane search procedure checklist

- 13.3.1 An operator shall ensure that there is on board a checklist of the procedures to be followed in search of a bomb or Improvised Explosive Device (IED) in case of suspected sabotage and for inspecting aeroplanes for concealed weapons, explosives or other dangerous devices where a well-founded suspicion exists that the aeroplane may be the object of an act of unlawful interference. The checklist shall be supported by guidance on the appropriate course of action to be taken shall a bomb or suspicious object be found and information on the least-risk bomb location specific to the aeroplane.
- 13.3.2 An operator shall ensure the availability of security instructions and guidance of a non-confidential nature which must include the CAAM and responsibilities of operations personnel. Policies and procedures for handling and reporting crime on board such as unlawful interference, sabotage, bomb threats, and hijacking must also be included.

13.4 Training programmes

- 13.4.1 Security Training Programme For Crew Members.
- 13.4.1.1 Pursuant to Regulation 9 of Civil Aviation (Security) Regulation 2019, an operator shall establish and maintain a security training programme for crew members, including theoretical and practical elements. This training shall be provided at the time of operator conversion training and thereafter at intervals not exceeding three years. The content and duration of the training shall be adapted to the security threats of the individual operator and shall ensure that crew members act in the most appropriate manner to minimise the consequences of acts of unlawful interference. This programme shall include the following elements:
- a) determination of the seriousness of the occurrence.
 - b) crew communication and coordination.
 - c) appropriate self-defence responses.
 - d) use of non-lethal protective devices assigned to crew members whose use is authorised by the Member State.
 - e) understanding of behaviour of terrorists so as to facilitate the ability of crew members to cope with hijacker behaviour and passenger responses.
 - f) in case where cabin crew are required, live situational training exercises regarding various threat conditions.
 - g) flight crew compartment procedures to protect the aeroplane.
 - h) aeroplane search procedures, including identification of prohibited articles; and

- i) guidance on the least risk bomb locations.

13.4.1.2 Pursuant to Regulation 9 of Civil Aviation (Security) Regulation 2019, an operator shall establish and maintain a security training programme for ground personnel to acquaint appropriate employees with preventive measures and techniques in relation to passengers, baggage, cargo, mail, equipment, stores and supplies intended for carriage so that they contribute to the prevention of acts of sabotage or other forms of unlawful interference.

13.5 Reporting acts of unlawful interference

13.5.1 Following an act of unlawful interference on board an aeroplane the pilot-in-command or, in his absence the operator, shall submit, without delay, a report of such an act to the designated local authority and the CAAM.

13.6 Miscellaneous

13.6.1 Carriage of weapons of war and munitions of war.

13.6.1.1 An operator shall not transport weapons of war and munitions of war by air unless an approval to do so has been granted by all States concerned.

13.6.1.2 An operator shall ensure that weapons of war and munitions of war are:

- a) Stowed in the aeroplane in a place which is inaccessible to passengers during flight; and
- b) In the case of firearms, unloaded.

13.6.1.3 An operator shall ensure that the pilot-in-command is notified before a flight begins of the details and location on board the aeroplane of any weapons of war and munitions of war intended to be carried.



INTENTIONALLY LEFT BLANK

14 Dangerous goods

In addition to the following paragraphs, the operator shall comply with CAD 18.

14.1 State responsibilities

14.1.1 All Malaysian air operators shall be subject to inspection, surveillance and enforcement procedures for performing any function prescribed in CAD 18 for air transport of dangerous goods with a view to achieving compliance with those directives.

Note 1: It is envisaged that these procedures would include provisions for:

- inspecting dangerous goods consignments prepared, offered, accepted or transported by the operators.
- inspecting the practices of the operators, and
- investigating alleged violations.

Note 2: Guidance on dangerous goods inspections and enforcement may be found in the Supplement to the Technical Instructions (Part S-5, Chapter 1 and Part S-7, Chapters 5 and 6).

14.2 Operators with no specific approval to transport dangerous goods as cargo

14.2.1 An operator must comply with the applicable provisions contained in the Technical Instructions, irrespective of whether:

- a) the flight is wholly or partly within or wholly outside the territory of a state; or
- b) an approval to carry dangerous goods in accordance with Paragraph 14.3.1 is held.

14.2.2 An operator shall establish dangerous goods policies and procedures in its operations manual to allow operator personnel to:

- a) identify and reject undeclared dangerous goods, including COMAT classified as dangerous goods; and
- b) report to the CAAM and the State in which it occurred any:
 - 1) occasions when undeclared dangerous goods are discovered in cargo or mail; and
 - 2) dangerous goods accidents and incidents. An operator shall ensure that articles and substances (or other goods declared as dangerous goods) that are specifically identified by name or [generally described in the Technical Instructions as being forbidden for transport under any circumstances are not carried on any aeroplane.

14.2.3 An operator shall not carry articles and substances or other goods declared as dangerous goods that are identified in the Technical Instructions as being

forbidden for transport in normal circumstances unless the following requirements of those Instructions have been met:

- a) The necessary exemptions have been granted by all the States concerned under the requirements of the Technical Instructions; or
- b) An approval [has been granted by all the State(s) concerned on those occasions when the Technical Instructions indicate that only such approval is required.

14.2.4 Training programmes.

- a) An operator shall establish and maintain staff training programmes, as required by the Technical Instructions, which shall be approved by the CAAM and included in the operations manual.
- b) An operator must ensure that staff receive training in the requirements commensurate with their responsibilities.
- c) An operator must ensure that training is provided or verified upon the employment of a person in a position involving the transport of dangerous goods by air.
- d) An operator shall ensure that all staff who receive training undertake a test to verify understanding of their responsibilities.
- e) An operator shall ensure that all staff who require dangerous goods training receive recurrent training at intervals of no longer than 2 years.
- f) An operator shall ensure that records of dangerous goods training are maintained for all staff as required by the Technical Instructions.
- g) An operator shall ensure that his handling agent's staff are trained as required by the Technical Instructions.

14.2.5 Information to Passengers and Other Persons.

- a) An operator shall ensure that information is promulgated as required by the Technical Instructions so that passengers are warned as to the types of goods which they are forbidden from transporting aboard an aeroplane; and
- b) An operator shall ensure that notices are provided at acceptance points for cargo giving information about the transport of dangerous goods.

14.2.6 Information in the Event of an Aeroplane Incident or Accident.

- a) The operator of an aeroplane which is involved in an aeroplane incident shall, on request, provide any information as required by the Technical Instructions.
- b) The operator of an aeroplane which is involved in an aeroplane accident or serious incident shall without delay, provide any information as required by the Technical Instructions.

- c) The operator of an aeroplane shall include procedures in appropriate manuals and accident contingency plans to enable this information to be provided.

14.2.7 Dangerous goods incident and accident reports.

14.2.7.1 An operator shall ensure that any type of dangerous goods incident or accident is reported, irrespective of whether the dangerous goods are contained in cargo, mail, passengers' baggage or crew baggage. The finding of undeclared or mis-declared dangerous goods in cargo, mail or baggage shall also be reported.

14.2.7.2 The first report shall be despatched within 72 hours of the event unless exceptional circumstances prevent this. It may be sent by any means, including e-mail, telephone or fax. This report shall include the details that are known at that time, under the headings identified in paragraph 3. If necessary, a subsequent report shall be made as soon as possible giving all the details that were not known at the time the first report was sent. If a report has been made verbally, written confirmation shall be sent as soon as possible.

14.2.7.3 The first and any subsequent report shall be as precise as possible and contain such of the following data that are relevant:

- a) Date of the incident or accident or the finding of undeclared or mis-declared dangerous goods.
- b) Location, the flight number and flight date.
- c) Description of the goods and the reference number of the air waybill, pouch, baggage tag, ticket, etc
- d) Proper shipping name (including the technical name, if appropriate) and UN/ID number, when known.
- e) Class or division and any subsidiary risk.
- f) Type of packaging, and the packaging specification marking on it.
- g) Quantity.
- h) Name and address of the shipper, passenger, etc.
- i) Any other relevant details.
- j) Suspected cause of the incident or accident.
- k) Action taken.
- l) Any other reporting action taken; and
- m) Name, title, address and telephone number of the person making the report.

14.2.7.4 Copies of relevant documents and any photographs if taken shall be attached to a report.

14.3 Operators with specific approval for the transport of dangerous goods as cargo

14.3.1 Approval to Transport Dangerous Goods.

14.3.1.1 An operator shall not transport dangerous goods unless approved to do so by the CAAM.

14.3.1.2 Before the issue of an approval for the transport of dangerous goods, the operator shall satisfy the CAAM that adequate training has been given, that all relevant documents (e.g. for ground handling, aeroplane handling, training) contain information and instructions on dangerous goods, and that there are procedures in place to ensure the safe handling of dangerous goods at all stages of air transport.

14.3.1.3 The operator shall establish dangerous goods policies and procedures in its operations manual to enable operators personnel to:

- a) identify and reject undeclared or misdeclared dangerous goods, including COMAT classified as dangerous goods;
- b) report to the CAAM and the State in which it occurred any:
 - 1) occasions when undeclared or misdeclared dangerous goods are discovered in cargo or mail; and
 - 2) dangerous goods accidents and incidents;
- c) report to the CAAM and the State of Origin any occasions when dangerous goods are discovered to have been carried:
 - 1) when not loaded, segregated, separated or secured in accordance with the Technical Instructions; and
 - 2) without information having been provided to the pilot-in-command;
- d) accept, handle, store, transport, load and unload dangerous goods, including COMAT classified as dangerous goods as cargo on board an aircraft; and
- e) provide the pilot-in-command with accurate and legible written or printed information concerning dangerous goods that are to be carried as cargo.

14.3.1.4 Terms used in this Chapter have the following meanings:

- a) Acceptance Check List. A document used to assist in carrying out a check on the external appearance of packages of dangerous goods and their

- associated documents to determine that all appropriate requirements have been met.
- b) Approval. For the purposes only of compliance with Paragraph 14.3.2.2 (2), an authorisation referred to in the Technical Instructions and issued by the CAAM, for the transport of dangerous goods which are normally forbidden for transport or for other reasons, as specified in the Technical Instructions.
 - c) Cargo Aircraft. Any aircraft which is carrying goods or property but not passengers. In this context the following are not considered to be passengers:
 - 1) A crew member.
 - 2) An operator's employee permitted by, and carried in accordance with, the instructions contained in the Operations Manual.
 - 3) An authorised representative of the CAAM; or
 - 4) A person with duties in respect of a particular shipment on board.
 - d) Dangerous Goods. Articles or substances which are capable of posing a risk to health, safety, property or the environment and which are shown in the list of dangerous goods in the Technical Instructions or which are classified according to those Instructions.
 - e) Dangerous Goods Accident. An occurrence associated with and related to the transport of dangerous goods which results in fatal or serious injury to a person or major property damage.
 - f) Dangerous Goods Incident. An occurrence, other than a dangerous goods accident, associated with and related to the transport of dangerous goods, not necessarily occurring on board an aircraft, which results in injury to a person, property damage, fire, breakage, spillage, leakage of fluid or radiation or other evidence that the integrity of the packaging has not been maintained. Any occurrence relating to the transport of dangerous goods which seriously jeopardises the aircraft or its occupants is also deemed to constitute a dangerous goods incident.
 - g) Dangerous Goods Transport Document. A document which is specified by the Technical Instructions. It is completed by the person who offers dangerous goods for air transport and contains information about those dangerous goods.
 - h) Exemption. For the purposes only of compliance with this Chapter, an authorisation referred to in the Technical Instructions and issued by all the authorities concerned, providing relief from the requirements of the Technical Instructions.
 - i) Freight Container. A freight container is an article of transport equipment for radioactive materials, designed to facilitate the transport of such

- materials, either packaged or unpackaged, by one or more modes of transport. (Note: see Unit Load Device where the dangerous goods are not radioactive materials.)
- j) Handling Agent. An agency which performs on behalf of the operator some or all of the latter's functions including receiving, loading, unloading, transferring or other processing of passengers or cargo.
 - k) Overpack. An enclosure used by a single shipper to contain one or more packages and to form one handling unit for convenience of handling and stowage. (Note: a unit load device is not included in this definition.)
 - l) Package. The complete product of the packing operation consisting of the packaging and its contents prepared for transport.
 - m) Packaging. Receptacles and any other components or materials necessary for the receptacle to perform its containment function.
 - n) Serious Injury. An injury which is sustained by a person in an accident and which:
 - 1) Requires hospitalisation for more than 48 hours, commencing within seven days from the date the injury was received; or
 - 2) Results in a fracture of any bone (except simple fractures of fingers, toes or nose); or
 - 3) Involves lacerations which cause severe haemorrhage, nerve, muscle or tendon damage; or
 - 4) Involves injury to any internal organ; or
 - 5) Involves second or third degree burns, or any burns affecting more than 5% of the body surface; or
 - 6) Involves verified exposure to infectious substances or injurious radiation.
 - o) Technical Instructions. The latest effective edition of the Technical Instructions for the Safe Transport of Dangerous Goods by Air, including the Supplement and any Addendum, approved and published by decision of the Council of the International Civil Aviation Organisation. (Doc 9284–AN/905).
 - p) Unit Load Device. Any type of aircraft container, aircraft pallet with a net, or aircraft pallet with a net over an igloo. (Note: an overpack is not included in this definition; for a container containing radioactive materials see the definition for freight container.)

14.3.2 Limitations on the Transport of Dangerous Goods.

- 14.3.2.1 An operator shall ensure that articles and substances [or other goods declared as dangerous goods] that are specifically identified by name or generally

described in the Technical Instructions as being forbidden for transport under any circumstances are not carried on any of its aeroplane.

14.3.2.2 An operator shall not carry articles and substances or other goods declared as dangerous goods that are identified in the Technical Instructions as being forbidden for transport in normal circumstances unless the following requirements of those Instructions have been met:

- (1) The necessary exemptions have been granted by all the States concerned under the requirements of the Technical Instructions;
or
- (2) An approval [has been granted by all the State(s) concerned on those occasions when the Technical Instructions indicate that only such approval is required.]

14.3.3 Dangerous Goods Training programmes.

14.3.3.1 An operator shall establish and maintain staff training programmes, as required by the Technical Instructions, which shall be approved by the CAAM as described in 14.2.4

14.3.4 An operator shall establish policies and procedures to ensure that all reasonable measures are taken to prevent dangerous goods from being carried on board inadvertently.

14.3.5 The operator shall, in accordance with the technical instructions, report without delay to the CAAM and the appropriate authority of the State of occurrence in the event of:

- a) any dangerous goods accidents or incidents.
- b) the discovery of undeclared or misdeclared dangerous goods in cargo or mail; or
- c) the finding of dangerous goods carried by passengers or crew members, or in their baggage, when not in accordance with Part 8 of the Technical Instructions.

14.4 Provision of information

14.4.1 Procedures and information to personnel and passengers.

14.4.1.1 Personnel shall be trained to get familiarised with the items that are allowed or forbidden on board to an extent that they can inform the passengers accordingly. An updated list of permitted items under Part 8 of the T. I. shall be available to the personnel. This can be a poster, a leaflet or anything that can be easily understood and shown to the passengers when needed. This list shall also specify the items that are forbidden under all circumstances as established in Part 8 of the T.I.

- 14.4.1.2 Information shall be given to the passengers as regards goods that are forbidden to take on board before the flight takes place. This can be done in the website where the ticket is bought or in a summary written on the physical ticket that is given to the passenger. In case this is not possible, the crew can provide this information in a briefing before the flight.
- 14.4.1.3 An operator shall provide information in the operations manual to enable the pilot-in-command and other personnel to carry out their responsibilities and identify which dangerous goods can be allowed on board.
- 14.4.1.4 Procedures shall also be established and described in the operations manual to respond to accidents or incidents involving dangerous goods. The relevant personnel shall be familiar with them.

14.5 Domestic commercial air transport operations

- 14.5.1 Domestic commercial civil aircraft operations.
 - 14.5.1.1 In the interests of safety and of minimising interruptions to the international transport of dangerous goods, all domestic commercial civil aircraft operators should also take the necessary measures to achieve compliance with CAD 18 and the Technical Instructions.

15 Cargo Compartment Safety

15.1 Transport Of Items In The Cargo Compartment

- 15.1.1 The operator shall establish policies and procedures for the transport of items in the cargo compartment, which include the conduct of a specific safety risk assessment. The risk assessment shall include at least the:
- a) hazards associated with the properties of the items to be transported;
 - b) capabilities of the operator;
 - c) operational considerations (e.g. area of operations, diversion time);
 - d) capabilities of the aeroplane and its systems (e.g. cargo compartment fire suppression capabilities);
 - e) containment characteristics of unit load devices;
 - f) packing and packaging;
 - g) safety of the supply chain for items to be transported; and
 - h) quantity and distribution of dangerous goods items to be transported.

15.2 Fire Protection

- 15.2.1 The elements of the cargo compartment(s) fire protection system shall be provided in the aeroplane flight manual or other documentation supporting the operation of the aeroplane.
- 15.2.2 The Operator shall establish policies and procedures that address the items to be transported in the cargo compartment. These shall ensure, to a reasonable certainty, that in the event of a fire involving those items, it can be detected and sufficiently suppressed or contained by the elements of the aeroplane design associated with cargo compartment fire protection, until the aeroplane makes a safe landing.

Note.— Guidance on the elements of cargo compartment fire protection and associated demonstrated standards are provided in the Guidance for Safe Operations Involving Cargo Compartments (ICAO Doc 10102).



INTENTIONALLY LEFT BLANK

16 Appendices

16.1 Appendix 1 – Lights to be displayed by aeroplanes

Note. – (Chapter 6, 6.10 refers)

1 TERMINOLOGY

1.1 When the following terms are used in this Appendix, they have the following meanings:

1 **Angles of coverage.**

- a) Angle of coverage A is formed by two intersecting vertical planes making angles of 70 degrees to the right and 70 degrees to the left respectively, looking aft along the longitudinal axis to a vertical plane passing through the longitudinal axis.
- b) Angle of coverage F is formed by two intersecting vertical planes making angles of 110 degrees to the right and 110 degrees to the left respectively, looking forward along the longitudinal axis to a vertical plane passing through the longitudinal axis.
- c) Angle of coverage L is formed by two intersecting vertical planes, one parallel to the longitudinal axis of the aeroplane, and the other 110 degrees to the left of the first, when looking forward along the longitudinal axis.
- d) Angle of coverage R is formed by two intersecting vertical planes, one parallel to the longitudinal axis of the aeroplane, and the other 110 degrees to the right of the first, when looking forward along the longitudinal axis.

Horizontal plane. The plane containing the longitudinal axis and perpendicular to the plane of symmetry of the aeroplane. Longitudinal axis of the aeroplane. A selected axis parallel to the direction of flight at a normal cruising speed and passing through the centre of gravity of the aeroplane.

Making way. An aeroplane on the surface of the water is “making way” when it is under way and has a velocity relative to the water.

Under command. An aeroplane on the surface of the water is “under command” when it is able to execute manoeuvres as required by the International Regulations for Preventing Collisions at Sea for the purpose of avoiding other vessels.

Under way. An aeroplane on the surface of the water is “under way” when it is not aground or moored to the ground or to any fixed object on the land or in the water.

Vertical planes. Planes perpendicular to the horizontal plane.

Visible. Visible on a dark night with a clear atmosphere.

2 NAVIGATION LIGHTS TO BE DISPLAYED IN THE AIR

Note. — *The lights specified herein are intended to meet the requirements of CAD 2 for navigation lights.*

- 2.1 As illustrated in Figure 1, the following unobstructed navigation lights shall be displayed:
- a) a red light projected above and below the horizontal plane through angle of coverage L;
 - b) a green light projected above and below the horizontal plane through angle of coverage R;

- c) a white light projected above and below the horizontal plane rearward through angle of coverage A.

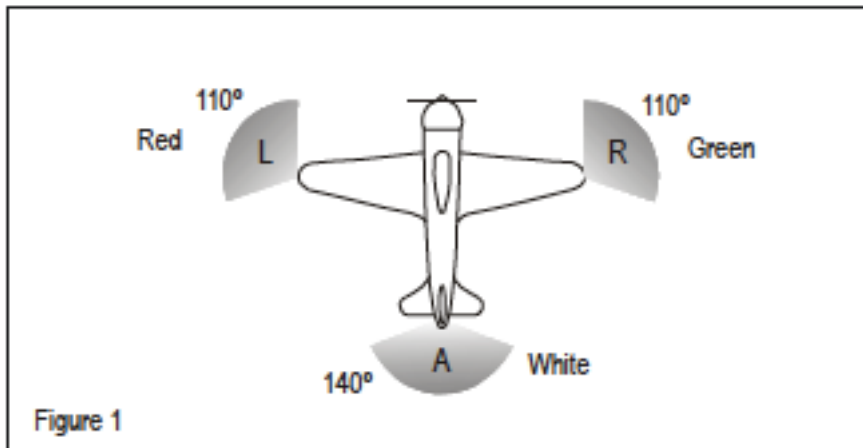

3 LIGHTS TO BE DISPLAYED ON THE WATER

3.1 General

Note. — The lights specified herein are intended to meet the requirements of CAD 2 for lights to be displayed by aeroplanes on the water.

3.1.1 The International Regulations for Preventing Collisions at Sea require different lights to be displayed in each of the following circumstances:

- a) when under way;
- b) when towing another vessel or aeroplane;
- c) when being towed;
- d) when not under command and not making way;
- e) when making way but not under command;
- f) when at anchor;
- g) when aground.

3.1.2 The lights required by aeroplanes in each case are described below.

3.2 When under way

3.2.1 As illustrated in Figure 2, the following appearing as steady unobstructed lights:

- a) a red light projected above and below the horizontal through angle of coverage L;
- b) a green light projected above and below the horizontal through angle of coverage R;
- c) a white light projected above and below the horizontal through angle of coverage A; and
- d) a white light projected through angle of coverage F.

3.2.2 The lights described in 3.2.1 a), b) and c) should be visible at a distance of at least 3.7 km (2 NM). The light described in 3.2.1 d) should be visible at a distance of 9.3 km (5 NM) when fitted to an aeroplane of 20 m or more in length or visible at a distance of 5.6 km (3 NM) when fitted to an aeroplane of less than 20 m in length.

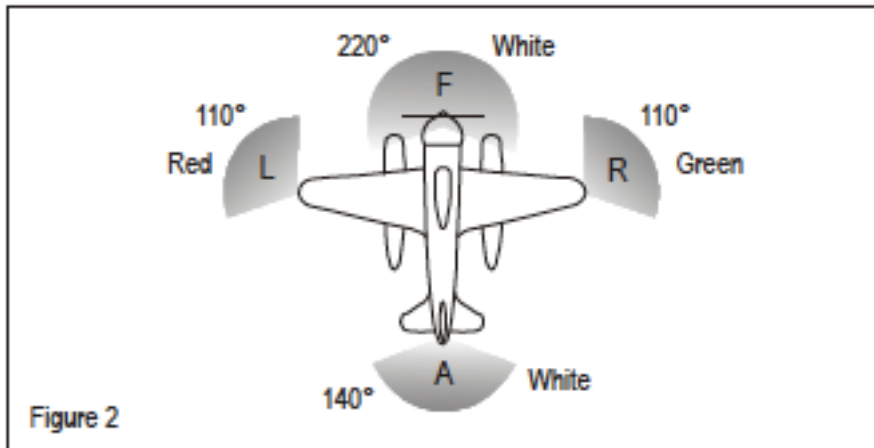

3.3 When towing another vessel or aeroplane

3.3.1 As illustrated in Figure 3, the following appearing as steady, unobstructed lights:

- a) the lights described in 3.2.1;
- b) a second light having the same characteristics as the light described in 3.2.1 d) and mounted in a vertical line at least 2 m above or below it; and
- c) a yellow light having otherwise the same characteristics as the light described in 3.2.1 c) and mounted in a vertical line at least 2 m above it.

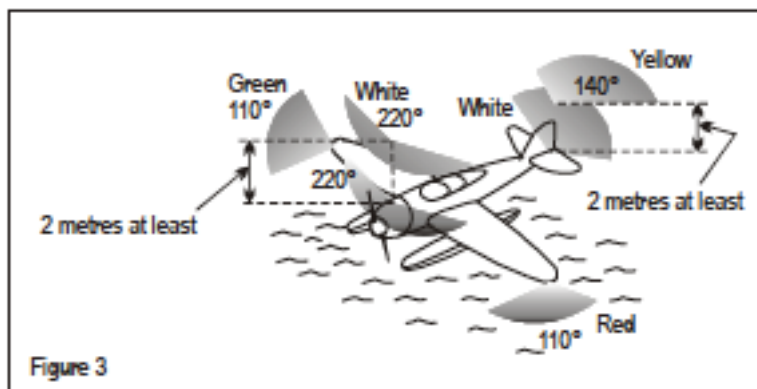

3.4 When being towed

3.4.1 The lights described in 3.2.1 a), b) and c) appearing as steady, unobstructed lights.

3.5 When not under command and not making way

3.5.1 As illustrated in Figure 4, two steady red lights placed where they can best be seen, one vertically over the other and not less than 1 m apart, and of such a character as to be visible all around the horizon at a distance of at least 3.7 km (2 NM).

3.6 When making way but not under command

3.6.1 As illustrated in Figure 5, the lights described in 3.5.1 plus the lights described in 3.2.1 a), b) and c).

Note. — The display of lights prescribed in 3.5.1 and 3.6.1 is to be taken by other aircraft as signals that the aeroplane showing them is not under command and cannot therefore get out of the way. They are not signals of aeroplanes in distress and requiring assistance.

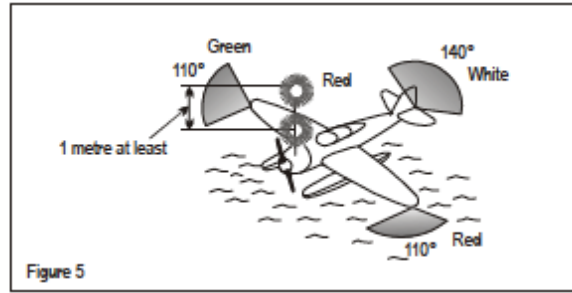
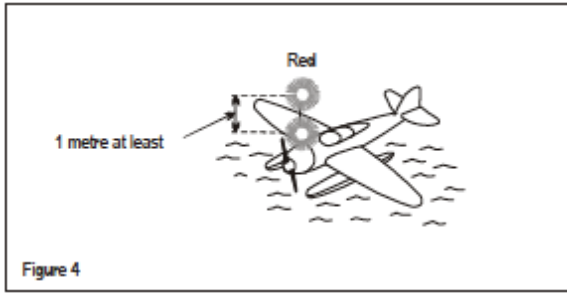

3.7 When at anchor

- a) If less than 50 m in length, where it can best be seen, a steady white light (Figure 6), visible all around the horizon at a distance of at least 3.7 km (2 NM).
- b) If 50 m or more in length, where they can best be seen, a steady white forward light and a steady white rear light (Figure 7) both visible all around the horizon at a distance of at least 5.6 km (3 NM).
- c) If 50 m or more in span a steady white light on each side (Figures 8 and 9) to indicate the maximum span and visible, so far as practicable, all around the horizon at a distance of at least 1.9 km (1 NM).

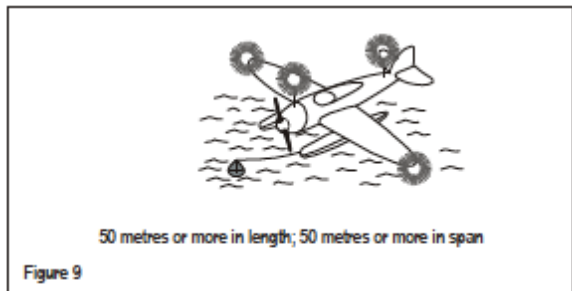
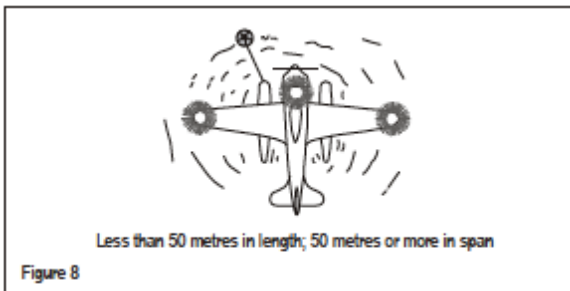
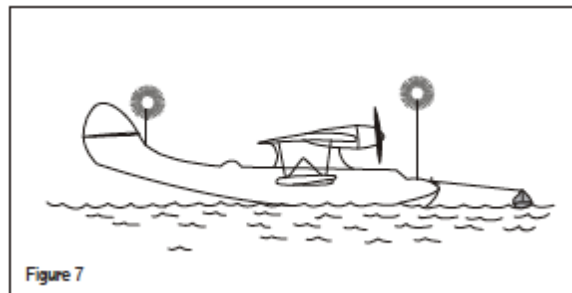
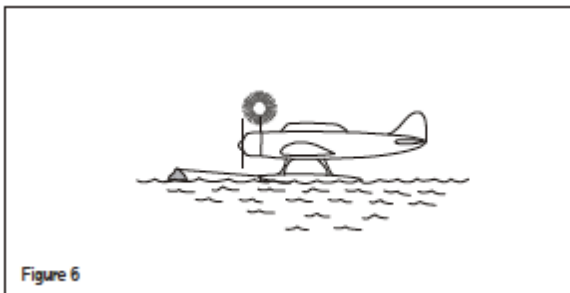

3.8 When aground

- 3.8.1 The lights prescribed in 3.7.1 and in addition two steady red lights in vertical line, at least 1 m apart so placed as to be visible all around the horizon.

16.2 Appendix 2 – Organisation and contents of an Operations Manual

Note. – (Chapter 4, 4.2.3.1, refers)

1 Organisation

- 1.1 An operations manual, which may be issued in separate parts corresponding to specific aspects of operations, provided in accordance with Chapter 4, 4.2.3.1, shall be organised with the following structure:
 - a) Part A General/Basic.
 - b) Part B Aircraft Operating matters.
 - c) Part C Route and Aerodrome Instruction and Information.
 - d) Part D Training.
- 1.2 All operations personnel shall have easy access to the portions of the OM that are relevant to their duties.
- 1.3 The OM shall be kept up to date. All personnel shall be made aware of the changes that are relevant to their duties.
- 1.4 Each crew member shall be provided with a personal copy of the relevant sections of the OM pertaining to their duties. Each holder of an OM, or appropriate parts of it, shall be responsible for keeping their copy up to date with the amendments or revisions supplied by the operator.
- 1.5 When immediate amendments or revisions are required in the interest of safety, they may be published and applied immediately, provided that any approval required has been applied for.
- 1.6 The operator shall incorporate all amendments and revisions required by the CAAM.
- 1.7 The operator shall ensure that information taken from approved documents, and any amendment thereof, is correctly reflected in the OM. This does not prevent the operator from publishing more conservative data and procedures in the OM.
- 1.8 The operator shall ensure that all personnel are able to understand the language in which those parts of the OM which pertain to their duties and responsibilities are written. The content of the OM shall be presented in a form that can be used without difficulty and observes human factors principles.

2 Contents

- 2.1 The OM shall contain the following information, where applicable, as relevant for the area and type of operation. If there are sections that, because of the nature of the operation, do not apply, operators shall maintain the following structure and insert “Not applicable” or “intentionally left blank” where applicable.

A. GENERAL/BASIC

0. ADMINISTRATION AND CONTROL OF OPERATIONS MANUAL

0.1 Introduction:

- a) A statement that the manual complies with all applicable regulations and with the terms and conditions of the applicable AOC.

- b) A statement that the manual contains operational instructions that are to be complied with by the relevant personnel.
 - c) A list and brief description of the various parts, their contents, applicability and use.
 - d) Explanations and definitions of terms and words needed for the use of the manual.
- 0.2 System of amendment and revision:
- a) Details of the person(s) responsible for the issuance and insertion of amendments and revisions.
 - b) A record of amendments and revisions with insertion dates and effective dates.
 - c) A statement that handwritten amendments and revisions are not permitted, except in situations requiring immediate amendment or revision in the interest of safety.
 - d) A description of the system for the annotation of pages or paragraphs and their effective dates.
 - e) A list of effective pages or paragraphs.
 - f) Annotation of changes (in the text and, as far as practicable, on charts and diagrams).
 - g) Temporary revisions.
 - h) A description of the distribution system for the manuals, amendments and revisions.

1. ORGANISATION AND RESPONSIBILITIES

- 1.1. Organisational structure. A description of the organisational structure, including the general organogram and operations departments' organograms. The organogram should depict the relationship between the operations departments and the other departments of the operator. In particular, the subordination and reporting lines of all divisions, departments, etc., which pertain to the safety of flight operations, should be shown.
- 1.2. Nominated persons. The name of each nominated person responsible for flight operations, crew training and ground operations, as prescribed in CAD 6004. A description of their functions and responsibilities should be included.
- 1.3. Responsibilities and duties of operations management personnel. A description of the duties, responsibilities and authority of operations management personnel pertaining to the safety of flight operations and the compliance with the applicable regulations.
- 1.4. Authority, duties and responsibilities of the pilot-in-command. A statement defining the authority, duties and responsibilities of the pilot-in-command.
- 1.5. Duties and responsibilities of crew members other than the pilot-in-command.

2. OPERATIONAL CONTROL AND SUPERVISION

- 2.1. Supervision of the operation by the operator. A description of the system for supervision of the operation by the operator (see 3.1.3.2 of this CAD). This should show how the safety of flight operations and the qualifications of personnel are supervised. In particular, the procedures related to the following items should be described:

- a) licence and qualification validity, competence of operations personnel, control, analysis and storage of the required records.
- 2.2. System and responsibility for promulgation of additional operational instructions and information. A description of any system for promulgating information which may be of an operational nature, but which is supplementary to that in the OM. The applicability of this information and the responsibilities for its promulgation should be included.
 - 2.3. Operational control. A description of the procedures and responsibilities necessary to exercise operational control with respect to flight safety.
 - 2.4. Powers of the authority. A description of the powers of the CAAM and guidance to staff on how to facilitate inspections by CAAM personnel.
3. MANAGEMENT SYSTEM

A description of the management system, including at least the following:

 - a) safety policy;
 - b) the process for identifying safety hazards and for evaluating and managing the associated risks;
 - c) compliance monitoring system;
 - d) allocation of duties and responsibilities;
 - e) documentation of all key management system processes.
 4. CREW COMPOSITION
 - 4.1. Crew composition. An explanation of the method for determining crew compositions, taking account of the following:
 - a) the type of aircraft being used;
 - b) the area and type of operation being undertaken;
 - c) the phase of the flight;
 - d) the minimum crew requirement and flight duty period planned;
 - e) experience (total and on type), recency and qualification of the crew members;
 - f) the designation of the pilot-in-command and, if necessitated by the duration of the flight, the procedures for the relief of the pilot-in-command or other members of the flight crew (see 9.1.2.2 of this CAD);
 - g) the designation of the In-charge cabin crew member and, if necessitated by the duration of the flight, the procedures for the relief of the In-charge cabin crew member and any other member of the cabin crew.
 - 4.2. Designation of the pilot-in-command. The rules applicable to the designation of the pilot-in-command.
 - 4.3. Flight crew incapacitation. Instructions on the succession of command in the event of flight crew incapacitation.
 - 4.4. Operation on more than one type. A statement indicating which aircraft are considered as one type for the purpose of:
 - a) flight crew scheduling; and
 - b) cabin crew scheduling.

5. QUALIFICATION REQUIREMENTS

5.1. A description of the required licence, rating(s), qualification/competency (e.g. for routes and aerodromes), experience, training, checking and recency for operations personnel to conduct their duties. Consideration should be given to the aircraft type, kind of operation and composition of the crew.

5.2. Flight crew:

- a) pilot-in-command,
- b) pilot relieving the pilot-in-command,
- c) co-pilot,
- d) pilot relieving the co-pilot,
- e) pilot under supervision,
- f) system panel operator,
- g) operation on more than one type or variant.

5.3. Cabin crew:

- a) In-charge cabin crew member,
- b) cabin crew member:
 - i) required cabin crew member,
 - ii) additional cabin crew member and cabin crew member during familiarisation flights,

5.4. Training, checking and supervision personnel:

- a) for flight crew; and
- b) for cabin crew.

5.5. Other operations personnel (including technical crew and crew members other than flight, cabin and technical crew).

6. CREW HEALTH PRECAUTIONS

6.1. Crew health precautions. The relevant regulations and guidance to crew members concerning health, including the following:

- a) alcohol and other intoxicating liquids,
- b) narcotics,
- c) drugs,
- d) sleeping tablets,
- e) anti-depressants,
- f) pharmaceutical preparations,
- g) immunisation,
- h) deep-sea diving,
- i) blood/bone marrow donation,
- j) meal precautions prior to and during flight,
- k) sleep and rest,
- l) surgical operations.

7. FLIGHT TIME LIMITATIONS

7.1. Flight and duty time limitations and rest requirements for flight crew and cabin crew, as applicable.

7.2. Exceedance of flight and duty time limitations and/or reductions of rest periods. Conditions under which flight and duty time may be exceeded or rest periods may be reduced, and the procedures used to report these modifications.

8. OPERATING PROCEDURES

8.1. Flight preparation instructions. As applicable to the operation:

8.1.1. Minimum flight altitudes. A description of the method of determination and application of minimum altitudes including:

- a) a procedure to establish the minimum altitudes/flight levels for visual flight rules (VFR) flights; and
- b) a procedure to establish the minimum altitudes/flight levels for instrument flight rules (IFR) flights.

8.1.2. Criteria and responsibilities for determining the adequacy of aerodromes to be used.

8.1.3. Methods and responsibilities for establishing aerodrome operating minima. Reference should be made to procedures for the determination of the visibility and/or runway visual range (RVR) and for the applicability of the actual visibility observed by the pilots, the reported visibility and the reported RVR.

8.1.4. En-route operating minima for VFR flights or VFR portions of a flight and. Where single-engined aircraft are used, instruction for route selection with respect to the availability of surfaces that permit a safe forced landing.

8.1.5. Presentation and application of aerodrome and en-route operating minima

8.1.6. Interpretation of meteorological information. Explanatory material on the decoding of meteorological (MET) forecasts and MET reports relevant to the area of operations, including the interpretation of conditional expressions.

8.1.7. Determination of the quantities of fuel, oil and water methanol carried. The methods by which the quantities of fuel, oil and water methanol to be carried are determined and monitored in-flight. This section should also include instructions on the measurement and distribution of the fluid carried on board. Such instructions should take account of all circumstances likely to be encountered on the flight, including the possibility of in-flight re-planning and of failure of one or more of the aircraft's power plants. The system for maintaining fuel and oil records should also be described.

8.1.8. Mass and centre of gravity. The general principles of mass and centre of gravity including the following:

- a) definitions;
- b) methods, procedures and responsibilities for preparation and acceptance of mass and centre of gravity calculations;
- c) the policy for using standard and/or actual masses;

- d) the method for determining the applicable passenger, baggage and cargo mass;
 - e) the applicable passenger and baggage masses for various types of operations and aircraft type;
 - f) general instructions and information necessary for verification of the various types of mass and balance documentation in use;
 - g) last-minute changes procedures;
 - h) specific gravity of fuel, oil and water methanol;
 - i) seating policy/procedures;
- 8.1.9. Air traffic services (ATS) flight plan. Procedures and responsibilities for the preparation and submission of the ATS flight plan. Factors to be considered include the means of submission for both individual and repetitive flight plans.
- 8.1.10. Operational flight plan. Procedures and responsibilities for the preparation and acceptance of the operational flight plan. The use of the operational flight plan should be described, including samples of the operational flight plan formats in use.
- 8.1.11. Operator's aircraft journey log. The responsibilities and the use of the operator's aircraft journey log should be described, including samples of the format used.
- 8.1.12. List of documents, forms and additional information to be carried.
- 8.2. Ground handling instructions. As applicable to the operation:
- 8.2.1. Fuelling procedures. A description of fuelling procedures, including:
 - a) safety precautions during refuelling and defuelling including when an auxiliary power unit is in operation or when rotors are running or when an engine is or engines are running and the prop-brakes are on;
 - b) refuelling and defuelling when passengers are embarking, on board or disembarking; and
 - c) precautions to be taken to avoid mixing fuels.
 - 8.2.2. Aircraft, passengers and cargo handling procedures related to safety. A description of the handling procedures to be used when allocating seats, embarking and disembarking passengers and when loading and unloading the aircraft. Further procedures, aimed at achieving safety whilst the aircraft is on the ramp, should also be given. Handling procedures should include:
 - a) special categories of passengers, including children/infants, persons with reduced mobility, inadmissible passengers, deportees and persons in custody;
 - b) permissible size and weight of hand baggage;
 - c) loading and securing of items in the aircraft;
 - d) positioning of ground equipment;
 - e) operation of aircraft doors;
 - f) safety on the aerodrome, including fire prevention and safety in blast and suction areas;

- g) start-up, ramp departure and arrival procedures, including push-back and towing operations;
- h) servicing of aircraft;
- i) documents and forms for aircraft handling;
- j) special loads and classification of load compartments; and
- k) multiple occupancy of aircraft seats.

8.2.3. Procedures for the refusal of embarkation. Procedures to ensure that persons who appear to be intoxicated, or who demonstrate by manner or physical indications that they are under the influence of drugs, are refused embarkation. This does not apply to medical patients under proper care.

8.2.4. De-icing and anti-icing on the ground. A description of the de-icing and anti-icing policy and procedures for aircraft on the ground. These should include descriptions of the types and effects of icing and other contaminants on aircraft whilst stationary, during ground movements and during take-off. In addition, a description of the fluid types used should be given, including the following:

- a) proprietary or commercial names,
- b) characteristics,
- c) effects on aircraft performance,
- d) hold-over times,
- e) precautions during usage.

8.3. Flight procedures:

8.3.1. VFR/IFR Policy. A description of the policy for allowing flights to be made under VFR, or for requiring flights to be made under IFR, or for changing from one to the other. Include clarification and acceptance of ATC clearances, particularly where terrain clearance is involved.

8.3.2. Navigation Procedures. A description of all navigation procedures, relevant to the type(s) and area(s) of operation. Special consideration should be given to:

- a) standard navigational procedures, including policy for carrying out independent cross-checks of keyboard entries where these affect the flight path to be followed by the aircraft; and
- b) required navigation performance (RNP), minimum navigation performance specification (NAT HLA (MNPS)) and polar navigation and navigation in other designated areas;
- c) in-flight re-planning;
- d) procedures in the event of system degradation; and
- e) reduced vertical separation minima (RVSM).

8.3.3. Altimeter setting procedures, including, where appropriate, use of:

- a) Metric altimetry and conversion tables; and
- b) QFE operating procedures.

8.3.4. Altitude alerting system procedures

- 8.3.5. warning system (GPWS)/terrain avoidance warning system (TAWS). Procedures and instructions required for the avoidance of controlled flight into terrain, including limitations on high rate of descent near the surface (the related training requirements are covered in OM-D 2.1).
- 8.3.6. Policy, instructions, procedures and training requirements for the use of traffic collision avoidance system (TCAS)/airborne collision avoidance system (ACAS) as per PANS-OPS Doc 8168 Volume III Section 4 Chapter 3.
- 8.3.7. Policy and procedures for in-flight fuel management.
- 8.3.8. Adverse and potentially hazardous atmospheric conditions. Procedures for operating in, and/or avoiding, adverse and potentially hazardous atmospheric conditions, including the following:
- a) thunderstorms,
 - b) icing conditions,
 - c) turbulence,
 - d) windshear,
 - e) jet stream,
 - f) volcanic ash clouds,
 - g) heavy precipitation,
 - h) sand storms,
 - i) mountain waves,
 - j) significant temperature inversions.
- 8.3.9. Wake turbulence. Wake turbulence separation criteria, taking into account aircraft types, wind conditions and runway location.
- 8.3.10. Crew members at their stations. The requirements for crew members to occupy their assigned stations or seats during the different phases of flight or whenever deemed necessary in the interest of safety and, for aeroplane operations, including procedures for controlled rest in the flight crew compartment.
- 8.3.11. Use of restraint devices for crew and passengers. The requirements for crew members and passengers to use safety belts and/or restraint systems during the different phases of flight or whenever deemed necessary in the interest of safety.
- 8.3.12. Admission to flight crew compartment. The conditions for the admission to the flight crew compartment of persons other than the flight crew. The policy regarding the admission of inspectors from an authority should also be included
- 8.3.13. Use of vacant crew seats. The conditions and procedures for the use of vacant crew seats.
- 8.3.14. Incapacitation of crew members. Procedures to be followed in the event of incapacitation of crew members in-flight. Examples of the types of incapacitation and the means for recognising them should be included.
- 8.3.15. Cabin safety requirements. Procedures:

- a) covering cabin preparation for flight, in-flight requirements and preparation for landing, including procedures for securing the cabin and galleys;
- b) to ensure that passengers are seated where, in the event that an emergency evacuation is required, they may best assist and not hinder evacuation from the aircraft;
- c) to be followed during passenger embarkation and disembarkation;
- d) when refuelling/defuelling with passengers embarking, on board or disembarking;
- e) covering the carriage of special categories of passengers;
- f) covering smoking on board;
- g) covering the handling of suspected communicable disease, based on presence of a fever and certain other signs and symptoms, and includes transmission of General Declaration form to CAAM and the Ministry of Health.

8.3.16. Passenger briefing procedures. The contents means and timing of the passenger briefing.

8.3.17. Procedures for aircraft operated whenever required cosmic or solar radiation detection equipment is carried.

8.3.18. Policy on the use of autopilot and auto-throttle for aircraft fitted with these systems.

8.4. Low visibility operations (LVO). A description of the operational procedures associated with LVO.

8.5. Extended Diversion Time Operations (EDTO). A description of the EDTO operational procedures.

8.6. Use of the minimum equipment and configuration deviation list(s).

8.7. Non-commercial operations. Information as required for each type of non-commercial flight performed by the AOC holder. A description of the differences from CAT operations. Procedures and limitations, for example, for the following:

- a) training flights,
- b) flights at the end of lease or upon transfer of ownership,
- c) delivery flights,
- d) ferry flights,
- e) demonstration flights,
- f) positioning flights,
- g) other non-commercial flights.

8.8. Oxygen requirements:

8.8.1. An explanation of the conditions under which oxygen should be provided and used.

8.8.2. The oxygen requirements specified for the following persons:

- a) flight crew;
- b) cabin crew;
- c) passengers.

9. DANGEROUS GOODS AND WEAPONS

9.1. Information, instructions and general guidance on the transport of dangerous goods, including:

- a) operator's policy on the transport of dangerous goods;
- b) guidance on the requirements for acceptance, labelling, handling, stowage and segregation of dangerous goods;
- c) special notification requirements in the event of an accident or occurrence when dangerous goods are being carried;
- d) procedures for responding to emergency situations involving dangerous goods;
- e) duties of all personnel involved; and
- f) instructions on the carriage of the operator's personnel on cargo aircraft when dangerous goods are being carried.

9.2. The conditions under which weapons, munitions of war and sporting weapons may be carried.

10. SECURITY

10.1. Security instructions, guidance, procedures, training and responsibilities. Parts of the security instructions and guidance may be kept confidential.

11. HANDLING, NOTIFYING AND REPORTING ACCIDENTS, INCIDENTS AND OCCURRENCES AND USING THE CVR RECORDING

11.1. Procedures for handling, notifying and reporting accidents, incidents and occurrences. This section should include the following:

- a) definition of accident, incident and occurrence and of the relevant responsibilities of all persons involved;
- b) illustrations of forms to be used for reporting all types of accident, incident and occurrence (or copies of the forms themselves), instructions on how they are to be completed, the addresses to which they should be sent and the time allowed for this to be done;
- c) in the event of an accident, descriptions of which departments, authorities and other organisations have to be notified, how this will be done and in what sequence;
- d) procedures for verbal notification to air traffic service units of incidents involving ACAS resolution advisories (RAs), bird hazards, dangerous goods and hazardous conditions;
- e) procedures for submitting written reports on air traffic incidents, ACAS RAs, bird strikes, dangerous goods incidents or accidents, and unlawful interference;
- f) reporting procedures. These procedures should include internal safety-related reporting procedures to be followed by crew members, designed to ensure that the pilot-in-command is informed immediately of any incident that has endangered, or may have endangered, safety during the flight, and that the pilot-in-command is provided with all relevant information.
- g) Procedures for the preservation of recordings of the flight recorders following an accident or a serious incident or when so directed by the investigating authority.

- h) Procedures for using the CVR recording or its transcripts without prejudice when applicable.

12. RULES OF THE AIR

- a) Visual and instrument flight rules,
- b) Territorial application of the rules of the air,
- c) Communication procedures, including communication-failure procedures,
- d) Information and instructions relating to the interception of civil aircraft,
- e) The circumstances in which a radio listening watch is to be maintained,
- f) Signals,
- g) Time system used in operation,
- h) ATC clearances, adherence to flight plan and position reports,
- i) Visual signals used to warn an unauthorised aircraft flying in or about to enter a restricted, prohibited or danger area,
- j) Procedures for flight crew observing an accident or receiving a distress transmission,
- k) The ground/air visual codes for use by survivors, and description and use of signal aids,
- l) Distress and urgency signals.

13. LEASING/CODE-SHARE

A description of the operational arrangements for leasing and code-share, associated procedures and management responsibilities.

B. AIRCRAFT OPERATING MATTERS – TYPE RELATED

Taking account of the differences between types/classes, and variants of types, under the following headings:

0. GENERAL INFORMATION AND UNITS OF MEASUREMENT

- 0.1 General information (e.g. aircraft dimensions), including a description of the units of measurement used for the operation of the aircraft type concerned and conversion tables.

1 LIMITATIONS

- 1.1 A description of the certified limitations and the applicable operational limitations should include the following:

- a) certification status (e.g. EASA (supplemental) type certificate, environmental certification, etc.);
- b) passenger seating configuration for each aircraft type, including a pictorial presentation;
- c) types of operation that are approved (e.g. VFR/IFR, CAT II/III, RNP, flights in known icing conditions, etc.);
- d) crew composition;
- e) mass and centre of gravity;
- f) speed limitations;
- g) flight envelope(s);
- h) wind limits, including operations on contaminated runways;
- i) performance limitations for applicable configurations;

- j) (runway) slope;
- k) limitations on wet or contaminated runways;
- l) airframe contamination;
- m) system limitations.

2 NORMAL PROCEDURES

The normal procedures and duties assigned to the crew, the appropriate checklists, the system for their use and a statement covering the necessary coordination procedures between flight and cabin/other crew members. The normal procedures and duties should include the following:

- a) pre-flight,
- b) pre-departure, briefing, and loading.
- c) altimeter setting and checking,
- d) taxi, take-off and climb,
- e) noise abatement,
- f) cruise and descent,
- g) approach, landing preparation and briefing,
- h) VFR approach,
- i) IFR approach,
- j) visual approach and circling,
- k) missed approach,
- l) normal landing,
- m) post-landing,
- n) operations on wet and contaminated runways.

3 ABNORMAL AND/OR EMERGENCY PROCEDURES

The abnormal and/or emergency procedures and duties assigned to the crew, the appropriate checklists, the system for their use and a statement covering the necessary coordination procedures between flight and cabin/other crew members. The abnormal and/or emergency procedures and duties should include the following:

- a) crew incapacitation,
- b) fire and smoke drills,
- c) un-pressurised and partially pressurised flight,
- d) exceeding structural limits such as overweight landing,
- e) lightning strikes,
- f) distress communications and alerting ATC to emergencies,
- g) engine/burner failure,
- h) system failures,
- i) guidance for diversion in case of serious technical failure,
- j) ground proximity warnings
- k) ACAS/TCAS warning
- l) windshear,
- m) emergency landing/ditching,
- n) departure contingency procedures.

4 PERFORMANCE

4.0 Performance data should be provided in a form that can be used without difficulty.

4.1 Performance data. Performance material that provides the necessary data for compliance with the performance requirements prescribed in this CAD, and shall be included to allow the determination of the following:

- a) take-off climb limits — mass, altitude, temperature;
- b) take-off field length (for dry, wet and contaminated runway conditions);

- c) net flight path data for obstacle clearance calculation or, where applicable, take-off flight path;
 - d) the gradient losses for banked climb-outs;
 - e) en-route climb limits;
 - f) approach climb limits;
 - g) landing climb limits;
 - h) landing field length (for dry, wet and contaminated runway conditions) including the effects of an in-flight failure of a system or device, if it affects the landing distance;
 - i) brake energy limits;
 - j) speeds applicable for the various flight stages (also considering dry, wet and contaminated runway conditions).
- 4.1.1 Supplementary data covering flights in icing conditions. Any certified performance related to an allowable configuration, or configuration deviation, such as anti-skid inoperative.
- 4.1.2 If performance data, as required for the appropriate performance class, are not available in the , then other data should be included. The OM may contain cross-reference to the data contained in the where such data are not likely to be used often or in an emergency.
- 4.2 Additional performance data, where applicable, including the following:
- a) all engine climb gradients,
 - b) drift-down data,
 - c) effect of de-icing/anti-icing fluids,
 - d) flight with landing gear down,
 - e) or aircraft with 3 or more engines, one-engine-inoperative ferry flights,
 - f) flight conducted under the provisions of the configuration deviation list (CDL).
- 5 FLIGHT PLANNING
- 5.0 Data and instructions necessary for pre-flight and in-flight planning including factors such as speed schedules and power settings. Where applicable, procedures for engine(s)-out operations, (particularly the one-engine-inoperative cruise speed and maximum distance to an adequate aerodrome and flights to isolated aerodromes shall be included.
- 5.1 The method for calculation fuel needed for various stages of flight.
- 5.2 When applicable, performance data for EDTO critical fuel reserve and area of operation, including sufficient data to support the critical fuel reserve and area of operation calculation based on approved aircraft performance data. The following data should be included:
- a) detailed engine(s)-inoperative performance data, including fuel flow for standard and non-standard atmospheric conditions and as a function of airspeed and power setting, where appropriate, covering:
 - i) drift down (includes net performance), where applicable;
 - ii) cruise altitude coverage including 10 000 ft;
 - iii) holding;
 - iv) altitude capability (includes net performance); and
 - v) missed approach;
 - b) detailed all-engine-operating performance data, including nominal fuel flow data, for standard and non-standard atmospheric conditions and as a function of airspeed and power setting, where appropriate, covering:
 - i) cruise (altitude coverage including 10 000 ft); and
 - ii) holding;

- c) details of any other conditions relevant to EDTO operations which can cause significant deterioration of performance, such as ice accumulation on the unprotected surfaces of the aircraft, ram air turbine (RAT) deployment, thrust-reverser deployment, etc.; and
 - d) the altitudes, airspeeds, thrust settings, and fuel flow used in establishing the EDTO area of operations for each airframe-engine combination should be used in showing the corresponding terrain and obstruction clearance.
- 6 **MASS AND BALANCE**
Instructions and data for the calculation of the mass and balance, including the following:
 - a) calculation system (e.g. index system);
 - b) information and instructions for completion of mass and balance documentation, including manual and computer-generated types;
 - c) limiting masses and centre of gravity for the types, variants or individual aircraft used by the operator;
 - d) dry operating mass and corresponding centre of gravity or index.
- 7 **LOADING**
Procedures and provisions for loading and unloading and securing the load in the aircraft.
- 8 **CONFIGURATION DEVIATION LIST**
The CDL(s), if provided by the manufacturer, taking account of the aircraft types and variants operated, including procedures to be followed when an aircraft is being dispatched under the terms of its CDL.
- 9 **MINIMUM EQUIPMENT LIST (MEL)**
The MEL for each aircraft type or variant operated and the type(s)/area(s) of operation. The MEL should also include the dispatch conditions associated with operations required for a specific approval (e.g. RNAV, RNP, RVSM, ETOPS). Consideration should be given to using the ATA number system when allocating chapters and numbers.
- 10 **SURVIVAL AND EMERGENCY EQUIPMENT INCLUDING OXYGEN**
 - 10.1 A list of the survival equipment to be carried for the routes to be flown and the procedures for checking the serviceability of this equipment prior to take-off. Instructions regarding the location, accessibility and use of survival and emergency equipment and its associated checklist(s) shall also be included.
 - 10.2 The procedure for determining the amount of oxygen required and the quantity that is available. The flight profile, number of occupants and possible cabin decompression should be considered.
- 11 **EMERGENCY EVACUATION PROCEDURES**
 - 11.1 Instructions for preparation for emergency evacuation, including crew coordination and emergency station assignment.
 - 11.2 Emergency evacuation procedures. A description of the duties of all members of the crew for the rapid evacuation of an aircraft and the handling of the passengers in the event of a forced landing, ditching or other emergency.
- 12 **AIRCRAFT SYSTEMS**
A description of the aircraft systems, related controls and indications and operating instructions. Consideration should be given to use the ATA number system when allocating chapters and numbers.

Note. – Documents such as Flight Crew Operations Manuals (FCOM) from the manufacturer of the aeroplane may be acceptable to the CAAM to satisfy the requirements of this section of the Operations Manual.

C. ROUTE/AREA AND AERODROME INSTRUCTIONS AND INFORMATION

1. Instructions and information relating to communications, navigation and aerodromes, including minimum flight levels and altitudes for each route to be flown and operating minima for each aerodrome planned to be used, including the following:
 - a) minimum flight level/altitude;
 - b) operating minima for departure, destination and alternate aerodromes;
 - c) communication facilities and navigation aids;
 - d) runway data and aerodrome facilities;
 - e) approach, missed approach and departure procedures including noise abatement procedures;
 - f) communication-failure procedures;
 - g) search and rescue facilities in the area over which the aircraft is to be flown;
 - h) a description of the aeronautical charts that should be carried on board in relation to the type of flight and the route to be flown, including the method to check their validity;
 - i) availability of aeronautical information and MET services;
 - j) en-route communication/navigation procedures;
 - k) aerodrome categorisation for flight crew competence qualification;
 - l) special aerodrome limitations (performance limitations and operating procedures, etc.)

D. TRAINING

1. Description of scope: Training syllabi and checking programmes for all operations personnel assigned to operational duties in connection with the preparation and/or conduct of a flight.
2. Content: Training syllabi and checking programmes for flight crew, cabin crew, technical crew and operations personnel other than crew members (e.g. dispatcher, handling personnel, etc.)
3. Procedures:
 - 3.1 Procedures for training and checking.
 - 3.2 Procedures to be applied in the event that personnel do not achieve or maintain the required standards.
 - 3.3 Procedures to ensure that abnormal emergency situations requiring the application of part or all of the abnormal or emergency procedures, and simulation of instrument meteorological conditions (IMC) by artificial means are not simulated during CAT operations.
4. Description of documentation to be stored and storage periods.



INTENTIONALLY LEFT BLANK

16.3 Appendix 3 – Additional requirements for approved operations by single-engine turbine-powered aeroplanes at night and/or in instrument meteorological conditions (IMC)

Note. – (Chapter 5, 5.4, refers)

Airworthiness and operational requirements provided in accordance with Chapter 5, 5.4.1, shall satisfy the following:

1. TURBINE ENGINE RELIABILITY

1.1. Turbine engine reliability shall be shown to have a power loss rate of less than 1 per 100000 engine hours.

1.2. The operator shall be responsible for engine trend monitoring.

1.3. To minimise the probability of in-flight engine failure, the engine shall be equipped with:

- a) an ignition system that activates automatically, or is capable of being operated manually, for take-off and landing, and during flight, in visible moisture;
- b) a magnetic particle detection or equivalent system that monitors the engine, accessories gearbox, and reduction gearbox, and which includes a flight deck caution indication; and
- c) an emergency engine power control device that permits continuing operation of the engine through a sufficient power range to safely complete the flight in the event of any reasonably probable failure of the fuel control unit.

2. SYSTEMS AND EQUIPMENT

2.1. Single-engine turbine-powered aeroplanes approved to operate at night and/or in IMC shall be equipped with the following systems and equipment intended to ensure continued safe flight and to assist in achieving a safe forced landing after an engine failure, under all allowable operating conditions:

- a) two separate electrical generating systems, each one capable of supplying all probable combinations of continuous in-flight electrical loads for instruments, equipment and systems required at night and/or in IMC;
- b) a radio altimeter;
- c) an emergency electrical supply system of sufficient capacity and endurance, following loss of all generated power, to as a minimum:
 - 1) maintain the operation of all essential flight instruments, communication and navigation systems during a descent from the maximum certificated altitude in a glide configuration to the completion of a landing;
 - 2) lower the flaps and landing gear, if applicable;
 - 3) provide power to one pitot heater, which must serve an air speed indicator clearly visible to the pilot;
 - 4) provide for operation of the landing light specified in 2 j);
 - 5) provide for or one engine restart, if applicable; and
 - 6) provide for the operation of the radio altimeter;
- d) two attitude indicators, powered from independent sources;
- e) a means to provide for at least one attempt at engine re-start;
- f) airborne weather radar;

- g) a certified area navigation system capable of being programmed with the positions of aerodromes and safe forced landing areas, and providing instantly available track and distance information to those locations;
- h) for passenger operations, passenger seats and mounts which meet dynamically-tested performance standards and which are fitted with a shoulder harness or a safety belt with a diagonal shoulder strap for each passenger seat;
- i) in pressurised aeroplanes, sufficient supplemental oxygen for all occupants for descent following engine failure at the maximum glide performance from the maximum certificated altitude to an altitude at which supplemental oxygen is no longer required;
- j) a landing light that is independent of the landing gear and is capable of adequately illuminating the touchdown area in a night forced landing; and
- k) an engine fire warning system.

3. MINIMUM EQUIPMENT LIST

- 3.1. The operator shall specify the operating equipment required for night and/or IMC operations, and for day/VMC operations, in accordance with Chapter 5, 5.4

4. FLIGHT MANUAL INFORMATION

- 4.1. The flight manual shall include limitations, procedures, approval status and other information relevant to operations by single-engine turbine-powered aeroplanes at night and/or in IMC.

5. EVENT REPORTING

- 5.1. The operator approved for operations by single-engine turbine-powered aeroplanes at night and/or in IMC shall report all significant failures, malfunctions or defects to the CAAM who in turn will notify the State of Design.
- 5.2. The CAAM will review the safety data and monitor the reliability information and take any actions necessary to ensure that the intended safety level is achieved. The CAAM will notify major events or trends of particular concern to the appropriate Type Certificate Holder and the State of Design.

6. OPERATOR PLANNING

- 6.1. Operator route planning shall take account of all relevant information in the assessment of intended routes or areas of operations, including the following:
 - a) the nature of the terrain to be overflown, including the potential for carrying out a safe forced landing in the event of an engine failure or major malfunction;
 - b) weather information, including seasonal and other adverse meteorological influences that may affect the flight; and
 - c) other criteria and limitations as specified by the CAAM.

The operator shall identify aerodromes or safe forced landing areas available for use in the event of engine failure, and the position of these shall be programmed into the area navigation system

16.4 Appendix 4 – Altimetry system performance requirements for operations in RVSM airspace

Note. – (Chapter 7, 7.2.7, refers)

1. In respect of groups of aeroplanes that are nominally of identical design and build with respect to all details that could influence the accuracy of height-keeping performance, the height-keeping performance capability shall be such that the total vertical error (TVE) for the group of aeroplanes shall have a mean no greater than 25 m (80 ft) in magnitude and shall have a standard deviation no greater than $28 - 0.013z^2$ for $0 \leq z \leq 25$ when z is the magnitude of the mean TVE in metres, or $92 - 0.004z^2$ for $0 \leq z \leq 80$ where z is in feet. In addition, the components of TVE shall have the following characteristics:
 - a) the mean altimetry system error (ASE) of the group shall not exceed 25 m (80 ft) in magnitude;
 - b) the sum of the absolute value of the mean ASE and of three standard deviations of ASE shall not exceed 75 m (245 ft); and
 - c) the differences between cleared flight level and the indicated pressure altitude actually flown shall be symmetric about a mean of 0 m, with a standard deviation no greater than 13.3 m (43.7 ft), and in addition, the decrease in the frequency of differences with increasing difference magnitude shall be at least exponential.
2. In respect of aeroplanes for which the characteristics of the airframe and altimetry system fit are unique and so cannot be classified as belonging to a group of aeroplanes encompassed by paragraph 1, the height-keeping performance capability shall be such that the components of the TVE of the aeroplane have the following characteristics:
 - a) the ASE of the aeroplane shall not exceed 60 m (200 ft) in magnitude under all flight conditions; and
 - b) the differences between the cleared flight level and the indicated pressure altitude actually flown shall be symmetric about a mean of 0 m, with a standard deviation no greater than 13.3 m (43.7 ft), and in addition, the decrease in the frequency of differences with increasing difference magnitude shall be at least exponential.



INTENTIONALLY LEFT BLANK



16.5 Appendix 5 – Safety Oversight of Air Operators

-RESERVED-



INTENTIONALLY LEFT BLANK

16.6 Appendix 6 – Air Operators Certificate (AOC)

Note. – (Chapter 4, 4.2.1.5 and 4.2.1.6, refer)

1. PURPOSE AND SCOPE

- 1.1. The AOC and its associated model specific operations specifications shall contain the minimum information required in CAD 6004 respectively, in a standardised format.
- 1.2. The air operator certificate and its associated operations specifications shall define the operations for which the operator is authorised.

Note. — Attachment D, paragraph 3.2.2, contains additional information that may be listed in the operations specifications associated with the air operator certificate.

2. AOC TEMPLATE

Note. – Details on the AOC template can be found in Attachment C of the CAGM 6004 – AOC.

3. OPERATIONS SPECIFICATIONS FOR EACH AIRCRAFT MODEL

- 3.1. For each aircraft model in the operator's fleet, identified by aircraft make, model and series, the following list of authorisations, conditions and limitations shall be included: issuing authority contact details, operator name and AOC number, date of issue and signature of the authority representative, aircraft model, types and area of operations, special limitations and authorisations.

Note. — If authorisations and limitations are identical for two or more models, these models may be grouped in a single list.

- 3.2. The operations specifications layout referred to in Chapter 4, 4.2.1.6, can be found in Attachment C of the CAGM 6004 – AOC.

Note. — The MEL constitutes an integral part of the operations manual.



INTENTIONALLY LEFT BLANK



16.7 Appendix 7 – Fatigue Risk Management System Requirements

-RESERVED-



INTENTIONALLY LEFT BLANK

16.8 Appendix 8 – Flight Recorders

Note. – (Chapter 6, 6.3, 6.18 refers)

The material in this Appendix concerns flight recorders intended for installation in aeroplanes engaged in international air navigation. Crash-protected flight recorders comprise one or more of the following systems:

- a flight data recorder (FDR),
- a cockpit voice recorder (CVR),
- an airborne image recorder (AIR),
- a data link recorder (DLR).

Lightweight flight recorders comprise one or more of the following systems:

- an aircraft data recording system (ADRS),
- a cockpit audio recording system (CARS),
- an airborne image recording system (AIRS),
- a data link recording system (DLRS).

1. GENERAL REQUIREMENTS

1.1. Non-deployable flight recorder containers shall be painted a distinctive orange colour.

1.2. Non-deployable crash-protected flight recorder containers shall:

- a) carry reflective material to facilitate their location; and
- b) have securely attached an automatically activated underwater locating device operating at a frequency of 37.5 kHz. At the earliest practicable date, but not later than 1 January 2018, this device shall operate for a minimum of 90 days.

1.3. Automatic deployable flight recorder containers shall:

- a) be painted a distinctive orange colour, however the surface visible from outside the aircraft may be of another colour;
- b) carry reflective material to facilitate their location; and
- c) have an integrated automatically activated ELT.

1.4. The flight recorder systems shall be installed so that:

- a) the probability of damage to the recordings is minimised;
- b) there is an aural or visual means for pre-flight checking that the flight recorder systems are operating properly; and
- c) if the flight recorder systems have an erasure device, the installation shall be designed to prevent operation of the device during flight time or crash impact; and
- d) for aeroplanes for which the individual certificate of airworthiness is first issued on or after 1 January 2023, a flight crew-operated erase function shall be provided on the flight deck which, when activated, modifies the recording of a CVR and AIR so that it cannot be retrieved using normal replay or copying techniques. The installation shall be designed to prevent activation during

flight. In addition, the probability of an inadvertent activation of an erase function during an accident shall also be minimized.

Note.— The erase function is intended to prevent access to CVR and AIR recordings by normal replay or copying means, but would not prevent accident investigation authorities access to such recordings by specialised replay or copying techniques.

- 1.5. The flight recorder systems shall be installed so that they receive electrical power from a bus that provides the maximum reliability for operation of the flight recorder systems without jeopardising service to essential or emergency loads.
 - 1.6. The flight recorder systems, when tested by methods approved by the appropriate certificating authority, shall be demonstrated to be suitable for the environmental extremes over which they are designed to operate.
 - 1.7. Means shall be provided for an accurate time correlation between the flight recorder systems recordings.
 - 1.8. The manufacturer shall provide the appropriate certificating authority with the following information in respect of the flight recorder systems:
 - a) manufacturer's operating instructions, equipment limitations and installation procedures;
 - b) parameter origin or source and equations which relate counts to units of measurement; and
 - c) manufacturer's test reports.
2. FLIGHT DATA RECORDER (FDR) AND AIRCRAFT DATA RECORDING SYSTEMS (ADRS)

2.1. Start and stop logic

The FDR or ADRS shall start to record prior to the aeroplane moving under its own power and record continuously until the termination of the flight when the aeroplane is no longer capable of moving under its own power.

2.2. Parameters to be recorded

2.2.1. The parameters that satisfy the requirements for FDRs are listed in Table A8-1. The number of parameters to be recorded shall depend on aeroplane complexity. The parameters without an asterisk (*) are mandatory parameters which shall be recorded regardless of aeroplane complexity. In addition, the parameters designated by an asterisk (*) shall be recorded if an information data source for the parameter is used by aeroplane systems or the flight crew to operate the aeroplane. However, other parameters may be substituted with due regard to the aeroplane type and the characteristics of the recording equipment.

2.2.2. If further FDR recording capacity is available, recording of the following additional information shall be considered:

- a) operational information from electronic display systems, such as electronic flight instrument systems (EFIS), electronic centralised aircraft monitor (ECAM) and engine indication and crew alerting system (EICAS). Use the following order of priority:

- 1) parameters selected by the flight crew relating to the desired flight path, e.g. barometric pressure setting, selected altitude, selected airspeed, decision height, and autoflight system engagement and mode indications if not recorded from another source;
 - 2) display system selection/status, e.g. SECTOR, PLAN, ROSE, NAV, WXR, COMPOSITE, COPY, ETC.;
 - 3) warnings and alerts; and
 - 4) the identity of displayed pages for emergency procedures and checklists; and
- b) retardation information including brake application for use in the investigation of landing overruns and rejected take-offs.

2.2.3. The parameters that satisfy the requirements for flight path and speed as displayed to the pilot(s) are listed below. The parameters without an (*) are mandatory parameters which shall be recorded. In addition, the parameters designated by an (*) shall be recorded if an information source for the parameter is displayed to the pilot and is practicable to record:

- Pressure altitude
- Indicated airspeed or calibrated airspeed
- Heading (primary flight crew reference)
- Pitch attitude
- Roll attitude
- Engine thrust/power
- Landing-gear status*
- Total or outside air temperature*
- Time*
- Navigation data*: drift angle, wind speed, wind direction, latitude/longitude
- Radio altitude*

2.2.4. The parameters that satisfy the requirements for ADRS are listed in Table A8-3.

2.3. Additional information

2.3.1. The measurement range, recording interval and accuracy of parameters on installed equipment shall be verified by methods approved by the appropriate certificating authority.

2.3.2. Documentation concerning parameter allocation, conversion equations, periodic calibration and other serviceability/maintenance information shall be maintained by the operator. The documentation needs to be sufficient to ensure that accident investigation authorities have the necessary information to read out the data in engineering units.

3. COCKPIT VOICE RECORDER (CVR) AND COCKPIT AUDIO RECORDING SYSTEM (CARS)

3.1. Start and stop logic

The CVR or CARS shall start to record prior to the aeroplane moving under its own power and record continuously until the termination of the flight when the aeroplane is no longer capable of moving under its own power. In addition, depending on the availability of electrical power, the CVR or CARS shall start to record as early as possible during the cockpit checks prior to engine start at the beginning of the flight until the cockpit checks immediately following engine shutdown at the end of the flight.

3.2. Signals to be recorded

3.2.1. The CVR shall record simultaneously on four separate channels, or more, at least the following:

- a) voice communication transmitted from or received in the aeroplane by radio;
- b) aural environment on the flight deck;
- c) voice communication of flight crew members on the flight deck using the aeroplane's interphone system, if installed;
- d) voice or audio signals identifying navigation or approach aids introduced in the headset or speaker; and
- e) voice communication of flight crew members using the passenger address system, if installed.

3.2.2. The preferred CVR audio allocation should be as follows:

- a) pilot-in-command audio panel;
- b) co-pilot audio panel;
- c) additional flight crew positions and time reference; and
- d) cockpit area microphone.

3.2.3. The CARS shall record simultaneously on two separate channels, or more, at least the following:

- a) voice communication transmitted from or received in the aeroplane by radio;
- b) aural environment on the flight deck; and
- c) voice communication of flight crew members on the flight deck using the aeroplane's interphone system, if installed.

3.2.4. The preferred CARS audio allocation should be as follows:

- a) voice communication; and
- b) aural environment on the flight deck.

4. AUTOMATIC DEPLOYABLE FLIGHT RECORDER (ADFR)

4.1. Operation

The following requirements shall apply to an ADFR:

- deployment shall take place when the aeroplane structure has been significantly deformed;
- deployment shall take place when an aeroplane sinks in water;
- ADFR shall not be capable of manual deployment;
- the ADFR shall be able to float on water;
- the ADFR deployment shall not compromise the safe continuation of the flight;
- the ADFR deployment shall not significantly reduce the chance of survival of the recorder and of successful transmission by its ELT;
- the ADFR deployment shall not release more than one piece;
- an alert shall be made to the flight crew when the ADFR is no longer captive to the aircraft;
- the flight crew shall have no means to disable ADFR deployment when the aircraft is airborne;
- the ADFR shall contain an integrated ELT, which shall activate automatically during the deployment sequence.

Such ELT may be of a type that is activated in-flight and provides information from which a position can be determined; and

- the integrated ELT of an ADFR shall satisfy the same requirements as an ELT required to be installed on an aeroplane. The integrated ELT shall at least have the same performance as the fixed ELT to maximise detection of the transmitted signal.

Note 1.— Refer to the Manual on Location of Aircraft in Distress and Flight Recorder Data Recovery (Doc 10054) for more information on ADFR.

Note 2.— If an integrated ELT of a type that is activated in flight is used within an ADFR, it could be a means to comply with the requirements of Chapter 6, 6.18.

5. DATA LINK RECORDER (DLR)

5.1. Applications to be recorded

- 5.1.1. Where the aircraft flight path is authorised or controlled through the use of data link messages, all data link messages, both uplinks (to the aircraft) and downlinks (from the aircraft), shall be recorded on the aircraft. As far as practicable, the time the messages were displayed to the flight crew and the time of the responses shall be recorded.

Note.— Sufficient information to derive the content of the data link communications message and the time the messages were displayed to the flight crew is needed to determine an accurate sequence of events on board the aircraft.

- 5.1.2. Messages applying to the applications listed in Table A8-2 shall be recorded. Applications without the asterisk (*) are mandatory applications which shall be recorded regardless of the system complexity. Applications with an (*) shall be recorded only as far as is practicable given the architecture of the system.

6. FLIGHT CREW-MACHINE INTERFACE RECORDINGS

6.1. Start and stop logic

The AIR or AIRS shall start to record prior to the aeroplane moving under its own power and record continuously until the termination of the flight when the aeroplane is no longer capable of moving under its own power. In addition, depending on the availability of electrical power, the AIR or AIRS shall start to record as early as possible during the cockpit checks prior to engine start at the beginning of the flight until the cockpit checks immediately following engine shutdown at the end of the flight.

6.2. Classes

- 6.2.1. A Class A AIR or AIRS captures the general cockpit area in order to provide data supplemental to conventional flight recorders.

Note 1.— To respect crew privacy, the cockpit area view may be designed as far as practical to exclude the head and shoulders of crew members whilst seated in their normal operating position.

Note 2.— There are no provisions for Class A AIR or AIRS in this document.

- 6.2.2. A Class B AIR or AIRS captures data link message displays.

- 6.2.3. A Class C AIR or AIRS captures instruments and control panels.

Note.— A Class C AIR or AIRS may be considered as a means for recording flight data where it is not practical or is prohibitively expensive to record on an FDR or an ADRS, or where an FDR is not required.

6.3. Applications to be recorded

- 6.3.1. The operation of switches and selectors and the information displayed to the flight crew from electronic displays shall be captured by sensors or other electronic means.

- 6.3.2. The recording of operation of switches and selectors by the flight crew shall include the following:

- any switch or selector that will affect the operation and the navigation of the aircraft; and
- selection of normal and alternate systems.

- 6.3.3. The recording of the information displayed to the flight crew from electronic displays shall include the following:

- primary flight and navigation displays;
- aircraft system monitoring displays;
- engine indication displays;
- traffic, terrain, and weather displays;
- crew alerting systems displays;
- stand-by instruments; and
- installed EFB to the extent it is practical.

- 6.3.4. If image sensors are used, the recording of such images shall not capture the head and shoulders of the flight crew members while seated in their normal operating position.

7. INSPECTIONS OF FLIGHT RECORDER SYSTEMS

- 7.1. Prior to the first flight of the day, the built-in test features for the flight recorders and flight data acquisition unit (FDAU), when installed, shall be monitored by manual and/or automatic checks.
- 7.2. FDR systems or ADRS, CVR systems or CARS, and AIR systems or AIRS shall have recording inspection intervals of one year; subject to the approval from the CAAM, this period may be extended to two years provided these systems have demonstrated a high integrity of serviceability and self-monitoring. DLR systems or DLRS shall have recording inspection intervals of two years; subject to the approval from the CAAM, this period may be extended to four years provided these systems have demonstrated high integrity of serviceability and self-monitoring.
- 7.3. Recording inspections shall be carried out as follows:
 - a) an analysis of the recorded data from the flight recorders shall ensure that the recorder operates correctly for the nominal duration of the recording;
 - b) the analysis of the FDR or ADRS recording shall evaluate the quality of the recorded data to determine if the bit error rate (including those errors introduced by recorder, the acquisition unit, the source of the data on the aeroplane and by the tools used to extract the data from the recorder) is within acceptable limits and to determine the nature and distribution of the errors;
 - c) the FDR or ADRS recording from a complete flight shall be examined in engineering units to evaluate the validity of all recorded parameters. Particular attention shall be given to parameters from sensors dedicated to the FDR or ADRS. Parameters taken from the aircraft's electrical bus system need not be checked if their serviceability can be detected by other aircraft systems;
 - d) the readout facility shall have the necessary software to accurately convert the recorded values to engineering units and to determine the status of discrete signals;
 - e) an examination of the recorded signal on the CVR or CARS shall be carried out by replay of the CVR or CARS recording. While installed in the aircraft, the CVR or CARS shall record test signals from each aircraft source and from relevant external sources to ensure that all required signals meet intelligibility standards;
 - f) where practicable, during the examination, a sample of in-flight recordings of the CVR or CARS shall be examined for evidence that the intelligibility of the signal is acceptable; and
 - g) an examination of the recorded images on the AIR or AIRS shall be carried out by replay of the AIR or AIRS recording. While installed in the aircraft, the AIR or AIRS shall record test images from each aircraft source and from relevant external sources to ensure that all required images meet recording quality standards.
- 7.4. A flight recorder system shall be considered unserviceable if there is a significant period of poor quality data, unintelligible signals, or if one or more of the mandatory parameters is not recorded correctly.
- 7.5. A report of the recording inspection shall be made available on request to the CAAM for monitoring purposes.

7.6. Calibration of the FDR system:

- a) for those parameters which have sensors dedicated only to the FDR and are not checked by other means, recalibration shall be carried out at least every five years or in accordance with the recommendations of the sensor manufacturer to determine any discrepancies in the engineering conversion routines for the mandatory parameters and to ensure that parameters are being recorded within the calibration tolerances; and
- b) when the parameters of altitude and airspeed are provided by sensors that are dedicated to the FDR system, there shall be a recalibration performed as recommended by the sensor manufacturer, or at least every two years.

Table A8-1. Parameter characteristics for flight data recorders

Serial number	Parameter	Applicability	Measurement range	Maximum sampling and recording interval (seconds)	Accuracy limits (sensor input compared to FDR readout)	Recording resolution
1	Time (UTC when available, otherwise relative time count or GNSS time sync)		24 hours	4	±0.125%/h	1 s
2	Pressure-altitude		–300 m (–1 000 ft) to maximum certificated altitude of aircraft +1 500 m (+5 000 ft)	1	±30 m to ±200 m (±100 ft to ±700 ft)	1.5 m (5 ft)
3	Indicated airspeed or calibrated airspeed		95 km/h (50 kt) to max V _{So} (Note 1) V _{So} to 1.2 V _D (Note 2)	1	±5% ±3%	1 kt (0.5 kt recommended)
4	Heading (primary flight crew reference)		360°	1	±2°	0.5°
5	Normal acceleration (Note 8)	Application for type certification is submitted to a Contracting State before 1 January 2016	–3 g to +6 g	0.125	±1% of maximum range excluding datum error of ±5%	0.004 g
		Application for type certification is submitted to a Contracting State on or after 1 January 2016	–3 g to +6 g	0.0625	±1% of maximum range excluding datum error of ±5%	0.004 g
6	Pitch attitude		±75° or usable range whichever is greater	0.25	±2°	0.5°
7	Roll attitude		±180°	0.25	±2°	0.5°
8	Radio transmission keying		On-off (one discrete)	1		

Serial number	Parameter	Applicability	Measurement range	Maximum sampling and recording interval (seconds)	Accuracy limits (sensor input compared to FDR readout)	Recording resolution
9	Power on each engine (Note 3)		Full range	1 (per engine)	±2%	0.2% of full range or the resolution required to operate the aircraft
10*	Trailing edge flap and cockpit control selection		Full range or each discrete position	2	±5% or as pilot's indicator	0.5% of full range or the resolution required to operate the aircraft
11*	Leading edge flap and cockpit control selection		Full range or each discrete position	2	±5% or as pilot's indicator	0.5% of full range or the resolution required to operate the aircraft
12*	Thrust reverser position		Stowed, in transit, and reverse	1 (per engine)		
13*	Ground spoiler/speed brake selection (selection and position)		Full range or each discrete position	1	±2% unless higher accuracy uniquely required	0.2% of full range
14	Outside air temperature		Sensor range	2	±2°C	0.3°C
15*	Autopilot/auto throttle/AFCS mode and engagement status		A suitable combination of discretises	1		
16	Longitudinal acceleration (Note 8)	Application for type certification submitted to a Contracting State before 1 January 2016	±1 g	0.25	±0.015 g excluding a datum error of ±0.05 g	0.004 g
		Application for type certification submitted to a Contracting State on or after 1 January 2016	±1 g	0.0625	±0.015 g excluding a datum error of ±0.05 g	0.004 g
17	Lateral acceleration (Note 8)	Application for type certification submitted to a Contracting State before 1 January 2016	±1 g	0.25	±0.015 g excluding a datum error of ±0.05 g	0.004 g
		Application for type certification submitted to a Contracting State on or after 1 January 2016	±1 g	0.0625	±0.015 g excluding a datum error of ±0.05 g	0.004 g



Serial number	Parameter	Applicability	Measurement range	Maximum sampling and recording interval (seconds)	Accuracy limits (sensor input compared to FDR readout)	Recording resolution
18	Pilot input and/or control surface position-primary controls (pitch, roll, yaw) (Notes 4 and 8)	Application for type certification submitted to a Contracting State before 1 January 2016	Full range	0.25	±2° unless higher accuracy uniquely required	0.2% of full range or as installed
		Application for type certification submitted to a Contracting State on or after 1 January 2016	Full range	0.125	±2° unless higher accuracy uniquely required	0.2% of full range or as installed
19	Pitch trim position		Full range	1	±3% unless higher accuracy uniquely required	0.3% of full range or as installed
20*	Radio altitude		-6 m to 750 m (-20 ft to 2 500 ft)	1	±0.6 m (±2 ft) or ±3% whichever is greater below 150 m (500 ft) and ±5% above 150 m (500 ft)	0.3 m (1 ft) below 150 m (500 ft) 0.3 m (1 ft) + 0.5% of full range above 150 m (500 ft)
21*	Vertical beam deviation (ILS/GNSS/GLS glide path, MLS elevation, IRNAV/IAN vertical deviation)		Signal range	1	±3%	0.3% of full range
22*	Horizontal beam deviation (ILS/GNSS/GLS localizer, MLS azimuth, IRNAV/IAN lateral deviation)		Signal range	1	±3%	0.3% of full range
23	Marker beacon passage		Discrete	1		
24	Master warning		Discrete	1		
25	Each NAV receiver frequency selection (Note 5)		Full range	4	As installed	

Serial number	Parameter	Applicability	Measurement range	Maximum sampling and recording interval (seconds)	Accuracy limits (sensor input compared to FDR readout)	Recording resolution
26*	DME 1 and 2 distance (includes Distance to runway threshold (GLS) and Distance to missed approach point (IRNAV/IAN)) (Notes 5 and 6)		0 – 370 km (0 – 200 NM)	4	As installed	1 852 m (1 NM)
27	Air/ground status		Discrete	1		
28*	GPWS/TAWS/GCAS status (selection of terrain display mode including pop-up display status) and (terrain alerts, both cautions and warnings, and advisories) and (on/off switch position)		Discrete	1		
29*	Angle of attack		Full range	0.5	As installed	0.3 % of full range
30*	Hydraulics, each system (low pressure)		Discrete	2		0.5% of full range
31*	Navigation data (latitude/longitude, ground speed and drift angle) (Note 7)		As installed	1	As installed	
32*	Landing gear and gear selector position		Discrete	4	As installed	
33*	Groundspeed		As installed	1	Data should be obtained from the most accurate system	1 kt
34	Brakes (left and right brake pressure, left and right brake pedal position)		(Maximum metered brake range, discretised or full range)		±5%	2% of full range

Serial number	Parameter	Applicability	Measurement range	Maximum sampling and recording interval (seconds)	Accuracy limits (sensor input compared to FDR readout)	Recording resolution
35*	Additional engine parameters (EPR, N1, indicated vibration level, N2, EGT, fuel flow, fuel cut-off lever position, N3, engine fuel metering valve position)	Engine fuel metering valve position: Application for type certification is submitted to a Contracting State on or after 1 January 2023	As installed	Each engine each second	As installed	2% of full range
36*	TCAS/ACAS (traffic alert and collision avoidance system)		Discretes	1	As installed	
37*	Wind shear warning		Discrete	1	As installed	
38*	Selected barometric setting (pilot, co-pilot)		As installed	64	As installed	0.1 mb (0.01 in-Hg)
39*	Selected altitude (all pilot selectable modes of operation)		As installed	1	As installed	Sufficient to determine crew selection
40*	Selected speed (all pilot selectable modes of operation)		As installed	1	As installed	Sufficient to determine crew selection
41*	Selected Mach (all pilot selectable modes of operation)		As installed	1	As installed	Sufficient to determine crew selection
42*	Selected vertical speed (all pilot selectable modes of operation)		As installed	1	As installed	Sufficient to determine crew selection
43*	Selected heading (all pilot selectable modes of operation)		As installed	1	As installed	Sufficient to determine crew selection
44*	Selected flight path (all pilot selectable modes of operation) (course/DSTRK, path angle, final approach path (IRNAV/IAN))			1	As installed	
45*	Selected decision height		As installed	64	As installed	Sufficient to determine crew selection
46*	EFIS display format (pilot, co-pilot)		Discrete(s)	4	As installed	
47*	Multi-function/engine/alerts display format		Discrete(s)	4	As installed	
48*	AC electrical bus status		Discrete(s)	4	As installed	

Serial number	Parameter	Applicability	Measurement range	Maximum sampling and recording interval (seconds)	Accuracy limits (sensor input compared to FDR readout)	Recording resolution
49*	DC electrical bus status		Discrete(s)	4	As installed	
50*	Engine bleed valve position		Discrete(s)	4	As installed	
51*	APU bleed valve position		Discrete(s)	4	As installed	
52*	Computer failure		Discrete(s)	4	As installed	
53*	Engine thrust command		As installed	2	As installed	
54*	Engine thrust target		As installed	4	As installed	2% of full range
55*	Computed centre of gravity		As installed	64	As installed	1% of full range
56*	Fuel quantity in CG trim tank		As installed	64	As installed	1% of full range
57*	Head up display in use		As installed	4	As installed	
58*	Para visual display on/off		As installed	1	As installed	
59*	Operational stall protection, stick shaker and pusher activation		As installed	1	As installed	
60*	Primary navigation system reference (GNSS, INS, VOR/DME, MLS, Loran C, localizer glideslope)		As installed	4	As installed	
61*	Ice detection		As installed	4	As installed	
62*	Engine warning each engine vibration		As installed	1	As installed	
63*	Engine warning each engine over temperature		As installed	1	As installed	
64*	Engine warning each engine oil pressure low		As installed	1	As installed	
65*	Engine warning each engine over speed		As installed	1	As installed	
66*	Yaw trim surface position		Full range	2	±3% unless higher accuracy uniquely required	0.3% of full range



Serial number	Parameter	Applicability	Measurement range	Maximum sampling and recording interval (seconds)	Accuracy limits (sensor input compared to FDR readout)	Recording resolution
67*	Roll trim surface position		Full range	2	±3% unless higher accuracy uniquely required	0.3% of full range
68*	Yaw or sideslip angle		Full range	1	±5%	0.5°
69*	De-icing and/or anti-icing systems selection		Discrete(s)	4		
70*	Hydraulic pressure (each system)		Full range	2	±5%	100 psi
71*	Loss of cabin pressure		Discrete	1		
72*	Cockpit trim control input position, Pitch		Full range	1	±5%	0.2% of full range or as installed
73*	Cockpit trim control input position, Roll		Full range	1	±5%	0.2% of full range or as installed
74*	Cockpit trim control input position, Yaw		Full range	1	±5%	0.2% of full range or as installed
75*	All cockpit flight control input forces (control wheel, control column, rudder pedal)		Full range (±311 N (±70 lbf), ± 378 N (±85 lbf), ± 734 N (±165 lbf))	1	±5%	0.2% of full range or as installed
76*	Event marker		Discrete	1		
77*	Date		365 days	64		
78*	ANP or EPE or EPU		As installed	4	As installed	
79*	Cabin pressure altitude	Application for type certification submitted to a Contracting State on or after 1 January 2023	As installed (0 ft to 40 000 ft recommended)	1	As installed	100 ft
80*	Aeroplane computed weight	Application for type certification submitted to a Contracting State on or after 1 January 2023	As installed	64	As installed	1% of full range
81*	Flight director command	Application for type certification submitted to a Contracting State on or after 1 January 2023	Full range	1	± 2°	0.5°
82*	Vertical speed	Application for type certification submitted to a Contracting State on or after 1 January 2023	As installed	0.25	As installed (32 ft/min recommended)	16 ft/min

Notes.—

1. V_{So} stalling speed or minimum steady flight speed in the landing configuration is in Section “Abbreviations and Symbols”.
2. VD design diving speed.
3. Record sufficient inputs to determine power.
4. For aeroplanes with control systems in which movement of a control surface will back drive the pilot’s control, “or” applies. For aeroplanes with control systems in which movement of a control surface will not back drive the pilot’s control, “and” applies. In aeroplanes with split surfaces, a suitable combination of inputs is acceptable in lieu of recording each surface separately. In aeroplanes with independent pilot input on primary controls, each pilot input on primary controls needs to be recorded separately.
5. If signal available in digital form.
6. Recording of latitude and longitude from INS or other navigation system is a preferred alternative.
7. If signals readily available.
8. It is not intended that aeroplanes issued with an individual certificate of airworthiness before 1 January 2016 be modified to meet the measurement range, maximum sampling and recording interval, accuracy limits or recording resolution description detailed in this Appendix.



INTENTIONALLY LEFT BLANK

16.9 Appendix 9 – Location of an aeroplane in distress

Note. – (Chapter 6, 6.18, refers)

1. PURPOSE AND SCOPE

- 1.1. Location of an aeroplane in distress aims at establishing, to a reasonable extent, the location of an accident site within a 6 NM radius.

2. OPERATION

- 2.1. An aeroplane in distress shall automatically activate the transmission of information from which its position can be determined by the operator and the position information shall contain a time stamp. It shall also be possible for this transmission to be activated manually. The system used for the autonomous transmission of position information shall be capable of transmitting that information in the event of aircraft electrical power loss, at least for the expected duration of the entire flight.

Note.— Guidance on the location of an aeroplane in distress is provided in Attachment K of this CAD.

- 2.2. An aircraft is in a distress condition when it is in a state that, if the aircraft behaviour event is left uncorrected, can result in an accident. Autonomous transmission of position information shall be active when an aircraft is in a distress condition. This will provide a high probability of locating an accident site to within a 6 NM radius. The operator shall be alerted when an aircraft is in a distress condition with an acceptable low rate of false alerts. In case of a triggered transmission system, initial transmission of position information shall commence immediately or no later than five seconds after the detection of the activation event.

Note.— Aircraft behaviour events can include, but are not limited to, unusual attitudes, unusual speed conditions, collision with terrain and total loss of thrust/propulsion on all engines and ground proximity warnings.

- 2.3. When an aircraft operator or an air traffic service unit (ATSU) has reason to believe that an aircraft is in distress, coordination shall be established between the ATSU and the aircraft operator.
- 2.4. The minimum organisations that require the position information of an aircraft in an emergency phase are:
 - a) air traffic service unit(s) (ATSU); and
 - b) SAR rescue coordination centre(s) (RCC) and sub-centres.
- 2.5. When autonomous transmission of position information has been activated, it shall only be able to be deactivated using the same mechanism that activated it.
- 2.6. The accuracy of position information shall, as a minimum, meet the position accuracy requirements established for ELTs.



INTENTIONALLY LEFT BLANK

16.10 Appendix 10 – Aeroplane Performance Classes**1 Aeroplane Performance Class A****1.1 Take-off mass**

- a) The take-off mass does not exceed the maximum take-off mass specified in the aeroplane flight manual for the altitude of the aerodrome and for the ambient temperature existing at the time of the take-off.
- b) The maximum take-off mass is calculated, assuming that the critical engine fails at V_{REF} , using a single value of $V1$, to ensure that:
 - 1) the accelerate-stop distance required does not exceed the accelerate-stop distance available;
 - 2) the take-off distance required does not exceed the take-off distance available;
 - 3) any clearway forming part of the take-off distance available shall not exceed half the length of the take-off run available;
 - 4) the take-off run required does not exceed the take-off run available using $V1$ for the rejected and continued take-off;
 - 5) on a wet or contaminated runway, the take-off mass does not exceed that permitted for a take-off on a dry runway under the same conditions; and
 - 6) in the case of a wet or contaminated runway, the take-off distance is calculated to the point at which the aircraft reaches a height of at least 15 feet above the take-off surface using a reduced $V1$.
- c) The maximum take-off mass takes account of:
 - 1) aerodrome elevation;
 - 2) the pressure altitude of the aerodrome when the atmospheric pressure varies by more than 1% from the International Standard Atmosphere;
 - 3) ambient temperature at the aerodrome;
 - 4) the type of runway surface and the runway surface condition;
 - 5) the runway gradient in the direction of take-off; and
 - 6) not more than 50% of the reported head-wind component or not less than 150% of the reported tail-wind component.

1.2 Take-off flight path

- a) With the critical engine inoperative, all obstacles within the net take-off flight path are cleared by at least a vertical margin of at least 35 ft, or by a horizontal distance of $90\text{m} + (0.125 \times D)$, where D is the distance:

- 1) the aeroplane has travelled from the end of the take-off distance available;
or
 - 2) the end of the take-off distance if a turn is scheduled before the end of the take-off distance available; or
 - 3) in the case of aeroplanes with a wingspan of less than 60m, a horizontal distance of half the aeroplane wingspan + (0.125 x D).
- b) When calculating the net take-off flight path:
- 1) the following factors are taken into account:
 - i) take-off mass at the commencement of the take-off run; and
 - ii) aerodrome elevation; and
 - iii) pressure altitude at the aerodrome when the atmospheric pressure varies by more than 1% from the International Standard Atmosphere; and
 - iv) ambient temperature at the aerodrome; and
 - v) not more than 50% of the reported head-wind component or not less than 150% of the reported tail-wind component; and
 - 2) a track change exceeding 15° is not made before a height of 50 feet above the take-off surface has been achieved; and
 - 3) unless otherwise authorised by the CAAM:
 - i) the bank angle up to and including a height of 400 feet above the take-off surface does not exceed 15°; and
 - ii) the bank angle above a height of 400 feet above the take-off surface does not exceed 25°; and
 - 4) allowance is made for:
 - i) the effect of the bank angle on operating speeds and flight path; and
 - ii) distance increments resulting from increased operating speeds; and
 - iii) retention of stall margin and loss of climb gradient.
- c) Obstacles must be considered, except in the following circumstances:
- 1) Where the intended flight path does not require track changes of more than 15°, and the lateral distance of the obstacle is –
 - i) 300 m, in the case of flight is conducted under conditions allowing visual course guidance navigation, or if navigation aids are available enabling the pilot to maintain the intended flight path with the same accuracy; or
 - ii) greater than 600 m in the case of flights under all other conditions.
 - 2) Where the intended flight path does require track changes of more than 15°, and the lateral distance of the obstacle is greater than:
 - i) 600 m, in the case of a flight conducted under conditions allowing visual course guidance navigation;

- ii) 900 m in the case of flights under all other conditions.

1.3 En-route – One engine inoperative

- a) In the meteorological conditions expected for the flight and using the one engine inoperative en-route net flight path data:
 - 1) the flight path has a positive gradient at 1,500 feet above the aerodrome where the landing is assumed to be made after engine failure, taking account of any ice protection system if meteorological conditions require their operation; and
 - 2) the net flight path clears all terrain and obstructions within 10 NM either side of the intended track, by at least 1,000 feet vertically and with a positive gradient; or
 - 3) the net flight path permits the aeroplane to continue flight from the cruising altitude to an aerodrome where a landing can be safely made, clearing vertically by at least 2,000 feet all obstacles within 10 NM either side of the intended track, and taking account of:
 - i) engine failure at the most critical point along the route; and
 - ii) the effect of the icing protection systems if the meteorological conditions require their operation; and
 - iii) the forecast ambient temperature; and
 - iv) the effects of forecast wind on the flight path; and
 - v) fuel jettisoning to an extent consistent with reaching the aerodrome with the required fuel reserves; and
- b) The aerodrome where the aeroplane is assumed to land after engine failure meets the following criteria:
 - 1) the performance requirements at the expected landing mass are met; and
 - 2) weather reports and forecasts, and aerodrome condition reports, indicate that a safe landing can be made at the time of the intended landing.
- c) Track clearance to 5 NM either side of track may be used if navigational accuracy reaches at least 95% containment level.

1.4 En-route – aeroplanes with three or more engines, two engines inoperative

- a) Subject to sub-paragraph (b), each aeroplane with three or more engines is not more than 90 minutes away (at the all engines long-range cruising speed at standard temperature and in still air) from an aerodrome at which a safe landing can be made.
- b) An aircraft with three or more engines may be operated at more than 90 minutes away from an aerodrome at which a safe landing can be made, provided that:

- 1) the two-engine inoperative en-route flight path data permits the aeroplane to continue the flight, in the expected meteorological conditions, from the point where two engines are assumed to fail simultaneously, to an aerodrome at which it is possible to land using the prescribed procedure for a landing with two engines inoperative;
 - 2) the net flight path, taking into account the effect of any ice protection systems if the meteorological conditions require their operation must clear vertically by an altitude of at least 2,000 feet all terrain and obstructions within 10 NM of the intended track to be flown;
 - 3) the net flight path has a positive gradient at an altitude of 1,500 feet above the aerodrome where the landing is assumed to be made after the failure of two engines;
 - 4) fuel jettisoning is permitted to an extent consistent with reaching the aerodrome with the required reserves;
 - 5) the expected mass of the aeroplane at the point where the two engines are assumed to fail shall be not less than that which would include sufficient fuel to proceed to an aerodrome where the landing is assumed to be made, and to arrive there at an altitude of at least 1 500 feet directly over the aerodrome and after that to fly level for at least 15 minutes; and
 - 6) assuming that the two engines fail at the most critical point of that portion of the route where the aeroplane is more than 90 minutes (at the all-engines long-range cruising speed at standard temperature and still air) away from aerodrome at which a safe landing can be made.
- c) Track clearance to 5 NM either side of track may be used if navigational accuracy reaches at least 95% containment level.

1.5 Landing – destination and alternate aerodromes

- a) The landing mass of the aeroplane does not exceed the maximum landing mass, taking into account the altitude and the ambient temperature expected for the estimated time of landing at the destination and alternate aerodrome; and
- b) For instrument approaches with decision heights below 200 feet, the approach mass of the aeroplane, taking into account the take-off mass and the fuel expected to be consumed in flight, allows a missed approach net climb gradient, assuming that the critical engine is inoperative in the approach configuration, of:
 - 1) at least 2.5%; or
 - 2) at least the net climb gradient required to clear any obstacles in the missed approach flight path in accordance with paragraph 1.2 (b)(3) and (4).

1.6 Landing – dry runways

- a) The landing mass for the estimated time of landing does not exceed the landing mass specified in the aeroplane flight manual.
- b) The landing mass for the estimated time of landing at the destination aerodrome and at any alternate aerodrome allows a full stop landing on a dry runway from a point 50 feet above the threshold within:
 - 1) 60% of the landing distance available at the destination and at any alternate aerodrome for a turbojet powered aeroplane; and
 - 2) 70% of the landing distance available at the destination aerodrome and at any alternate aerodrome for a turbo-propeller powered aeroplane; and
- c) The landing mass takes account of
 - 1) the altitude of the aerodrome; and
 - 2) the type of runway surface and the runway surface condition; and
 - 3) the runway gradient in the direction of landing; and
 - 4) not more than 50% of the reported head-wind component or not less than 150% of the reported tail-wind component.
- d) It is assumed that the aeroplane will land on:
 - 1) the most favourable runway in still air; and
 - 2) the aeroplane will land on the runway most likely to be assigned considering the probable wind speed and direction and the ground handling characteristics of the aeroplane, and also considering other conditions such as landing aids and terrain.
- e) If unable to comply with (d)(1) and (2) for the destination aerodrome, the aeroplane may be dispatched if an alternate aerodrome is designated that permits compliance, except when operating to a destination with a single runway requiring a favourable wind component, two suitable alternate aerodromes shall be designated.

1.7 Landing – wet and contaminated runways

- a) When the appropriate weather reports or forecasts, or a combination thereof, indicate that the runway at the estimated time of arrival may be wet, the landing distance available is at least 115% of the landing distance required by paragraph 1.6; and
- b) When the appropriate weather reports or forecasts, or a combination thereof, indicate that the runway at the estimated time of arrival may be contaminated, the landing distance available is at least:
 - 1) 115% of the landing distance required by paragraph 1.6; or

- 2) 115% of the landing distance determined in accordance with the approved contaminated landing distance data, whichever is greater.
- c) a landing distance on a wet runway shorter than that required by sub-paragraph (a), but not less than that required by paragraph 1.6, may be used if performance data in flight manual includes specific additional information which would allow a shorter landing distance on wet runways.

2 Aeroplane Performance Class B

2.1 Take-off mass

- a) The take-off mass does not exceed the maximum take-off mass specified in the aeroplane flight manual for the altitude of the aerodrome and for the ambient temperature existing at the time of the take-off.

2.2 Take-off distance

- a) The unfactored take-off distance as specified in the aeroplane flight manual does not exceed, when multiplied by a factor of 1.25, the take-off run available; or
- b) When a stopway and/or clearway is available, the unfactored take-off distance does not exceed:
 - 1) the take-off run available; and
 - 2) when multiplied by a factor of 1.15, the take-off distance available; and
 - 3) when multiplied by a factor of 1.3, the accelerate-stop distance available
- c) Account is taken of the following
 - 1) the mass of the aeroplane at the commencement of the take-off run;
 - 2) the pressure altitude at the aerodrome; and
 - 3) the ambient temperature at the aerodrome; and
 - 4) the runway surface condition and the type of runway surface; and
 - 5) the runway gradient in the direction of take-off; and
 - 6) not more than 50% of the reported head-wind component, or not less than 150% of the reported tail-wind component.
- d) For seaplane operations account is taken of the following:
 - 1) the wind component normal to the direction of take-off;
 - 2) the water state and density
 - 3) the water surface condition; and
 - 4) the strength of the current.

2.3 Take-off and landing climb

- a) Twin engine aeroplanes which do not meet the following climb requirements are treated as a single engine aeroplane.
- b) Take-off climb, all engines operating:
 - 1) The steady gradient of climb after take-off shall be at least 4% with:
 - i) take-off power selected on each engine;
 - ii) the landing gear extended, except that if the landing gear can be retracted in not more than 7 seconds, it may be assumed to be retracted
 - iii) the wing flaps in the take-off position;
 - iv) a climb speed not less than the greater of 1.1VMC and 1.2VSI.
- c) Take-off climb, one engine inoperative:
 - 1) The steady gradient of climb at an altitude of 400 feet above the take-off surface shall be measurably positive with:
 - i) the critical engine inoperative and its propeller in the minimum drag position; and
 - ii) the remaining engine at take-off power; and
 - iii) the landing gear retracted; and
 - iv) the wing flaps in the take-off position; and
 - v) a climb speed equal to that achieved at 50 ft.
 - 2) The steady gradient of climb shall be not less than 0.75% at an altitude of 1 500 feet above the take-off surface with:
 - i) the critical engine inoperative and its propeller in the minimum drag position; and
 - ii) the remaining engine at not more than maximum continuous power; and
 - iii) the landing gear retracted; and
 - iv) the wing flaps retracted; and
 - v) a climb speed not less than 1.2VSI.
- d) Landing climb, all engines operating:
 - 1) The steady gradient of climb shall be at least 2.5% with:
 - i) not more than the power of thrust that is available 8 seconds after initiation of movement of the power controls from the minimum flight idle position; and
 - ii) the landing gear extended; and
 - iii) the wing flaps in the landing position; and
 - iv) a climb speed equal to V_{REF} .
- e) Landing climb, one engine inoperative:
 - 1) The steady gradient of climb shall be not less than 0.75% at an altitude of 1 500 feet above the landing surface with:

- i) the critical engine inoperative and its propeller in the minimum drag position; and
 - ii) the remaining engine at not more than maximum continuous power; and
 - iii) the landing gear retracted; and
 - iv) the wing flaps retracted; and
 - v) a climb speed not less than $1.2V_{SI}$
- f) Landing gear requirements shall be applied equally to floats and skis where appropriate.

2.4 Take-off flight path – multi-engine aeroplanes

- a) The take-off flight path of aeroplanes with two or more engines, determined in accordance with this paragraph, clears all obstacles by a vertical margin of at least 50 ft, or by a horizontal distance of at least 90 m plus $0,125 \times D$, where D is the horizontal distance travelled by the aeroplane from the end of the take-off distance available or the end of the take-off distance if a turn is scheduled before the end of the take-off distance available.
- b) When showing compliance with sub-paragraph (a) above, account is taken of the following:
- 1) the take-off flight path begins at a height of 50 feet above the surface at the end of the take-off distance required, and ends at a height of 1 500 feet above the surface;
 - 2) the aeroplane is not banked before the aeroplane reaches a height of 50 feet above the surface, and that thereafter the angle of bank does not exceed 15° ;
 - 3) failure of the critical engine occurs at the point on the all engine take-off flight path where visual reference for the purposes of avoiding obstacles is lost;
 - 4) the gradient of the take-off flight path from 50 feet to the assumed engine failure height is equal to the average all engines operating gradient during climb and transition to the en-route configuration multiplied by a factor of 0.77; and
 - 5) the gradient of the take-off flight path from the height reached in accordance with sub-paragraph (b)(4) to the end of the take-off flight path is equal to the one engine inoperative en-route climb gradient shown in the aeroplane flight manual.
- c) Obstacles do not have to be considered where –
- 1) the intended flight path does not require track changes of more than 15° , and the obstacle has a lateral distance greater than:
 - i) 300 m, if the flight is conducted under conditions allowing visual course guidance navigation, or if navigation aids are available enabling the pilot to maintain the intended flight path with the same accuracy; and

- ii) 600 m for flights under all other conditions.
- 2) the intended flight path does require track changes of more than 15°, and the obstacle has a lateral distance greater than:
 - i) 600 m, if the flight is conducted under conditions allowing visual course guidance navigation; or
 - ii) 900 m for flights under all other conditions.
- d) when showing compliance with sub-paragraphs (a), (b) and (c), account is taken of the following:
 - 1) the mass of the aeroplane at the commencement of the take-off run; and
 - 2) the pressure altitude at the aerodrome; and
 - 3) the ambient temperature at the aerodrome; and
 - 4) not more than 50% of the reported head-wind component, or not less than 150% of the reported tail-wind component.

2.5 En-route – multi-engine aeroplanes

- a) An aeroplane is to be capable of continuing flight at or above the relevant minimum altitudes for safe flight to a point 1,000 feet above an aerodrome at which the performance requirements can be met, in the event of failure of one engine, with the remaining engines operating within the maximum continuous power, in the meteorological conditions expected for the flight conditions specified, the aeroplane is capable.
- b) When showing compliance with sub-paragraph (a) above:
 - 1) it shall not be assumed that the aeroplane will be flying at an altitude exceeding that at which the rate of climb equals 300 feet per minute with all engines operating within the specified maximum continuous power conditions specified; and
 - 2) the assumed en-route gradient with one engine inoperative shall be the gross gradient of descent or climb, as appropriate, respectively increased by a gradient of 0.5%, or decreased by a gradient of 0.5%.

2.6 En-route – single-engine aeroplanes

- a) An aeroplane is to be capable of reaching a point from which a safe forced landing can be made, in the event of failure of the engine, in the meteorological conditions expected for the flight.,
- b) In the case of a landplane, a safe forced landing must be a place on land, unless the CAAM otherwise authorises.
- c) When showing compliance with sub-paragraph (a) above:

- 1) it shall not be assumed that the aeroplane will be flying, with the engine operating within the specified maximum continuous power conditions, at an altitude exceeding that at which the rate of climb equals 300 feet per minute; and
- 2) the assumed en-route gradient shall be the gross gradient of descent increased by a gradient of 0.5%.

2.7 Landing – destination and alternate aerodromes

- a) The landing mass of the aeroplane does not exceed the maximum landing mass specified in the aeroplane flight manual for the altitude and ambient temperature expected for the estimated time of landing at the destination and alternate aerodrome.

2.8 Landing – dry runways

- a) The landing mass of the aeroplane for the estimated time of landing at the destination aerodrome and at any alternate aerodrome allows a full stop landing from 50 ft above the threshold within 70% of the landing distance available.
- b) The CAAM may approve the use of factored landing distance data based on a screen height of less than 50 ft, but not less than 35 ft.
- c) When showing compliance with sub-paragraph (a) above, account is taken of the following:
 - 1) the altitude of the aerodrome;
 - 2) the runway surface condition and the type of runway surface;
 - 3) the runway gradient in the direction of landing; and
 - 4) not more than 50% of the reported head-wind component, or not less than 150% of the reported tail-wind component.
- d) When showing compliance with sub-paragraph (a) above, the following conditions will be assumed to exist:
 - 1) the aeroplane will land on the most favourable runway, in still air; and
 - 2) the aeroplane will land on the runway most likely to be assigned considering the probable wind speed and direction and the ground handling characteristics of the aeroplane, and also considering other conditions such as landing aids and terrain.
- e) If an operator is unable to comply with sub-paragraph (d)(2) for the destination aerodrome, the aeroplane may be despatched if an alternate aerodrome is designated which permits full compliance with sub-paragraphs (a), (c) and (d) above.

2.9 Landing – wet and contaminated runways

- a) When the appropriate weather reports or forecasts, or both, indicate that the runway at the estimated time of arrival may be wet, the landing distance available is at least 115% of the landing distance required by paragraph 2.8.
- b) When the appropriate weather reports or forecasts, or both, indicate that the runway at the estimated time of arrival may be contaminated, the landing distance, determined in accordance with data acceptable to the CAAM for those conditions, does not exceed the landing distance available.

3 Aeroplanes Performance Class C

3.1 Take-off Mass

- a) The take-off mass does not exceed the maximum take-off mass specified in the aeroplane flight manual for the altitude of the aerodrome and for the ambient temperature existing at the time of the take-off.

3.2 Take Off distance

- a) Aeroplanes that have take-off field length data in the aeroplane flight manual which does not allow for engine failure, the distance from the start of the take-off roll required by the aeroplane to reach a height of 50 ft above the surface with all engines operating does not exceed the take-off run available at the departure aerodrome, when multiplied by the following factors:
 - 1) 1.33 for two-engine aeroplanes; or
 - 2) 1.25 for three-engine aeroplanes; or
 - 3) 1.18 for four-engine aeroplanes.
- b) Where field length data which allows for engine failure is available:
 - 1) the accelerate-stop distance must not exceed the accelerate-stop distance available; and
 - 2) the take-off distance must not exceed the take-off distance available, with a clearway not exceeding half the take-off run available; and
 - 3) the take-off run must not exceed the take-off run available; and
 - 4) these parameters must be met using a single value of V1 for the rejected and continued take-off; and
 - 5) on a wet or contaminated runway the take-off mass must not exceed the permitted take-off on a dry runway under the same conditions.
- c) When complying with sub-paragraphs (a) or (b) above, account is taken of the following:
 - 1) the pressure altitude at the aerodrome; and
 - 2) the ambient temperature at the aerodrome; and

- 3) the runway surface condition and the type of runway surface; and
- 4) the runway gradient in the direction of take-off; and
- 5) not more than 50% of the reported head-wind component, or not less than 150% of the reported tail-wind component.

3.3 Take off Obstacle Clearance

- a) The take-off flight path with one engine inoperative clears all obstacles by a vertical margin:
 - 1) of at least 50 feet plus $0.01 \times D$; or
 - 2) by a horizontal distance of at least $90 \text{ m} + (0.125 \times D)$; or
 - 3) in the case of aeroplanes with a wingspan of less than 60m, a horizontal distance of half the aeroplane wingspan + $(0.125 \times D)$;

where D is the horizontal distance the aeroplane has travelled from the end of the take-off distance available.
- b) The take-off flight path begins at a height of 50 feet above the surface at the end of the take-off distance required by paragraph 3.2(a) or (b), and end at a height of 1500 feet above the surface; and
- c) When showing compliance with sub-paragraph (a), account shall be taken of the following:
 - 1) the mass of the aeroplane at the commencement of the take-off run; and
 - 2) the pressure altitude at the aerodrome; and
 - 3) the ambient temperature at the aerodrome; and
 - 4) not more than 50% of the reported head-wind component, or not less than 150% of the reported tail-wind component.
- d) Track changes are not allowed up to the point in the take-off path where a height of 50 feet above the surface has been achieved.
- e) After a height of 50 feet above the surface has been achieved and up to a height of 400 feet, the aeroplane should not be banked more than 15° .
- f) Bank angles greater than 25° should not be planned above 400 feet.
- g) In a case where the intended flight path does not require track changes of more than 15° , obstacles do not have to be considered if they have a lateral distance greater than:
 - 1) 300 m, if the flight is conducted under conditions allowing visual course guidance navigation, or if navigation aids are available enabling the pilot to maintain the intended flight path with the same accuracy; and
 - 2) 600 m for flights under all other conditions.

- h) In a case where the intended flight path does require track changes of more than 15°, obstacles do not have to be considered if they have a lateral distance greater than:
 - 1) 600 m, if the flight is conducted under conditions allowing visual course guidance navigation; or
 - 2) 900 m for flights under all other conditions.

3.4 En-route – all engines operating

In the meteorological conditions expected for the flight, at any point on its route or on any planned diversion from that route, the aeroplane is capable of a rate of climb of at least 300 feet per minute with all engines operating at no more than maximum continuous power at:

- a) the minimum altitudes for safe flight for each stage of the route to be flown, or of any planned diversion; and
- b) the minimum altitudes necessary to comply with the condition prescribed in paragraphs 3.5 and 3.6.

3.5 En-route – one engine inoperative

- a) In the meteorological conditions expected for the flight, and in the event of one engine becoming inoperative and the other engine or engines operating at no more than maximum continuous power, the aeroplane is capable of continuing the flight from the cruising altitude to an aerodrome where a safe landing can be made, clearing all obstacles within 5 NM either side of track by at least:
 - 1) 1 000 feet when rate of climb is zero or greater; or
 - 2) 2 000 feet when rate of climb is less than zero.
- b) The flight path shall have a positive gradient at 1 500 feet above the aerodrome where the landing is assumed to be made following engine failure.
- c) For the purposes of these calculations the available rate of climb of the aeroplane shall be taken as 150 feet per minute less than the gross rate of climb specified
- d) Fuel jettisoning is permitted to the extent consistent with reaching the aerodrome with the required fuel reserves.
- e) Track clearance to 5 NM either side of track may be used if navigational accuracy reaches at least 95% containment level.

3.6 En-route – aeroplanes with three or more engines, two engines inoperative

- a) Except as provided in sub-paragraph (b) below, each aeroplane with three or more engines is not more than 90 minutes away (at the all engines long-range cruising speed at standard temperature and in still air) from an aerodrome at which a safe landing can be made

- b) An aircraft with three or more engines may be operated at more than 90 minutes away from an aerodrome at which a safe landing can be made, provided that:
 - 1) the two engine inoperative flight path must permit the aeroplane to continue the flight, in the expected meteorological conditions expected for the flight, clearing all obstacles within 10 NM of the intended track to be flown, vertically by an altitude of at least 2 000 feet to an aerodrome at which a safe landing can be made; and
 - 2) the rate of climb of the aeroplane for the purpose of this paragraph shall be taken to be 150 feet per minute less than that specified; and
 - 3) fuel jettisoning is permitted to an extent consistent with reaching the aerodrome with the required reserves; and
 - 4) the expected mass of the aeroplane at the point where the two engines are assumed to fail shall be not less than that which would include sufficient fuel to proceed to an aerodrome where the landing is assumed to be made, and to arrive there at an altitude of at least 1500 feet directly over the aerodrome and after that to fly level for at least 15 minutes.
 - 5) it is assumed that the two engines fail at the most critical point of that portion of the route where the aeroplane is more than 90 minutes (at the all-engines long-range cruising speed at standard temperature and still air) away from an aerodrome at which a safe landing can be made.
- c) Track clearance to 5 NM either side of track may be used if navigational accuracy reaches at least 95% containment level.

3.7 Landing – destination and alternate aerodromes

The landing mass of the aeroplane does not exceed the maximum landing mass, taking into account the altitude and the ambient temperature expected for the estimated time of landing at the destination and alternate aerodrome.

3.8 Landing – dry runways

- a) The landing mass of the aeroplane allows a full stop landing from 50 feet above the threshold within 70% of the landing distance available at the destination and alternate aerodromes.
- b) The landing mass takes into account:
 - 1) the altitude at the aerodrome;
 - 2) the type of runway surface;
 - 3) the runway gradient in the direction of landing; and
 - 4) not more than 50% of the reported head-wind component or not less than 150% of the reported tail-wind component.
- c) It is assumed that the aeroplane will land on:

- 1) the most favourable runway in still air; and
 - 2) the aeroplane will land on the runway most likely to be assigned considering the probable wind speed and direction and the ground handling characteristics of the aeroplane, and also considering other conditions such as landing aids and terrain.
- d) If the operator is unable to comply with sub-paragraph (c)(2) for the destination aerodrome, the aeroplane may be despatched if an alternate aerodrome is designated which permits full compliance with sub-paragraphs (a), (b) and (c) above.

3.9 Landing – wet and contaminated runways

- a) When the appropriate weather reports or forecasts indicate that the runway at the estimated time of arrival may be wet, the landing distance available is at least 115% of the landing distance required by paragraph 3.8.
- b) When the appropriate weather forecasts and reports indicate that the runway expected at the time of landing may be contaminated, the landing distance required does not exceed the landing distance available.



INTENTIONALLY LEFT BLANK

17 Attachments

17.1 Attachment A – Medical supplies

Supplementary to Chapter 6, 6.2.3

Types, number, location and contents of medical supplies

1 Types

- 1.1 The different types of medical supplies should be provided as follows:
- 1.2 For aeroplanes authorised to carry more than 100 passengers on a sector length of more than two hours, universal precaution kit(s) should be carried for the use of cabin crew in managing incidents of ill health associated with a case of suspected communicable disease, or in the case of illness involving contact with body fluids.
- 1.3 Only a very small number of passengers are likely to benefit from the carriage of automated external defibrillators (AED) on aeroplanes. However, operators carry them because they offer the only effective treatment for cardiac fibrillation. The likelihood of use, and therefore of potential benefit to a passenger, is greatest in aircraft carrying a large number of passengers, over long duration sector lengths. The carriage of AEDs should be determined by operators on the basis of a risk assessment taking into account the particular needs of the operation.

2 Number of first-aid and universal precaution kits

2.1 First-aid kits

The number of first-aid kits should be appropriate to the number of passengers which the aeroplane is authorized to carry, refer to CAD 6, paragraph 6.2.3 for the quantities required.

2.2 Universal precaution kits

For routine operations, one or two universal precaution kits should be carried on aircraft that are required to operate with at least one cabin crew member. Additional kit(s) should be made available at times of increased public health risk, such as during an outbreak of a serious communicable disease having pandemic potential. Such kits may be used to clean up any potentially infectious body contents such as blood, urine, vomit and faeces and to protect the cabin crew members who are assisting potentially infectious cases of suspected communicable disease.

3 Location

- 3.1 First-aid and universal precaution kits should be distributed as evenly as practicable throughout the passenger cabins. They should be readily accessible to cabin crew members.
- 3.2 The emergency medical kit, when carried, should be stored in an appropriate secure location.

4 Contents

4.1 The following provides guidance on typical contents of first-aid, universal precaution and emergency medical kits.

4.1.1 First-aid kit:

List of contents

- Antiseptic swabs (10/pack)
- Bandage: adhesive strips
- Bandage: gauze 7.5 cm × 4.5 m
- Bandage: triangular; safety pins
- Dressing: burn 10 cm × 10 cm
- Dressing: compress, sterile 7.5 cm × 12 cm
- Dressing: gauze, sterile 10.4 cm × 10.4 cm
- Tape: adhesive 2.5 cm (roll)
- Steri-strips (or equivalent adhesive strip)
- Hand cleanser or cleansing towelettes
- Pad with shield, or tape, for eye
- Scissors: 10 cm (if allowed by national regulations)
- Tape: Adhesive, surgical 1.2 cm × 4.6 m
- Tweezers: splinter
- Disposable gloves (multiple pairs)
- Thermometers (non-mercury)
- Mouth-to-mouth resuscitation mask with one-way valve
- First-aid manual, current edition
- Incident record form

The following suggested medications can be included in the first-aid kits where permitted by national regulations:

- Mild to moderate analgesic
- Antiemetic
- Nasal decongestant

-Antacid

-Antihistamine

4.1.2 Universal precaution kit:

-Dry powder that can convert small liquid spill into a sterile granulated gel

-Germicidal disinfectant for surface cleaning

-Skin wipes

-Face/eye mask (separate or combined)

-Gloves (disposable)

-Protective apron

-Large absorbent towel

-Pick-up scoop with scraper

-Bio-hazard disposal waste bag

-Instructions

4.1.3 Medical kit:

Equipment

-List of contents

-Stethoscope

-Sphygmomanometer (electronic preferred)

-Airways, oropharyngeal (three sizes)

-Syringes (appropriate range of sizes)

-Needles (appropriate range of sizes)

-Intravenous catheters (appropriate range of sizes)

-Antiseptic wipes

-Gloves (disposable)

-Needle disposal box

-Urinary catheter

-System for delivering intravenous fluids

-Venous tourniquet

-Sponge gauze

-Tape – adhesive

- Surgical mask
- Emergency tracheal catheter (or large gauge intravenous cannula)
- Umbilical cord clamp
- Thermometers (non-mercury)
- Basic life support cards
- Bag-valve mask
- Flashlight and batteries

Medication

- Epinephrine 1:1 000
- Antihistamine – injectable
- Dextrose 50% (or equivalent) – injectable: 50 ml
- Nitroglycerin tablets, or spray
- Major analgesic
- Sedative anticonvulsant – injectable
- Antiemetic – injectable
- Bronchial dilator – inhaler
- Atropine – injectable
- Adrenocortical steroid – injectable
- Diuretic – injectable
- Medication for postpartum bleeding
- Sodium chloride 0.9% (minimum 250 ml)
- Acetyl salicylic acid (aspirin) for oral use
- Oral beta blocker

If a cardiac monitor is available (with or without an AED) add to the above list:

- Epinephrine 1:10 000 (can be a dilution of epinephrine 1:1 000)

Note.— The United Nations Conference for Adoption of a Single Convention on Narcotic Drugs in March 1961 adopted such a Convention, Article 32 of which contains special provisions concerning the carriage of drugs in medical kits of aircraft engaged in international flight.



17.2 Attachment B - Aeroplane performance operating limitations

-RESERVED (refer to Appendix 10)-



INTENTIONALLY LEFT BLANK



17.3 Attachment C. Guidance for operations by turbine-engined aeroplanes beyond 60 minutes to an en-route alternate aerodrome including Extended Diversion Time Operations (EDTO)

17.3.1 *-RESERVED-*



INTENTIONALLY LEFT BLANK



17.4 Attachment D. Air operator certification and validation
Supplementary to Chapter 4, 4.2.1

RESERVED



INTENTIONALLY LEFT BLANK

17.5 Attachment E. Minimum Equipment List (MEL)

Supplementary to Chapter 6, 6.1.3

- 1 If the requirements of the CAAM in the certification of aircraft are not met, an aircraft shall not be flown unless all systems and equipment are operable. Experience has proved that some unserviceability can be accepted in the short term when the remaining operative systems and equipment provide for continued safe operations.
- 2 The CAAM, through the approval of a minimum equipment list permits those systems and items of equipment that may be inoperative for certain flight conditions with the intent that no flight can be conducted with inoperative systems and equipment other than those specified.
- 3 A minimum equipment list, which is approved by the CAAM, is therefore necessary for each aircraft, based on the master minimum equipment list established for the aircraft type by the organisation responsible for the type design in conjunction with the State of Design.
- 4 The CAAM requires the operator to prepare a minimum equipment list designed to allow the operation of an aircraft with certain systems or equipment inoperative provided an acceptable level of safety is maintained.
- 5 The minimum equipment list is not intended to provide for operation of the aircraft for an indefinite period with inoperative systems or equipment. The basic purpose of the minimum equipment list is to permit the safe operation of an aircraft with inoperative systems or equipment within the framework of a controlled and sound programme of repairs and parts replacement.
- 6 Operators are to ensure that no flight is commenced with multiple minimum equipment list items inoperative without determining that any interrelationship between inoperative systems or components will not result in an unacceptable degradation in the level of safety and/or undue increase in the flight crew workload.
- 7 The exposure to additional failures during continued operation with inoperative systems or equipment must also be considered in determining that an acceptable level of safety is being maintained. The minimum equipment list may not deviate from requirements of the flight manual limitations section, emergency procedures or other airworthiness requirements of the State of Registry or of the CAAM unless provided otherwise by the Airworthiness Division of the CAAM or the flight manual.
- 8 Systems or equipment accepted as inoperative for a flight should be placarded where appropriate, and all such items should be noted in the aircraft journey log to inform the flight crew and maintenance personnel of the inoperative system or equipment.
- 9 For a particular system or item of equipment to be accepted as inoperative, it may be necessary to establish a maintenance procedure, for completion prior to flight, to deactivate or isolate the system or equipment. It may similarly be necessary to prepare an appropriate flight crew operating procedure.
- 10 The responsibilities of the pilot-in-command in accepting an aeroplane for operation with deficiencies in accordance with a minimum equipment list are specified in Chapter 4, 4.3.1.



INTENTIONALLY LEFT BLANK

17.6 Attachment F. Flight safety document system

Supplementary to Chapter 3, 3.3

1 Introduction

- 1.1 The following material provides guidance on the organisation and development of the operator's flight safety documents system. It should be understood that the development of a flight safety documents system is a complete process, and changes to each document comprising the system may affect the entire system. Guidelines applicable to the development of operational documents have been produced by government and industry sources and are available to operators. Nevertheless, it may be difficult for operators to make the best use of these guidelines, since they are distributed across a number of publications.
- 1.2 Furthermore, guidelines applicable to operational documents development tend to focus on a single aspect of documents design, for example, formatting and typography. Guidelines rarely cover the entire process of operational documents development. It is important for operational documents to be consistent with each other, and consistent with regulations, manufacturer requirements and Human Factors principles. It is also necessary to ensure consistency across departments as well as consistency in application. Hence the emphasis on an integrated approach, based on the notion of the operational documents as a complete system.
- 1.3 The guidelines in this Attachment address the major aspects of the operator's flight safety documents system development process, with the aim of ensuring compliance with Chapter 3, 3.4. The guidelines are based not only upon scientific research, but also upon current best industry practices, with an emphasis on a high degree of operational relevance.

2 Organisation

- 2.1 A flight safety documents system should be organised according to criteria which ensure easy access to information required for flight and ground operations contained in the various operational documents comprising the system and which facilitate management of the distribution and revision of operational documents.
- 2.2 Information contained in a flight safety documents system should be grouped according to the importance and use of the information, as follows:
 - a) time-critical information, e.g., information that can jeopardise the safety of the operation if not immediately available;
 - b) time-sensitive information, e.g., information that can affect the level of safety or delay the operation if not available in a short time period;
 - c) frequently used information;
 - d) reference information, e.g., information that is required for the operation but does not fall under b) or c) above; and
 - e) information that can be grouped based on the phase of operation in which it is used.
- 2.3 Time-critical information should be placed early and prominently in the flight safety documents system.

- 2.4 Time-critical information, time-sensitive information, and frequently used information should be placed in cards and quick-reference guides.

3 Validation

The flight safety documents system should be validated before deployment, under realistic conditions. Validation should involve the critical aspects of the information use, in order to verify its effectiveness. Interactions among all groups that can occur during operations should also be included in the validation process.

4 Design

- 4.1 A flight safety documents system should maintain consistency in terminology and in the use of standard terms for common items and actions.
- 4.2 Operational documents should include a glossary of terms, acronyms and their standard definition, updated on a regular basis to ensure access to the most recent terminology. All significant terms, acronyms and abbreviations included in the flight documents system should be defined.
- 4.3 A flight safety documents system should ensure standardisation across document types, including writing style, terminology, use of graphics and symbols, and formatting across documents. This includes a consistent location of specific types of information, consistent use of units of measurement and consistent use of codes.
- 4.4 A flight safety documents system should include a master index to locate, in a timely manner, information included in more than one operational document.

Note.— The master index must be placed in the front of each document and consist of no more than three levels of indexing. Pages containing abnormal and emergency information must be tabbed for direct access.

- 4.5 A flight safety documents system should comply with the requirements of the operator's quality system, if applicable.

5 Deployment

Operators should monitor deployment of the flight safety documents system, to ensure appropriate and realistic use of the documents, based on the characteristics of the operational environment and in a way which is both operationally relevant and beneficial to operational personnel. This monitoring should include a formal feedback system for obtaining input from operational personnel.

6 Amendment

- 6.1 Operators should develop an information gathering, review, distribution and revision control system to process information and data obtained from all sources relevant to the type of operation conducted, including, but not limited to, the CAAM, State of design, State of Registry, manufacturers and equipment vendors.

Note.— Manufacturers provide information for the operation of specific aircraft that emphasises the aircraft systems and procedures under conditions that may not fully match the requirements of operators. Operators should ensure that such information meets their specific needs and those of the local authority.

- 6.2 Operators should develop an information gathering, review and distribution system to process information resulting from changes that originate within the operator, including:

- a) changes resulting from the installation of new equipment;
- b) changes in response to operating experience;
- c) changes in the operator's policies and procedures;
- d) changes in the operator certificate; and
- e) changes for purposes of maintaining cross fleet standardisation.

Note.— Operators should ensure that crew coordination philosophy, policies and procedures are specific to their operation.

6.3 A flight safety documents system should be reviewed:

- a) on a regular basis (at least once a year);
- b) after major events (mergers, acquisitions, rapid growth, downsizing, etc.);
- c) after technology changes (introduction of new equipment); and
- d) after changes in safety regulations.

6.4 Operators should develop methods of communicating new information. The specific methods should be responsive to the degree of communication urgency.

Note.— As frequent changes diminish the importance of new or modified procedures, it is desirable to minimise changes to the flight safety documents system.

6.5 New information should be reviewed and validated considering its effects on the entire flight safety documents system.

6.6 The method of communicating new information should be complemented by a tracking system to ensure currency by operational personnel. The tracking system should include a procedure to verify that operational personnel have the most recent updates.



INTENTIONALLY LEFT BLANK



17.7 Attachment G. Additional guidance for approved operations by single-engine turbine-powered aeroplanes at night and/or in Instrument Meteorological Conditions (IMC)

Supplementary to Chapter 5, 5.4 and Appendix 3, Chapter 16.3

- 17.7.1 All operations involving single pilot under the instrument flight rules (IFR) or at night shall not be permitted in accordance with Regulation 49 of the MCAR 2016.



INTENTIONALLY LEFT BLANK

17.8 Attachment H. Automatic landing systems, displays and vision systems

Supplementary to Chapter 4, 4.2.8.1.1, and Chapter 6, 6.24

Introduction

The material in this attachment provides guidance for certified automatic landing systems, HUD or equivalent displays and vision systems intended for operational use in aeroplanes engaged in international air navigation. These systems and hybrid systems may be installed and operated to reduce workload, improve guidance, reduce flight technical error and enhance situational awareness and/or obtain operational credits. Automatic landing systems, HUD or equivalent displays and vision systems may be installed separately or together as part of a hybrid system. Any operational credit for their use requires a specific approval from the CAAM.

Note 1.— “Vision systems” is a generic term referring to the existing systems designed to provide images, i.e. enhanced vision systems (EVS), synthetic vision systems (SVS) and combined vision systems (CVS).

Note 2.— Operational credit can be granted only within the limits of the airworthiness approval.

Note 3.— Currently, operational credit has been given only to vision systems containing an image sensor providing a real-time image of the actual external scene on the HUD.

Note 4.— More detailed information and guidance on automatic landing systems, HUD or equivalent displays and vision systems is contained in the Manual of All-Weather Operations (ICAO Doc 9365). This manual should be consulted in conjunction with this attachment.

1 HUD and equivalent displays

1) General

- 1.1.1 A HUD presents flight information into the pilot’s forward external field of view without significantly restricting that external view.
- 1.1.2 A variety of flight information may be presented on a HUD depending on the intended flight operation, flight conditions, systems capabilities and operational approval. A HUD may include, but is not limited to, the following:
 - a) airspeed;
 - b) altitude;
 - c) heading;
 - d) vertical speed;
 - e) angle of attack;
 - f) flight path or velocity vector;
 - g) attitude with bank and pitch references;
 - h) course and glide path with deviation indications;
 - i) status indications (e.g. navigation sensor, autopilot, flight director); and

- j) alerts and warning displays (e.g. ACAS, wind shear, ground proximity warning)

1.2 Operational application

1.2.1 Flight operations with a HUD can improve situational awareness by combining flight information located on head-down displays with the external view to provide pilots with more immediate awareness of relevant flight parameters and situation information while they continuously view the external scene. This improved situational awareness can also reduce errors in flight operations and improve the pilot's ability to transition between instrument and visual references as meteorological conditions change. Flight operations application may include the following:

- a) enhanced situational awareness during all flight operations, but especially during taxi, take-off, approach and landing;
- b) reduced flight technical error during take-off, approach and landing; and
- c) improvements in performance due to precise prediction of touchdown area, tail strike awareness/warning and rapid recognition of and recovery from unusual attitudes.

1.2.2 A HUD may be used for the following purposes:

- a) to supplement conventional flight deck instrumentation in the performance of a particular task or operation. The primary cockpit instruments remain the primary means for manually controlling or manoeuvring the aircraft; and
- b) as a primary flight display;

1.2.3 information

- 1) information presented by the HUD may be used as a means to achieve additional navigation or control performance. The required information is displayed on the HUD. Operational credit, in the form of lower minima, for a HUD used for this purpose may be approved for a particular aircraft or automatic flight control system. Additional credit may also be allowed when conducting HUD operations in situations where automated systems are otherwise used.

1.2.3.1 A HUD, as a stand-alone system, may qualify for operations with reduced visibility or RVR or replace some parts of the ground facilities such as touchdown zone and/or centre line lights. Examples and references to publications in this regard can be found in the Manual of All-Weather Operations (ICAO Doc 9365).

1.2.3.2 A HUD equivalent display is one that has at least the following characteristics; a head-up presentation not requiring transition of visual attention from head down to head up; displays sensor derived imagery conformal with the pilot's external view; permits simultaneous view of the EVS sensor imagery, required aircraft flight symbology, and the external view; and display characteristics and dynamics are suitable for manual control of the aircraft. Before such systems can be used, the appropriate airworthiness and operational approvals must be obtained.

1.3 HUD training

- 1.3.1 HUD training should address all flight operations for which the HUD is designed and in accordance with applicable conditions in an approval. Some training elements may require adjustments based on whether the aeroplane has a single or dual HUD installation. Training should include contingency procedures required in the event of head-up display degradation or failure. HUD training should include the following elements as applicable to the intended use:
- a) an understanding of the HUD, its flight path, energy management concepts and symbology. This should include operations during critical flight events (e.g. ACAS Traffic Advisory/Resolution, Advisory, upset and wind shear recovery, engine or system failure);
 - b) HUD limitations and normal procedures, including maintenance and operational checks performed to ensure normal system function prior to use. These checks include pilot seat adjustment to attain and maintain appropriate viewing angles and verification of HUD operating modes;
 - c) HUD use during low visibility operations, including taxi, take-off, instrument approach and landing in both day and night conditions. This training should include the transition from head down to head-up and head-up to head-down operations;
 - d) failure modes of the HUD and the impact of the failure modes or limitations on crew performance;
 - e) crew coordination, monitoring and verbal call-out procedures for single HUD installations with head-down monitoring for the pilot not equipped with a HUD and head-up monitoring for the pilot equipped with a HUD;
 - f) crew coordination, monitoring and verbal call-out procedures for dual HUD installations with use of a HUD by the pilot flying the aircraft and either head-up or head-down monitoring by the other pilot;
 - g) consideration of the potential for loss of situational awareness due to "tunnel vision" (also known as cognitive tunnelling or attention tunneling);
 - h) any effects that weather, such as low ceilings and visibilities, may have on the performance of HUD; and
 - i) HUD airworthiness requirements.

2 Vision systems

2.1 General

- 2.1.1 Vision systems can display electronic real-time images of the actual external scene achieved through the use of image sensors (EVS) or display synthetic images, which are derived from the on-board avionic systems (SVS). Vision systems can also consist of a combination of these two systems or combined vision systems (CVS). Such a system may display electronic real-time images of the external scene using the EVS component of the system. However, the merging of EVS and SVS into a CVS is dependent on the intended function (e.g. whether or not there is intent to achieve operational credit).

- 2.1.2 The information from vision systems may be displayed on a head-up or head-down display. When enhanced vision imagery is displayed on a HUD, it should be presented to the pilot's forward external field of view without significantly restricting that external view.
- 2.1.3 The enhanced position fixing and guidance provided by SVS may provide additional safety for all phases of flight especially low visibility taxi, take-off, approach and landing operations.
- 2.1.4 Light emitting diode (LED) lights may not be visible to infrared-based vision systems due to the fact that LED lights are not incandescent and they do not have a significant heat signature. Operators of such vision systems will need to acquire information about the LED implementation programmes at aerodromes where they operate.

2.1.5

2.2 Operational applications

- 2.2.1 Flight operations with enhanced vision image sensors allow the pilot to view an image of the external scene obscured by darkness or other visibility restrictions. When the external scene is partially obscured, enhanced vision imaging may allow the pilot to acquire an image of the external scene earlier than with natural or unaided vision. The improved acquisition of an image of the external scene may improve situational awareness.
- 2.2.2 Vision system imagery may also allow pilots to detect terrain or obstructions on the runway or taxiways. A vision system image can also provide visual cues to enable earlier runway alignment and a more stabilised approach.
- 2.2.3 The combined display of aircraft performance, guidance and imagery may allow the pilot to maintain a more stabilised approach and smoothly transition from enhanced visual references to natural visual references.

2.3 Operational concepts

- 2.3.1 Instrument approach operations include an instrument phase and a visual phase. The instrument phase ends at the published MDA/H or DA/H unless a missed approach is initiated. Using the EVS or CVS does not change the applicable MDA/H or DA/H. The continued approach to landing from MDA/H or DA/H will be conducted using visual references. The visual references will be acquired by use of an EVS or CVS, natural vision, or a combination of EVS/ CVS with natural vision.
- 2.3.2 Down to a defined height, typically 30 m (100 ft), the visual references will be acquired by means of the vision system. Below this height the visual references should be solely based on natural vision. In the most advanced applications, the vision system is expected to be able to be used down to touchdown without the requirement for natural vision acquisition of visual references. Using the EVS or CVS does not change the classification of an instrument approach procedure, since the published DA/H remains unchanged and manoeuvring below DA/H is conducted by visual references acquired by means of the an EVS or CVS.
- 2.3.3 In addition to the operational credit that EVS/ CVS is able to provide, these systems may also provide an operational and safety advantage through improved situational awareness, earlier acquisition of visual references and smoother transition to

references by natural vision. These advantages are more pronounced for Type A approach operations than for Type B approach operations.

EVS operations

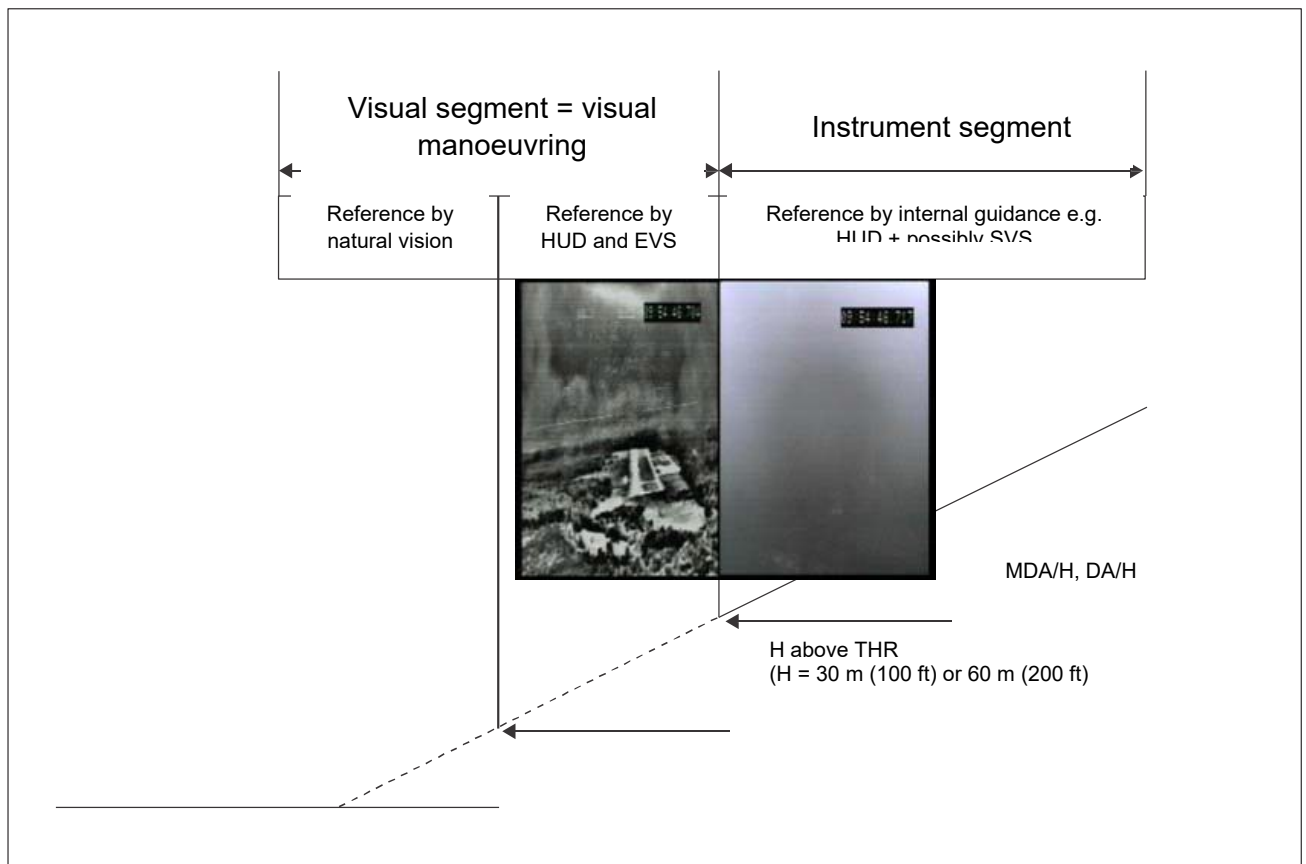

Figure 1. EVS operations — transition from instrument to visual references

2.4 Vision systems training

- 2.4.1 Training should address all flight operations for which the vision system is approved. This training should include contingency procedures required in the event of system degradation or failure. Training for situational awareness should not interfere with other required operations. Training for operational credit should also require training

on the applicable HUD used to present the enhanced visual imagery. Training should include the following elements as applicable:

- a) an understanding of the system characteristics and operational constraints;
- b) normal procedures, controls, modes and system adjustments (e.g. sensor theory including radiant versus thermal energy and resulting images);
- c) operational constraints, normal procedures, controls, modes, and system adjustments;
- d) limitations;
- e) airworthiness requirements;
- f) vision system display during low visibility operations, including taxi, take-off, instrument approach and landing; system use for instrument approach procedures in both day and night conditions;
- g) failure modes and the impact of failure modes or limitations upon crew performance, in particular, for two-pilot operations;
- h) crew coordination and monitoring procedures and pilot call-out responsibilities;
- i) transition from enhanced imagery to visual conditions during runway visual acquisition;
- j) rejected landing: with the loss of visual cues of the landing area, touchdown zone or rollout area;
- k) any effects that weather, such as low ceilings and visibilities, may have on the performance of the vision system; and
- l) effects of aerodrome lighting using LED lights.

2.5 Visual references

2.5.1 The required visual references do not change due to the use of an EVS or CVS, but those references are allowed to be acquired by means of either vision system until a certain height during the approach.

2.5.2 In regions that have developed requirements for operations with vision systems, the visual references are indicated in Figure 1 above.

OPERATIONS BELOW DA/DH or MDA/MDH	
Example 1	Example 2
<p>For procedures designed to support Type A operations, the following visual references for the intended runway must be distinctly visible and identifiable:</p> <ul style="list-style-type: none"> a) the approach lighting system; or b) the runway threshold, identified by at least one of the following: <ul style="list-style-type: none"> -the beginning of the runway landing surface; -threshold lights; or 	<p>For procedures designed to support 3D Type A and Type B Cat I operations, the following visual references should be displayed and identifiable to the pilot on the EVS image:</p> <ul style="list-style-type: none"> a) elements of the approach lighting system; or b) the runway threshold, identified by at least one of the following:

-runway end identifier lights; and c)the touchdown zone, identified by at least one of the following: -the runway touchdown zone landing surface; -touchdown zone lights; -touchdown zone markings; or -runway lights	-the beginning of the runway landing surface; -threshold lights; -threshold identification lights; or -the touchdown zone, identified by at least one of the following: 1)the runway touchdown zone 2)landing surface 3)touchdown zone lights 4)touchdown zone 5)runway lights
Operations below 60m (200 ft) above touchdown zone elevation -	Operations below 60m (200 ft) above threshold elevation -
No additional requirements apply at 60m (200 ft)	For procedures designed to support 3D Type A operations, the visual references are the same as those specified below for Type B Cat I operations.
Operations below 30m (100 ft) above touchdown zone elevation -	Operations below 30m (100 ft) above threshold elevation -
The visibility must be sufficient for the following to be distinctly visible and identifiable to the pilot without reliance on the EVS: a)the lights or markings of the threshold; or b)the lights or markings of the touchdown zone.	For procedures designed to support Type B Cat II operations, at least one of the visual references specified below should be distinctly visible and identifiable to the pilot without reliance on the EVS: a)the lights or markings of the threshold; or b)the lights or markings of the touchdown zone.

Table 1.

3 Hybrid systems

- 3.1 A hybrid system generically means that two or more systems are combined. The hybrid system typically has improved performance compared to each of the component systems, which in turn may qualify for operational credit. Vision systems are normally part of a hybrid system, e.g. EVS is typically combined with a HUD. Including more components in the hybrid system normally enhances the performance of the system.
- 3.2 Table 2 provides some examples of hybrid system components. Any combination of the listed systems may constitute a hybrid system. The degree of operational credit that may be given to a hybrid system depends on its performance (accuracy, integrity and availability) as assessed and determined by the certification and operational approval processes.

Systems based on image sensors	Systems not based on image sensors
EVS	SVS
-Passive infrared sensors	Auto-flight systems, flight control computers, automatic landing systems
-Active infrared sensors	Systems for position fixing
-Passive millimetre wave radiometer	CVS (the SVS component)
-Active millimetre wave radar	HUD, equivalent display
CVS (where the EVS component as above qualifies for operational credit)	ILS, GNSS

Table 2. Examples of hybrid system components

4 Operational credits

- 4.1 Aerodrome operating minima are expressed in terms of minimum visibility/RVR and MDA/H or DA/H. With respect to operational credit this means that the visibility/RVR requirements, established in the instrument approach procedure, may be reduced or satisfied for aircraft equipped with appropriately approved vision systems such as EVS. Reasons for granting operational credit may be when aircraft are better equipped than what was originally considered when designing the instrument approach procedure or when runway visual aids considered in the design of the procedure are not available but can be compensated by on-board equipment.
- 4.2 Credits related to visibility/RVR can be given using at least three concepts. The first concept is to reduce the required RVR which will allow the aircraft to continue the approach beyond the approach ban point with a reported RVR lower than what was established for the approach procedure. Where a minimum visibility is prescribed, a second concept to grant operational credit may be used. In this case, the required minimum visibility is kept unchanged, but it is satisfied by means of the on-board equipment, typically an EVS. The result of both these concepts is that operations are allowed in meteorological conditions where otherwise they would not be possible. A third concept is to give operational credit by allowing operations in visibility/RVR which are not lower than those established for the approach procedure, but the approach operation is conducted with less facilities on the ground. One example of the latter is to allow category II operations without touchdown and/or centre line lights, compensated by additional on-board equipment, e.g. a HUD.
- 4.3 Granting operational credits does not affect the classification of an instrument approach procedure since instrument approach procedures are designed to support a given instrument approach operation (i.e. Type, Category). However, the design of those procedures should not take into consideration on-board equipment that may compensate for facilities on the ground.
- 4.4 In order to provide optimum service, the ATS may have to be informed about the capabilities of better-equipped aircraft, e.g. which is the minimum RVR required.
- 4.5 In addition to the operational credit that a HUD, vision systems and hybrid systems are able to provide, these systems will also provide an operational and safety advantage through improved situational awareness, earlier acquisition of visual references and smoother transition to references by natural vision. These advantages are more pronounced for 3D Type A approach operations than for Type B approach operations.

5 Operational procedures

- 5.1 It is not prohibited to use vision systems in connection with circling. However, due to the system layout of a vision system and the nature of a circling procedure, key visual references can be obtained only by natural vision, and operational credit is not feasible for existing vision systems. The vision system may provide additional situational awareness.
- 5.2 The operational procedures associated with the use of a HUD, vision systems and hybrid systems should be included in the operations manual. The instructions in the operations manual should include:
 - a) any limitation that is imposed by the airworthiness or operational approvals;

- b) how operational credit affects:
 - a) flight planning with respect to destination and alternate aerodromes;
 - b) ground operations;
 - c) flight execution, e.g. approach ban and minimum visibility;
 - d) crew resource management that takes into account the equipment configuration, e.g. the pilots may have different presentation equipment;
 - e) standard operating procedures, e.g. use of auto-flight systems, call-outs that may be particular to the vision system or hybrid system, criteria for stabilised approach;
 - f) ATS flight plans and radio communication.

6 Approvals

6.1 General

- 6.1.1 An operator that wishes to conduct operations with a HUD or equivalent display, vision system or hybrid system will need to obtain an approval from the CAAM. The extent of the approval will depend on the intended operation and the complexity of the equipment.
- 6.1.2 Enhanced vision imagery may be used to improve situational awareness without a specific operational approval. However, the standard operating procedures for these types of operations need to be specified in the operations manual. An example of this type of operation may include an EVS or an SVS on a head-down display that is used only for situational awareness of the surrounding area of the aircraft during ground operations where the display is not in the pilot's primary field of view. For enhanced situational awareness, the installation and operational procedures need to ensure that the operation of the vision system does not interfere with normal procedures or the operation or use of other aircraft systems. In some cases, modifications to these normal procedures for other aircraft systems or equipment may be necessary to ensure compatibility.
- 6.1.3 When a vision system or a hybrid system with vision systems imagery is used for operational credit, operational approvals will typically require that the imagery be combined with flight guidance and presented on a HUD. An operational approval may include a condition that this information also be presented on a head-down display. Operational credit may be applied for any flight operation, but credit for instrument approach and take-off operations is most common.
- 6.1.4 Operators should be aware that some States may require some information about the operational credit(s) which has been granted by the CAAM.
- 6.1.5 Approvals for operational credit
- 6.1.6 To obtain operational credit, the operator will need to specify the desired operational credit and submit an application to the CAAM. The content of such an application should include:
 - a) Applicant details. The AOC holder's company name, AOC number and email.
 - b) Aircraft details. Aircraft make(s), model(s) and registration mark(s).
 - c) Operator's vision system compliance list. The contents of the compliance list are included in the Manual of All- Weather Operations (Doc 9365). The compliance

list should include the information that is relevant to the specific approval requested and the registration marks of the aircraft involved. If more than one type of aircraft/fleet is included in a single application, a completed compliance list should be included for each aircraft/fleet.

- d) Documents to be included with the application. Copies of all documents to which the operator has made references should be included in the application. There should be no need to send complete manuals; only the relevant sections/pages should be required. Additional guidance material can be found in the Manual of All-Weather Operations (Doc 9365).
- e) Name, title and signature.

6.2 The following items should be covered in a vision systems compliance list:

- a) reference documents used in compiling the submission for approval;
- b) flight manual;
- c) feedback and reporting of significant problems;
- d) requested operational credit and resulting aerodrome operating minima;
- e) operations manual entries including MEL and standard operating procedures;
- f) safety risk assessments;
- g) training programmes; and
- h) continuing airworthiness.

Expanded guidance on these items is contained in the Manual of All-Weather Operations (ICAO Doc 9365).

17.9 Attachment I. Rescue and Fire Fighting Services (RFFS) levels

Supplementary to Chapter 4, 4.1.5

1 Purpose and scope

1.1 Introduction

The purpose of this Attachment is to provide guidance for assessing the level of RFFS deemed acceptable by aeroplane operators using aerodromes for differing purposes. This guidance does not relieve the operator from the obligation to ensure that an acceptable level of protection is available for the aeroplane intended to be used.

1.2 Basic concepts

1.2.1 For flight planning purposes, an aeroplane operator should utilise an aerodrome whose RFFS category, as required by CAD 14, Volume I, Chapter 9, 9.2, matches or exceeds the aeroplane's RFFS category. Some aerodromes currently used do not, however, meet these requirements. Furthermore, CAD 14, Volume I provisions relate to the level of aerodrome RFFS to be provided for aeroplanes normally using an aerodrome; hence, this level of RFFS protection does not take into account aeroplanes for which the aerodrome is selected as an alternate aerodrome.

1.2.2 If an aerodrome is exposed to a temporary reduction of its RFFS capability, CAD 14, Volume I, 2.11.3, requires that: "Changes in the level of protection normally available at an aerodrome for rescue and fire fighting shall be notified to the appropriate air traffic services units and aeronautical information services units to enable those units to provide the necessary information to arriving and departing aircraft. When such a change has been corrected, the above units shall be advised accordingly."

1.2.3 In order to determine the acceptability of an aerodrome RFFS protection level, the operator should consider:

- a) for a departure or destination aerodrome, the difference between the aerodrome RFFS category and the aeroplane RFFS category, and the frequency of flights to that aerodrome; and
- b) for an alternate aerodrome, the difference between the aerodrome RFFS category and the aeroplane RFFS category, and the probability that this alternate aerodrome will be used.

1.2.4 The intention is that the operator will consider the available RFFS as one element of a risk assessment process conducted under their safety management system (SMS), to ensure that the overall safety of the operation can be maximised. This risk assessment would also include considerations of aerodrome facilities, availability, terrain, weather conditions, etc. to ensure that the most appropriate aerodrome is selected.

Note.— CAD 19 includes safety management provisions for air operators. Further guidance is contained in the Safety Management Manual (SMM) (ICAO Doc 9859).

1.2.5 The following guidance is intended to assist operators in making the assessment required by Chapter 4, 4.1.4 with due consideration of the basic principles described in 1.2.1 to 1.2.4. It is not intended that this guidance limit or regulate the operation of an aerodrome.

2 Glossary of terms

Aerodrome RFFS category. The RFFS category for a given aerodrome, as published in the appropriate Aeronautical Information Publication (AIP).

Aeroplane RFFS category. The category derived from CAD 14, Volume I, Table 9-1 for a given aeroplane type.

Temporary downgrade. RFFS category as notified, including by NOTAM, and resulting from the downgrade of the level of RFFS protection available at an aerodrome.

3 Minimum acceptable aerodrome RFFS category

3.1 Planning

3.1.1 In principle, the published RFFS category for each of the aerodromes used for a given flight should be equal to or better than the aeroplane’s RFFS category. However, if the aeroplane’s RFFS category is not available at one or more of the aerodromes required to be specified in the operational flight plan, the operator should ensure that the aerodrome has a level of RFFS category which is deemed acceptable, based on a risk assessment conducted as part of the operator’s safety management system (SMS). When establishing acceptable levels of RFFS category for these situations, the operator may use the criteria in Table I-1 and Table I-2. Notwithstanding these criteria, the operator may determine other acceptable levels of RFFS category in accordance with 3.1.3 of this attachment.

3.1.1.1 Intended operations to aerodromes with RFFS categories below the levels specified in CAD 14, Volume I, Chapter 9, 9.2, should be coordinated between the aeroplane operator and the aerodrome operator.

3.1.1.2 For departure and destination aerodromes, during flight planning, the acceptable RFFS protection level should equal or exceed the values specified in Table I-1.

Table I-1. Acceptable aerodrome category for rescue and fire fighting (departure and destination aerodrome)

Aerodromes	Acceptable aerodrome RFFS category
(Required to be specified in the operational flight plan) (1)	(Based on published aerodrome RFFS category, including any modification by NOTAM)
Note.— If an individual aerodrome serves more than one purpose, the highest required category corresponding to that purpose at the time of expected use applies.	

<p>Departure and destination aerodrome</p>	<p>RFFS category for each aerodrome should be equal to or better than the aeroplane RFFS category.</p> <p>Where a suitable risk assessment has been conducted by the operator:</p> <p>One category below the aeroplane RFFS category, or</p> <p>Two categories below the aeroplane RFFS category, in the case of a temporary downgrade of 72 hours or less but not lower than aerodrome RFFS Category 4 for aeroplanes with maximum certificated take-off mass of over 27 000 kg and not lower than Category 1 for other aeroplanes.</p>
--	--

3.1.1.3 So as to comply with the operational regulations applicable to a given flight, the operator selects alternate aerodrome(s) for various uses. During flight planning, the acceptable aerodrome RFFS category at a selected alternate aerodrome may equal or exceed the values specified in Table I-2.

Table I-2. Acceptable aerodrome category for rescue and firefighting (alternate aerodromes)

<p>Aerodromes</p>	<p>Acceptable aerodrome RFFS protection level</p>
<p>(Required to be specified in the operational flight plan)</p> <p>Note.— If an individual aerodrome serves more than one purpose, the highest required category corresponding to that purpose at the time of expected use</p>	<p>(Based on published aerodrome RFFS category, including any modification by NOTAM)</p>
<p>Take-off alternate and destination alternate aerodromes</p>	<p>Where a suitable risk assessment has been conducted by the operator:</p> <p>Two categories below the aeroplane RFFS category, or</p> <p>Three categories below the aeroplane RFFS category in the case of a temporary downgrade of 72 hours or less but not lower than aerodrome RFFS Category 4 for aeroplanes with maximum certificated take-off mass of over 27 000 kg and not lower than Category 1 for other aeroplanes.</p>

<p>En-route alternate aerodromes</p>	<p>If at least 30 minutes notice is given to the aerodrome operator prior to the arrival of the aeroplane, a minimum of RFFS Category 4 for aeroplanes with maximum certificated take-off mass of over 27 000 kg, and RFFS Category 1 for other aeroplanes.</p> <p>If less than 30 minutes notice can be given to the aerodrome operator prior to the arrival of the aeroplane:</p> <p>Two categories below the aeroplane RFFS category, or</p> <p>Three categories below the aeroplane RFFS category in the case of a temporary downgrade of 72 hours or less</p> <p>but not lower than aerodrome RFFS Category 4 for aeroplanes with maximum certificated take-off mass of over 27 000 kg and not lower than Category 1 for other aeroplanes.</p>
--------------------------------------	---

3.1.2 For all-cargo operations, further reductions might be acceptable provided that the RFFS capability is adequate to arrest fire around the flight deck area long enough for the persons on board to safely evacuate the aeroplane.

3.1.3 Variations

3.1.3.1 Notwithstanding the guidance developed in 3.1.1, an aerodrome RFFS category below the protection levels defined in Tables I-1 and I-2 may be acceptable if other considerations prevail, such as weather conditions, runway(s) characteristics, or length of diversion. Such variations should be based on a specific risk assessment conducted by the operator as part of its safety management system (SMS).

3.1.3.2 Variations to the aerodrome RFFS category may concern, among other cases:

- a) an occasional flight; or
- b) temporary downgrades exceeding 72 hours.

Where applicable, a variation may be used for a group of aerodromes selected for the same purpose, for a given aeroplane type.

3.1.3.3 The aforementioned variations may be based on additional or other criteria relevant to the type of operations. For instance, the 72-hour threshold for RFFS temporary downgrades may not be relevant for a single flight to or from the aerodrome concerned, such as a non-scheduled flight, whereas it is fully relevant for operations carried out on a continuous and daily basis. A variation may be time limited. A variation may also be modified to reflect the changes of the RFFS protection level available at the aerodrome(s) concerned. In accordance with Chapter 4, 4.1.5, the variations and their validity periods should be included in the operations manual.

3.1.3.4 For variations to the acceptable RFFS category at departure and destination aerodromes, the aeroplane operator's specific safety risk assessment for an aerodrome intended to be used as a departure or destination aerodrome may be based on the following elements:

- a) the frequency of flights intended by the aeroplane operator in relation to a lowered aerodrome RFFS category;
 - b) coordination between the aeroplane operator and the aerodrome operator (for instance, reducing intervention time by prepositioning the existing RFFS means along the runway before the intended take-off or landing).
- 3.1.3.5 For regular flights, the coordination should take into account the principles of CAD 14, Volume I, Chapter 9, 9.2.5 and 9.2.6 which are applicable to the aerodrome operator, as well as the possibilities to modulate the aerodrome RFFS category available on a daily cycle or seasonal cycle.
- 3.1.3.6 For variations in acceptable RFFS for an alternate aerodrome, the aeroplane operator's specific safety risk assessment for an aerodrome selected as a take-off alternate aerodrome, a destination alternate aerodrome or an en-route alternate aerodrome may be based on the following elements:
- a) the probability of effective use of the aerodrome concerned; and
 - b) the frequency of selection of the aerodrome for the respective purpose of use.
- 3.2 In flight
- 3.2.1 The information contained in the operations manual according to Chapter 4, 4.1.5 about the aerodrome RFFS category acceptable at the planning stage (including Tables I-1, I-2 and, where usable, the variations under the specifications in 3.1.3) is applicable at the in-flight re-planning point.
- 3.2.2 In flight, the pilot-in-command may decide to land at an aerodrome regardless of the RFFS category if, in the pilot's judgement after due consideration of all prevailing circumstances, to do so would be safer than to divert.



INTENTIONALLY LEFT BLANK

17.10 Attachment J. Dangerous goods

Supplementary to Chapter 14

1 Purpose and scope

The material in this attachment provides guidance regarding the carriage of dangerous goods as cargo. Chapter 14 of CAD 6, includes dangerous goods operational requirements that apply to all operators. Operators that are approved to transport dangerous goods as cargo need to meet additional requirements. In addition to the operational requirements contained in CAD 6, there are other requirements in CAD 18 and the Technical Instructions that also need to be complied with.

2 Definitions

Where the following term is used in this attachment, it has the meaning indicated:

Cargo. Any property carried on an aircraft other than mail and accompanied or mishandled baggage.

Note 1.— This definition differs from the definition of “cargo” given in CAD 9 — Facilitation.

Note 2.— COMAT that meets the classification criteria of dangerous goods and which is transported in accordance with Part 1;2.2.2 or Part 1;2.2.3 or Part 1;2.2.4 of the Technical Instructions are considered as “cargo” (e.g. aircraft parts such as chemical oxygen generators, fuel control units, fire extinguishers, oils, lubricants, cleaning products).

3 States

- 3.1 The CAAM will indicate in the operations specification if the operator is approved or is not approved to transport dangerous goods as cargo. When the operator is approved to transport dangerous goods as cargo, any limitations should be included.
- 3.2 An operational approval may be granted for the transport of specific types of dangerous goods only (e.g. dry ice; biological substance, Category B; and dangerous goods in excepted quantities) or COMAT.
- 3.3 Carriage of dangerous goods other than as cargo (e.g. medical flights, search and rescue) are addressed in Part 1, Chapter 1, of the Technical Instructions. The exceptions for the carriage of dangerous goods that are either equipment or for use on board the aircraft during flight are detailed in Part 1, 2.2.1, of the Technical Instructions.

4 Operator

- 4.1 The operator's training programme should cover, as a minimum, the aspects of the transport of dangerous goods listed in the Technical Instructions in Table 1-4 for operators holding an approval or Table 1-5 for operators without an approval. Recurrent training must be provided within 24 months of previous training, except as otherwise provided by the Technical Instructions.
- 4.2 Details of the dangerous goods training programme including the policies and procedures regarding third-party personnel involved in the acceptance, handling,



loading and unloading of dangerous goods cargo should be included in the operations manual.

- 4.3 The Technical Instructions require that operators provide information in the operations manual and/or other appropriate manuals that will enable flight crews, other employees and ground handling agents to carry out their responsibilities with regard to the transport of dangerous goods and that initial training be conducted prior to performing a job function involving dangerous goods.
- 4.4 Operators should meet and maintain requirements established by the States in which operations are conducted in accordance with 4.2.2.2 of this CAD.
- 4.5 Operators may seek approval to transport, as cargo, specific dangerous goods only, such as dry ice, biological substance, Category B, COMAT and dangerous goods in excepted quantities.
- 4.6 Attachment 1 to Part S-7, Chapter 7, of the Supplement to the Technical Instructions contains additional guidance and information on requirements regarding operators not approved to transport dangerous goods as cargo and for operators that are approved to transport dangerous goods as cargo.
- 4.7 All operators should develop and implement a system that ensures they will remain current with regulatory changes and updates. The Technical Instructions contain detailed instructions necessary for the safe transport of dangerous goods by air. These instructions are issued biennially, becoming effective on 1 January of an odd-numbered year.

17.11 Attachment K. Location of an aeroplane in distress

(Supplementary to Chapter 6, 6.18)

Guidance for location of an aeroplane in distress**1 Introduction**

- 1.1 The following material provides guidance on locating an aeroplane in distress. The Triggered Transmission of Flight Data Working Group (TTFDWG) reviewed forty-two accidents to determine an indication of the distance from a last-known aeroplane position to the location of an accident site. The report concluded that in approximately 95 per cent of the cases, when the aircraft position was known one minute prior to the accident, the accident site location was within a 6 NM radius of that position.
- 1.2 When an aeroplane has an accident into water and becomes submerged, the location of the accident site within a 6 NM radius on the surface becomes more important. Starting the initial search area beyond a 6 NM radius reduces the amount of time available to search for and locate the aeroplane. At current estimated underwater search capabilities of 100 km²/day, an area with a 6 NM radius could be searched in four days. Allowing for naval assets to reach the search area and conduct the search, it is estimated that an area of 2 300 km², equivalent to a radius of 14 NM, will be able to be searched before the underwater locator device battery degrades. Starting at an area of more than 6 NM radius reduces the probability of a successful location during an initial search, whilst extending the location requirement beyond 6 NM radius reduces the time available to search with no appreciable gain in the probability of recovery.

2 Clarification of purpose of equipment

- 2.1 Information from which a position can be determined: Information from an aircraft system which either is active, or, when automatically or manually activated, can provide position information which includes a time stamp. This is a performance-based requirement which is not system-specific and may also bring operational benefits.
- 2.2 Emergency locator transmitter (ELT): The current generation of ELTs were designed to provide the position of impact for a survivable accident. The next generation of ELTs may have the capability to activate a transmission in flight when any of the conditions detailed in EUROCAE ED-237, Minimum Aviation System Performance Specification (MASPS) for Criteria to Detect In-Flight Aircraft Distress Events to Trigger Transmission of Flight Information are met. When an ELT sinks below the surface of water, its signal is not detectable.
- 2.3 Automatic deployable flight recorder (ADFR): The purpose of an ADFR is to have flight recorder data available soon after an accident, in particular for accidents over water. The integrated ELT provides for both locating the accident site for accident investigation and search and rescue purposes. Being floatable, it will assist in locating the accident site by providing an ELT signal when the wreckage sinks below the surface of the water. It also ensures redundancy for one ELT.
- 2.4 Underwater locator device (ULD): A ULD operating at a frequency of 8.8 kHz is attached to the airframe to locate aeroplane wreckage below the surface of water when an ELT signal is not possible to detect. The ULDs operating at 37.5 kHz are attached to the flight recorders and are used for locating the flight recorders under water.

3 Equipage compliance

The advancement of technology has made it possible to meet the equipage requirements by different means. Table K-1 below provides examples of compliance. In such potential installations, the cost will be minimised and the effectiveness of the current installation improved.

Table K-1. Examples of compliance

Current	After 1 January 2021
In-service	Application for type certification is submitted to a Contracting State
<p>Two ELTs</p> <p>Two fixed recorders</p>	<p>Example:</p> <p>A system from which a position can be determined; and one ADFR with an integrated ELT; and one combined recorder;</p> <p>or</p> <p>A system from which a position can be determined and one ELT and two fixed recorders and an additional means to retrieve flight recorder data in a timely manner.</p>

Note.— A system from which a position can be determined and used to comply with Chapter 6, 6.18, may replace one of the ELTs required by Chapter 6, 6.17.

17.12 Attachment L. Guide to current flight recorder provisions

(Supplementary to Chapter 6, 6.3)

1 Introductions

Since 1973, and the inclusion in Annex 6 of SARPs for the carriage of flight recorders, new and revised requirements were introduced concerning flight recorders. These amendments include an update of the provisions pertaining to flight recorders, recording of digital communications, FDR requirements for new aircraft, revised parameter listings; two-hour duration CVRs. Through the years, the applicability date and the carriage of flight recorders to be installed, as defined by the SARPs, were complex.

The tables below summarise the current flight recorders carriage requirements.

Table L-1. FDR/AIR/ADRS/AIRS installation SARPs

Date	MCTOM								
	Over 27 000 kg			Over 5 700 kg			5 700 kg and below		
	All aeroplanes new type certificate	All aeroplanes first certificate of airworthiness	All turbine aeroplanes first certificate of airworthiness	All aeroplanes new type certificate	All aeroplanes first certificate of airworthiness	All turbine aeroplanes first certificate of airworthiness	All turbine aeroplanes new type certificate	All turbine aeroplanes first certificate of airworthiness	Multi-turbine aeroplanes first certificate of airworthiness
			6.3.1.1.6				6.3.1.1.6		
1987			6.3.1.1.8				6.3.1.1.7		
1989 ⇒									
1990 ⇒		6.3.1.1.3			6.3.1.1.4				
2005 ⇒									6.3.1.1.5
2016 ⇒	Table A8-1 (Some parameters are sampled at an increased	6.3.1.1.10		Table A8-1 (Some parameters are sampled at an increased	6.3.1.1.10		6.3.1.1.1	6.3.1.1.2	
2023 ⇒	6.3.1.1.11	6.3.1.1.12		6.3.1.1.11	6.3.1.1.12				

Table L-2. CVR/CARS installation SARPs

Date	Over 27 000 kg		Over 5 700 kg		Over 2 250 kg	
	All aeroplanes	All turbine aeroplanes first certificate of airworthiness	All aeroplanes first certificate of airworthiness	All turbine aeroplanes first certificate of airworthiness	All turbine aeroplanes more than 1 pilot new type certificate	All turbine aeroplanes more than 1 pilot first certificate of airworthiness
					6.3.2.1.5	
1987 ⇒						
2003 ⇒						
2016 ⇒	6.3.2.3.1					
2021 ⇒	6.3.2.3.2	6.3.2.1.4	6.3.2.1.3		6.3.2.1.1	6.3.2.1.2

Table L-3. Combination recorder installation SARPs

	MCTOM			
Date	Over 15 000 kg	Over 5 700 kg		Less than 5 700 kg
	All aeroplanes new type certificate	All aeroplanes new type certificate	All aeroplanes requiring CVR and FDR	All multi-engined turbine-powered aeroplanes requiring
2016 ⇒	6.3.5.5.2	6.3.5.5.1	6.3.5.5.3	6.3.5.5.4

Table L-4. Flight crew-machine interface recordings

Date	MCTOM	
	Over 27 000 kg	Over 5 700 kg
	All aeroplanes new type certificate	All aeroplanes first certificate of airworthiness
2023 ⇒	6.3.4.1.1	6.3.4.1.2

INTENTIONALLY LEFT BLANK