

GSE & TOOL MANUAL

TITLE	TOOL KIT, GIMBAL / TORQUE TUBE BUSHINGS REPL. FOR MGB EQUIPPED WITH AGB SYSTEM P/N 3G6305G29431
--------------	--

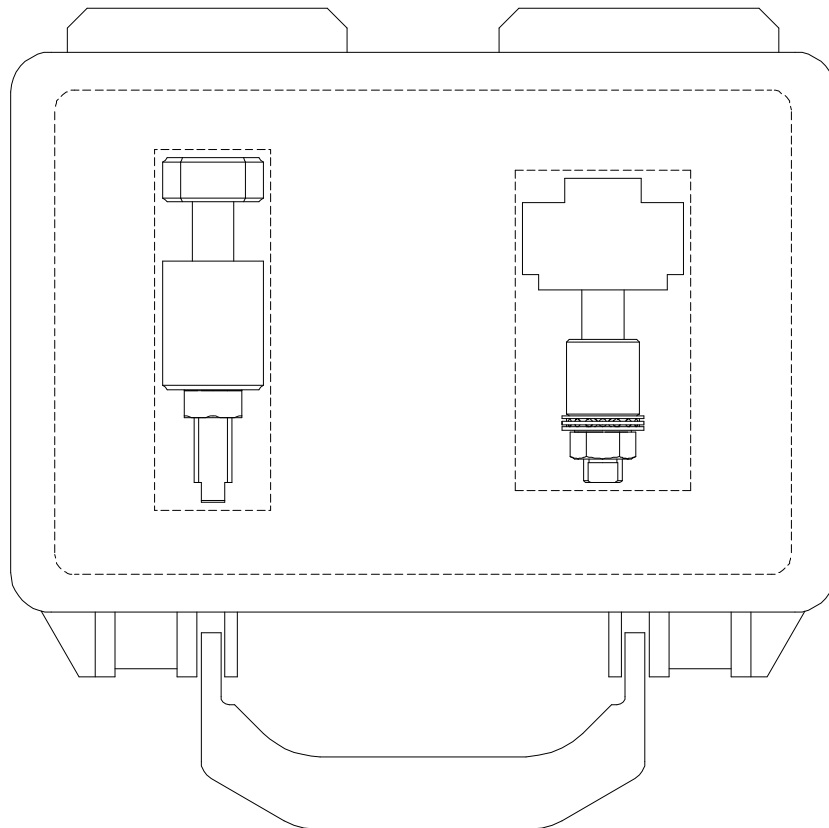

	GSE & TOOL USE AND MAINTENANCE MANUAL	Manual number: MAN-3G6305G29431 REV. A
		Pag. 2 of 17

REVISION HISTORY

REV	CHANGE DESCRIPTION	DATE
A	First issue	18/11/2021

SUMMARY

SUMMARY	3
LIST OF TABLE	4
LIST OF FIGURE	4
1. SCOPE	5
1.1. APPLICABILITY	5
1.2. OBJECT	5
1.3. WARNING AND SAFETY INSTRUCTIONS	5
2. DOCUMENTS	6
2.1. APPLICABLE DOCUMENTS	6
2.2. ACRONYMS USED	6
3. DESCRIPTION	7
4. TOP ASSEMBLY DRAWINGS	7
5. IDENTIFICATION	7
6. OVERALL DIMENSIONS	8
7. WEIGHT	8
8. MAIN PARTS	9
9. MAIN FEATURES DESCRIPTION	9
10. WARNING AND SAFETY NOTES	10
10.1. WARNING NOTE	10
10.2. SAFETY NOTES	11
11. STORAGE	12
11.1. LUBRICATION BEFORE STORAGE	12
11.2. STORAGE CONFIGURATION	12
12. MAINTENANCE	12
12.1. CLEANING	12
12.1.1. SPECIAL TOOLS, FIXTURE AND EQUIPMENT	12
12.1.2. PART REQUIREMENTS	12
12.1.3. MANUAL CLEANING	12
12.2. CHECKS	13
12.2.1. SPECIAL TOOLS, FIXTURE AND EQUIPMENT	13
12.2.2. VISUAL EXAMINATION	13
12.2.3. PERIODICAL CHECKS	14
12.2.4. DIMENSIONAL CHECKS	14
12.2.5. SPECIAL CHECKS SUMMARY	14
12.3. REPLACEMENT	14
12.3.1. REPLACEMENT PROCEDURES	14

	GSE & TOOL USE AND MAINTENANCE MANUAL	Manual number: MAN-3G6305G29431 REV. A
		Pag. 4 of 17

13.	CALIBRATION	14
14.	SHELF LIFE	14
15.	SPARE PARTS	15
16.	CE MARKING.....	16
	ANNEX A.....	17

LIST OF TABLE

Table 1 – Warning Instruction	5
Table 2 – Applicable Documents.....	6
Table 3 – Warning Note.....	10
Table 4 – Visual Check.....	13
Table 5 – Spare Parts.....	15

LIST OF FIGURE

<i>Figure 1 – Tool kit, gimbal / torque tube bushings repl. for MGB equipped with AGB system</i>	<i>7</i>
<i>Figure 2 – LHD Identification tag with P/N</i>	<i>7</i>
<i>Figure 3 – Main Parts</i>	<i>9</i>
<i>Figure 4 – Safety Notes.....</i>	<i>11</i>
<i>Figure 5 – Spare Parts</i>	<i>15</i>

1. SCOPE

1.1. APPLICABILITY

The contents of this document are meant to provide information on the P/N 3G6305G29431 TOOL KIT, GIMBAL / TORQUE TUBE BUSHINGS REPL. FOR MGB EQUIPPED WITH AGB SYSTEM

1.2. OBJECT

The object of this document is to describe the AGE and its components, its main features and it will also provide all needed maintenance requirements to keep in service the P/N 3G6305G29431 TOOL KIT, GIMBAL / TORQUE TUBE BUSHINGS REPL. FOR MGB EQUIPPED WITH AGB SYSTEM

1.3. WARNING AND SAFETY INSTRUCTIONS

A number of symbols are used throughout this document to indicate information to which the user should pay attention to. These are indicated below along with the specific meaning.



 Warning	...Indicates a danger that might arise from a product and might result in severe injuries or even death, if no precautions are taken.
 Caution	... Indicates a potentially dangerous situation, which might result injury or damage to the equipment.
 Notice	...Indicates a note providing information to help the reader during the procedure.

Table 1 – Warning Instruction

	GSE & TOOL USE AND MAINTENANCE MANUAL	Manual number: MAN-3G6305G29431 REV. A
		Pag. 6 of 17

2. DOCUMENTS

2.1. APPLICABLE DOCUMENTS

The following table lists the applicable documents

REF	REFERENCE OF DOCUMENT	TITLE
N.A.	N.A.	N.A.

Table 2 – Applicable Documents

2.2. ACRONYMS USED

The main acronyms used in this document are listed below:

LHD	Leonardo Helicopter Division
HC	Helicopter
P/N	Part Number
S/N	Serial Number
N.A.	Not Applicable
MGB	Main Gear Box
AGB	Auxiliary Gear Box

3. DESCRIPTION

This tool kit is used to repair the MGB gimbal assy without removing the component from the aircraft. It is also used off aircraft at the organization and intermediate level during the maintenance repair and overhaul activities.

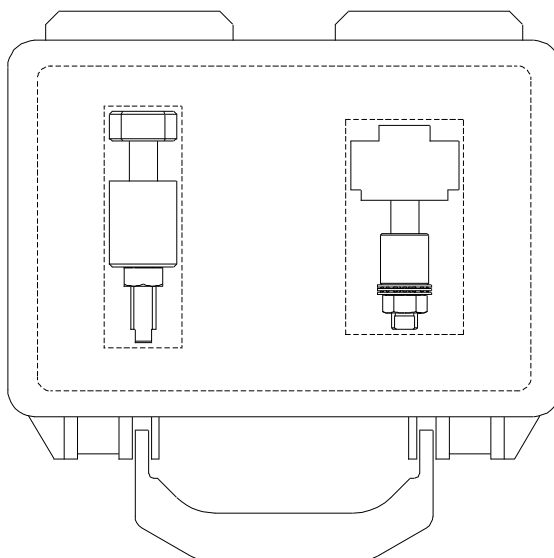

3G6305G29431_1

Figure 1 – Tool kit, gimbal / torque tube bushings repl. for MGB equipped with AGB system

4. TOP ASSEMBLY DRAWINGS

Refer to P/N 3G6305G29431 TOOL KIT, GIMBAL / TORQUE TUBE BUSHINGS REPL. FOR MGB EQUIPPED WITH AGB SYSTEM.

5. IDENTIFICATION

The tool identification P/N is marked on the LHD identification tag.

<h1 style="margin: 0;">AGUSTA</h1>			
P/N	3 G 6 3 0 5 G 2 9 4 3 1		
MFG. DATE		MOD	
C. I.		GRWT Kg.	

Figure 2 – LHD Identification tag with P/N



GSE & TOOL USE AND MAINTENANCE MANUAL

Manual number:
MAN-3G6305G29431
REV. A

Pag. 8 of 17

6. OVERALL DIMENSIONS

- Length: 214 mm
- Width: 172 mm
- Height: 98 mm

7. WEIGHT

- Total Weight: 1 kg

8. MAIN PARTS

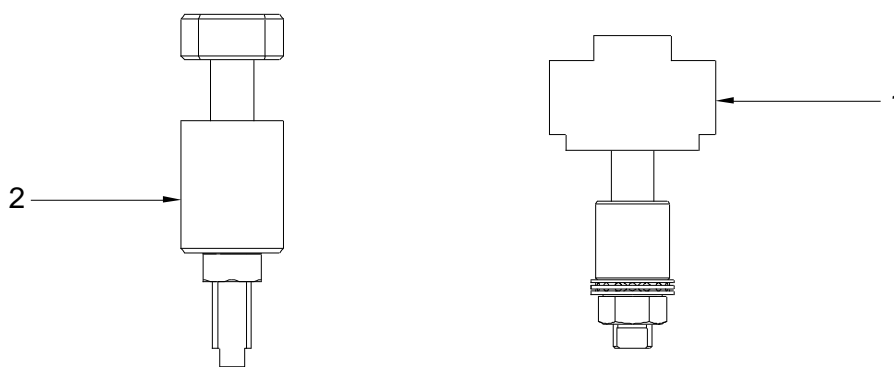

3G6305G29431_2

Figure 3 – Main Parts

The main parts of the TOOL KIT, GIMBAL / TORQUE TUBE BUSHINGS REPL. FOR MGB EQUIPPED WITH AGB SYSTEM are:

1. Tool, gimbal/torque tube bushings removal
2. Tool, gimbal/torque tube bushings installation

9. MAIN FEATURES DESCRIPTION

The kit supplied in a suitable transportation box, is composed of the following tools:

- The bushings removal tool (1, [Figure 3](#)), used to remove the two bushings from the gimbal support assy installed on the pinion input assy, part of the module input assy installed on MGB at the organization and intermediate level, without to remove the component from the helicopter. It is also used to perform the same activity to the torque tube assy;
- The bushings installation tool (2), used to install the two bushings into theirs housings on the gimbal support assy installed on the pinion input assy, part of the module input assy installed on MGB at the organization level. It is necessary to center the bushing with its housing during the installation when the components are installed. It is also used to perform the same activity to the torque tube assy.

10. WARNING AND SAFETY NOTES

10.1. WARNING NOTE







 Warning	<p>Use this equipment only for the purpose that it is designed for. Any other use can result in injury or serious material damage to the components.</p>
 Caution	
 Notice	<p>The Manual can never integrally replace the adequate competence of the user.</p>
 Warning	<p>Before and after each use of the equipment is necessary to perform the checks required. Do not operate with a tool damaged or partially completed, or partially assembled.</p>
 Caution	
 Notice	<p>This Manual provides guidelines and instructions of the equipment that are in addition to - but are not intended to replace or modify but only to integrate - any general or specific rule, regulation, decree or law that is in force in the place where the equipment is in use.</p>

Table 3 – Warning Note

10.2. SAFETY NOTES

Remember to wear protective overalls, safety shoes, protective gloves and glasses during all operational and maintenance phases.



Figure 4 – Safety Notes

11. STORAGE

The Tool shall be properly stored to provide protection from external weather conditions, damage and dirty particles.

The Kit shall be stored in the dedicated transportation box (part of the Kit).

Ensure that the tool parts are clean before storage.

11.1. LUBRICATION BEFORE STORAGE

Apply the Grease (MIL-PRF-23827) on all threaded parts before tool storage.

11.2. STORAGE CONFIGURATION

The tool has no particular storage configuration.

12. MAINTENANCE

NOTE: Correct regular maintenance allows preventing most faults and safeguards of tool performance in time, thereby making it last longer.

Every year carry out regular maintenance on a regular basis as detailed in this manual.

NOTE: Inspection intervals for tool parts placed inside in ready storage is 12 months.

12.1. CLEANING

Before inspection and after each use, carry out the cleaning of the tool components.

12.1.1. SPECIAL TOOLS, FIXTURE AND EQUIPMENT

No special tools, fixture and equipment are required for cleaning.

12.1.2. PART REQUIREMENTS

The parts to clean should be free from the moisture, emulsified water, soaps and metal shavings that can develop of corrosive acids.

They must also be free from wide grease and / or slosh deposits.

12.1.3. MANUAL CLEANING

- A. Clean thoroughly all metal surfaces with a clean lint-free cloth (Local supply) moistened with Cleaning Solvent (MIL-PRF-680C, Type II) to do general spot cleaning of large groups areas. For nylon or Teflon surfaces, the use of a biodegradable, water dilutable cleaning compound (MIL-PRF-87937 D, Type II) is required.
- B. Repeat the cleaning process again by means another clean lint-free cloth (Local supply).
- C. Drying.
 - Verify that the solvent should not be trapped in the cavity. Normally, the solvent evaporates at room temperature in a satisfactory manner.

12.2. CHECKS

Before and after each use or at least every year, carry out the check of kit component.

Before each use ensure that the manual is available to the operator, in the event of loss, request a copy to Leonardo Helicopters Division.

The Tool kit shall be submitted to following checks to guarantee the functionality.

All required checks shall be registered on CHECK RECORDS Table. Ref. *TLC_Table 1*

After each use of tool ensure to have registered the number of uses on HISTORICAL USES RECORD Table. Ref. *TLC_Table 2*

The Tool Log Card template contained in the Annex A of this manual can be replaced with any other log card template in use in the plant where the equipment is in use.

12.2.1. SPECIAL TOOLS, FIXTURE AND EQUIPMENT

No special tools, fixture and equipment are required for the checks.

12.2.2. VISUAL EXAMINATION

NOTE: Replace the parts that do not obey the inspection requirements.

Restore the marking of the parts that results damaged or not readable.

All required visual checks are listed on Table 4

PERIODICITY	CHECK TYPE	COMPONENTS	
BEFORE AND AFTER EVERY USE	VISUAL EXAMINATION	Evidence of impact;	All
		Crushing or stripping	All
		Cracks	All
		Dents	All
		Wear	All
		Distortions	All
		Corrosion	All
		Loose or defective attaching parts (warning flag)	All
		Unsticking of parts	Item 4, Nameplate, Figure 5 , page 15 Item 7, Plate, Figure 5 , page 15
		Damage to the threads	All
		Marking	All
		Damage to the pins and to the shell	N.A.
		Damage to the insulation sleeves and wires	N.A.

Table 4 – Visual Check



GSE & TOOL USE AND MAINTENANCE MANUAL

Manual number:
MAN-3G6305G29431
REV. A

Pag. 14 of 17

12.2.3. PERIODICAL CHECKS

Not Applicable.

12.2.4. DIMENSIONAL CHECKS

Not Applicable.

12.2.5. SPECIAL CHECKS SUMMARY

Not Applicable.

12.3. REPLACEMENT

All the parts for which it is allowed the components replacement are listed in Paragraph 15.

12.3.1. REPLACEMENT PROCEDURES

The replacement of parts of the kit does not require specific procedures.

13. CALIBRATION

No Calibration is required.

14. SHELF LIFE

Not Applicable.

15. SPARE PARTS

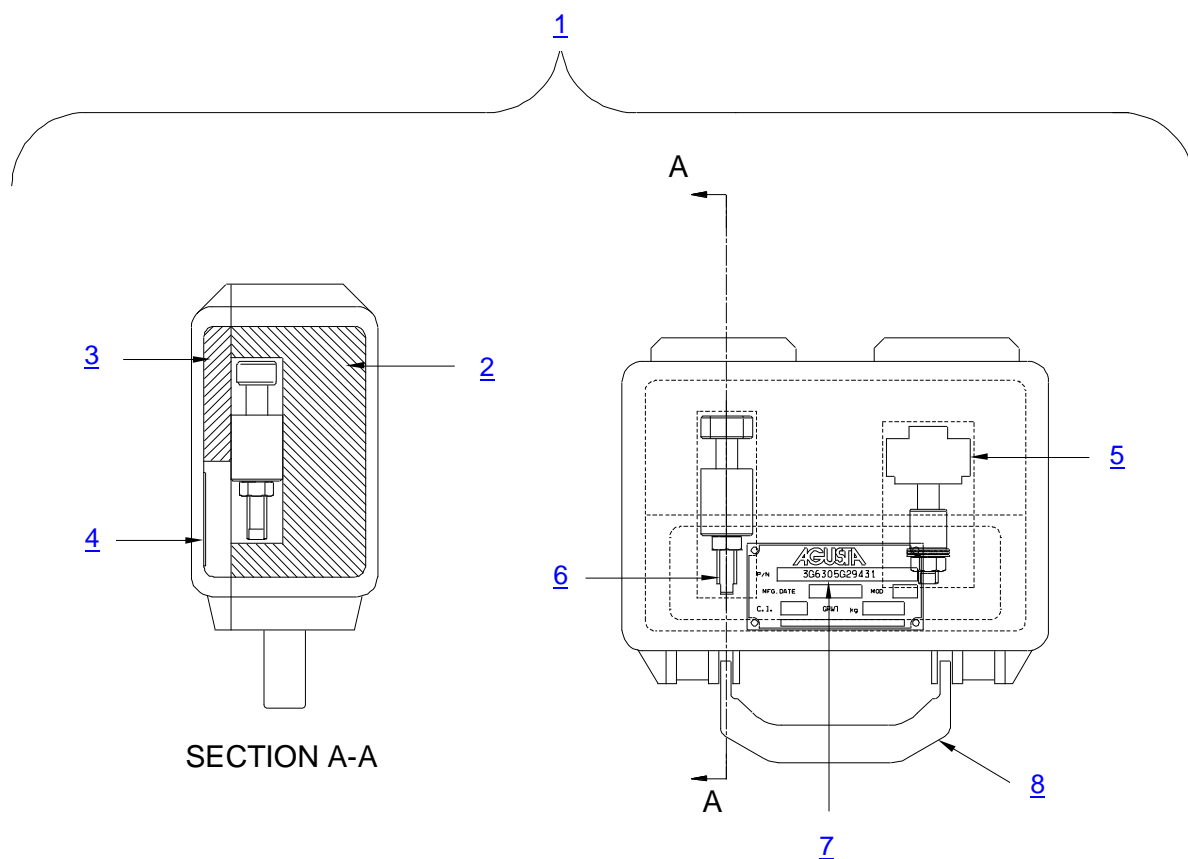

3G6305G29431_3

Figure 5 – Spare Parts

ITEM	P/N	DESCRIPTION	Q.TY
1	3G6305G29431	TOOL KIT, GIMBAL/TORQUE TUBE BUSH. REPL	REF.
2	3G6305G29551	FOAM	1
3	3G6305G29651	FOAM	1
4	3G6305G29751	NAMEPLATE	1
5	3G6305G29831	TOOL, GIMBAL/TORQUE TUBE BUSHINGS REM	1
6	3G6305G30231	TOOL, GIMBAL/TORQUE TUBE BUSHINGS INSTL	1
7	A304A001A1	PLATE, IDENTIFICATION	1
8	1120	CASE PROTECTOR	1

Table 5 – Spare Parts

	GSE & TOOL USE AND MAINTENANCE MANUAL	Manual number: MAN-3G6305G29431 REV. A <hr/> Pag. 16 of 17
---	--	---

16. CE MARKING

No CE marking is required for the P/N 3G6305G29431 TOOL KIT, GIMBAL / TORQUE TUBE BUSHINGS REPL. FOR MGB EQUIPPED WITH AGB SYSTEM.



GSE & TOOL
USE AND MAINTENANCE MANUAL

Manual number:
MAN-3G6305G29431
REV. A

Pag. 17 of 17

ANNEX A

TOOL LOG CARD



TOOL LOG CARD

ISSUE -/
Pag. 1 of 3

TOOL KIT P/N: [1]	TOOL KIT DESCRIPTION: [2]	TOOL KIT S/N: [3]
TOOL P/N: [4]	TOOL S/N: [5]	REMARKS: [6]

Section 1: CHECKS RECORD

[7] N° check	[8] DATE	[9] P/N TO CHECK	[10] CHECK	[11] FREQUENCY	[12] RESULT	[13] NOTE	CERTIFICATION [14]
							STAMP & SIGNATURE [15]
1							
2							
3							
4							
5							
6							
7							
8							
9							
10							
FINAL ACCEPTANCE [16]							
STAMP & SIGNATURE [17]						DATE [18]	

TLC_Table 1



TOOL LOG CARD

ISSUE -/-
Pag. 2 of 3

TOOL KIT P/N: [1]	TOOL KIT DESCRIPTION: [2]	TOOL KIT S/N: [3]
TOOL P/N: [4]	TOOL S/N: [5]	REMARKS: [6]

Section 2: HISTORICAL USES RECORD

[19] N°USE	[8] DATE	[6] NOTE	[13] CERTIFICATION	[19] N°USE	[8] DATE	[6] NOTE	[13] CERTIFICATION
			[14] STAMP & SIGNATURE				[14] STAMP & SIGNATURE
1				11			
2				12			
3				13			
4				14			
5				15			
6				16			
7				17			
8				18			
9				19			
10				20			

TLC_Table 2

LOG CARD FILLING INSTRUCTIONS

FIELD #	HEADER	NOTE
1	Part number of the tool Kit	
2	Tool Kit denomination	
3	Serial Number of the tool Kit	
4	Part Number of the tool (part of kit)	
5	Serial Number of the tool (if applicable)	
6	Indicate any details of the use	
7	Sequential number of check performed	
8	Date of the activity	
9	PN of tool or component (part of tool) checked/affected by issue	
10	Typology or description of checks /issue	
11	Check frequency	
12	Check result	
13	Check remarks	
14	Performance certification	
15	Stamp and signature of the personnel which performs the check	
16	Section related to the final approval	
17	Stamp and signature of the personnel which performs the final approval	
18	Date on which the final check was made	
19	Sequential number of performed used of the tool	