

GSE & TOOL MANUAL

TITLE

**RETRACTOR ASSY, M/R PITCH CONTROL LEVER INST
P/N 3G6205G06131**

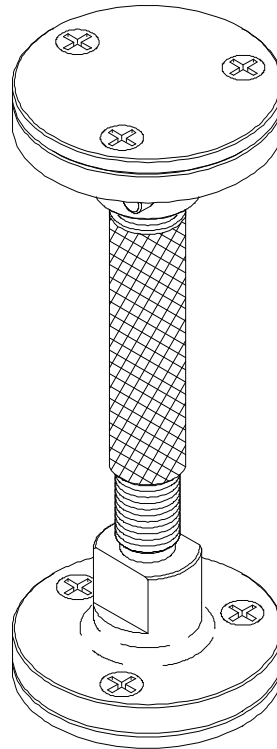

	GSE & TOOL USE AND MAINTENANCE MANUAL	Manual number: MAN-3G6205G06131 REV. A Pag. 2 of 17
---	--	--

REVISION HISTORY

REV	CHANGE DESCRIPTION	DATE
A	First issue	11/11/2021

SUMMARY

SUMMARY	3
LIST OF TABLE	4
LIST OF FIGURE	4
1. SCOPE	5
1.1. APPLICABILITY	5
1.2. OBJECT	5
1.3. WARNING AND SAFETY INSTRUCTIONS	5
2. DOCUMENTS	6
2.1. APPLICABLE DOCUMENTS	6
2.2. ACRONYMS USED	6
3. DESCRIPTION	7
4. TOP ASSEMBLY DRAWINGS	7
5. IDENTIFICATION	7
6. OVERALL DIMENSIONS	8
7. WEIGHT	8
8. MAIN PARTS	9
9. MAIN FEATURES DESCRIPTION	9
10. WARNING AND SAFETY NOTES	10
10.1. WARNING NOTE	10
10.2. SAFETY NOTES	11
11. STORAGE	12
11.1. LUBRICATION BEFORE STORAGE	12
11.2. STORAGE CONFIGURATION	12
12. MAINTENANCE	12
12.1. CLEANING	12
12.1.1. SPECIAL TOOLS, FIXTURE AND EQUIPMENT	12
12.1.2. PART REQUIREMENTS	12
12.1.3. MANUAL CLEANING	12
12.2. CHECKS	13
12.2.1. SPECIAL TOOLS, FIXTURE AND EQUIPMENT	13
12.2.2. VISUAL EXAMINATION	13
12.2.3. PERIODICAL CHECKS	14
12.2.4. DIMENSIONAL CHECKS	14
12.2.5. SPECIAL CHECKS SUMMARY	14
12.3. REPLACEMENT	14
12.3.1. REPLACEMENT PROCEDURES	14

	GSE & TOOL USE AND MAINTENANCE MANUAL	Manual number: MAN-3G6205G06131 REV. A
		Pag. 4 of 17

13.	CALIBRATION	14
14.	SHELF LIFE	14
15.	SPARE PARTS	15
16.	CE MARKING.....	16
	ANNEX A.....	17

LIST OF TABLE

Table 1 – Warning Instruction	5
Table 2 – Applicable Documents.....	6
Table 3 – Warning Note.....	10
Table 4 – Visual Check.....	13
Table 5 – Spare Parts.....	15

LIST OF FIGURE

<i>Figure 1 – Tool, retractor assy, M/R pitch control lever inst.....</i>	<i>7</i>
<i>Figure 2 – P/N marking area</i>	<i>7</i>
<i>Figure 3 – Main Parts</i>	<i>9</i>
<i>Figure 4 – Safety Notes.....</i>	<i>11</i>
<i>Figure 5 – Spare Parts</i>	<i>15</i>

1. SCOPE

1.1. APPLICABILITY

The contents of this document are meant to provide information on the P/N 3G6205G06131 RETRACTOR ASSY, M/R PITCH CONTROL LEVER INST.

1.2. OBJECT

The object of this document is to describe the AGE and its components, its main features and it will also provide all needed maintenance requirements to keep in service the P/N 3G6205G06131 RETRACTOR ASSY, M/R PITCH CONTROL LEVER INST.

1.3. WARNING AND SAFETY INSTRUCTIONS

A number of symbols are used throughout this document to indicate information to which the user should pay attention to. These are indicated below along with the specific meaning.



 Warning	...Indicates a danger that might arise from a product and might result in severe injuries or even death, if no precautions are taken.
 Caution	... Indicates a potentially dangerous situation, which might result injury or damage to the equipment.
 Notice	...Indicates a note providing information to help the reader during the procedure.

Table 1 – Warning Instruction

	GSE & TOOL USE AND MAINTENANCE MANUAL	Manual number: MAN-3G6205G06131 REV. A
		Pag. 6 of 17

2. DOCUMENTS

2.1. APPLICABLE DOCUMENTS

The following table lists the applicable documents

REF	REFERENCE OF DOCUMENT	TITLE
N.A.	N.A.	N.A.

Table 2 – Applicable Documents

2.2. ACRONYMS USED

The main acronyms used in this document are listed below:

LHD	Leonardo Helicopter Division
HC	Helicopter
P/N	Part Number
S/N	Serial Number
N.A.	Not Applicable
M/R	Main Rotor

3. DESCRIPTION

The function of this tool is to open wide the tension link assy to facilitate the installation of the pitch control lever.

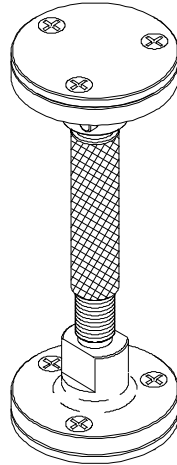

3G6205G06131_1

Figure 1 – Tool, retractor assy, M/R pitch control lever inst

4. TOP ASSEMBLY DRAWINGS

Refer to P/N 3G6205G06131 RETRACTOR ASSY, M/R PITCH CONTROL LEVER INST.

5. IDENTIFICATION

The tool identification P/N is marked on the tool.

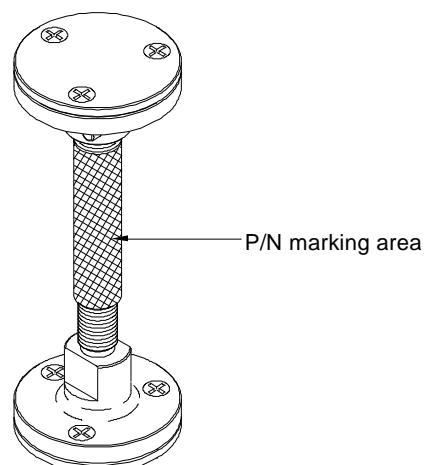

Figure 2 – P/N marking area



GSE & TOOL USE AND MAINTENANCE MANUAL

Manual number:
MAN-3G6205G06131
REV. A

Pag. 8 of 17

6. OVERALL DIMENSIONS

- Length: 60 mm
- Width: 60 mm
- Height: 125 mm

7. WEIGHT

- Total Weight: 1,5 kg

8. MAIN PARTS

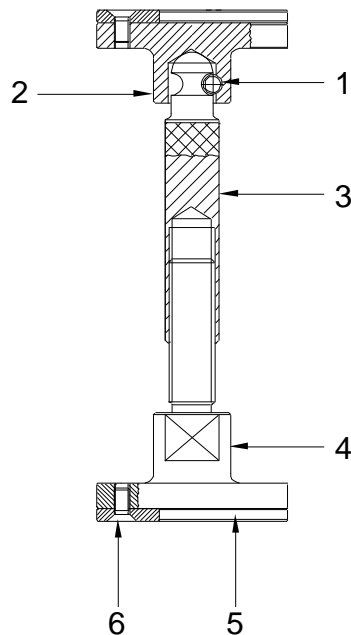

3G6205G06131_2

Figure 3 – Main Parts

The main parts of the RETRACTOR ASSY, M/R PITCH CONTROL LEVER INST are:

1. Pin
2. Pad
3. Sleeve
4. Pad
5. Shim
6. Screw

9. MAIN FEATURES DESCRIPTION

This tool consists of a sleeve on which are applied a two pads, a pin and a two shims fixed with three screws.

10. WARNING AND SAFETY NOTES

10.1. WARNING NOTE







 Warning	<p>Use this equipment only for the purpose that it is designed for. Any other use can result in injury or serious material damage to the components.</p>
 Caution	
 Notice	<p>The Manual can never integrally replace the adequate competence of the user.</p>
 Warning	<p>Before and after each use of the equipment is necessary to perform the checks required. Do not operate with a tool damaged or partially completed, or partially assembled.</p>
 Caution	
 Notice	<p>This Manual provides guidelines and instructions of the equipment that are in addition to - but are not intended to replace or modify but only to integrate - any general or specific rule, regulation, decree or law that is in force in the place where the equipment is in use.</p>

Table 3 – Warning Note

10.2. SAFETY NOTES

Remember to wear protective overalls, safety shoes, protective gloves and glasses during all operational and maintenance phases.



Figure 4 – Safety Notes

	GSE & TOOL USE AND MAINTENANCE MANUAL	Manual number: MAN-3G6205G06131 REV. A
		Pag. 12 of 17

11. STORAGE

The Tool shall be properly stored to provide protection from external weather conditions, damage and dirty particles.

Ensure that the tool parts are clean before storage.

11.1. LUBRICATION BEFORE STORAGE

N.A.

11.2. STORAGE CONFIGURATION

The tool has no particular storage configuration.

12. MAINTENANCE

NOTE: Correct regular maintenance allows preventing most faults and safeguards of tool performance in time, thereby making it last longer.

Every year carry out regular maintenance on a regular basis as detailed in this manual.

NOTE: Inspection intervals for tool parts placed inside in ready storage is 12 months.

12.1. CLEANING

Before inspection and after each use, carry out the cleaning of the tool components.

12.1.1. SPECIAL TOOLS, FIXTURE AND EQUIPMENT

No special tools, fixture and equipment are required for cleaning.

12.1.2. PART REQUIREMENTS

The parts to clean should be free from the moisture, emulsified water, soaps and metal shavings that can develop of corrosive acids.

They must also be free from wide grease and / or slosh deposits.

12.1.3. MANUAL CLEANING

- A. Clean thoroughly all metal surfaces with a clean lint-free cloth (Local supply) moistened with Cleaning Solvent (MIL-PRF-680C, Type II) to do general spot cleaning of large groups areas. For nylon or Teflon surfaces, the use of a biodegradable, water dilutable cleaning compound (MIL-PRF-87937 D, Type II) is required.
- B. Repeat the cleaning process again by means another clean lint-free cloth (Local supply).
- C. Drying.
 - Verify that the solvent should not be trapped in the cavity. Normally, the solvent evaporates at room temperature in a satisfactory manner.

12.2. CHECKS

Before and after each use or at least every year, carry out the check of kit component.

Before each use ensure that the manual is available to the operator, in the event of loss, request a copy to Leonardo Helicopters Division.

The Tool kit shall be submitted to following checks to guarantee the functionality.

All required checks shall be registered on CHECK RECORDS Table. Ref. *TLC_Table 1*

After each use of tool ensure to have registered the number of uses on HISTORICAL USES RECORD Table. Ref. *TLC_Table 2*

The Tool Log Card template contained in the Annex A of this manual can be replaced with any other log card template in use in the plant where the equipment is in use.

12.2.1. SPECIAL TOOLS, FIXTURE AND EQUIPMENT

No special tools, fixture and equipment are required for the checks.

12.2.2. VISUAL EXAMINATION

NOTE: Replace the parts that do not obey the inspection requirements.

Restore the marking of the parts that results damaged or not readable.

All required visual checks are listed on Table 4

PERIODICITY	CHECK TYPE	COMPONENTS	
BEFORE AND AFTER EVERY USE	VISUAL EXAMINATION	Evidence of impact;	All
	Crushing or stripping	All	
	Cracks	All	
	Dents	All	
	Wear	All	
	Distortions	All	
	Corrosion	All	
	Loose or defective attaching parts (warning flag)	All	
	Unsticking of parts	N.A.	
	Damage to the threads	All	
	Marking	All	
	Damage to the pins and to the shell	N.A.	
	Damage to the insulation sleeves and wires	N.A.	

Table 4 – Visual Check



GSE & TOOL USE AND MAINTENANCE MANUAL

Manual number:
MAN-3G6205G06131
REV. A

Pag. 14 of 17

12.2.3. PERIODICAL CHECKS

Not Applicable.

12.2.4. DIMENSIONAL CHECKS

Not Applicable.

12.2.5. SPECIAL CHECKS SUMMARY

Not Applicable.

12.3. REPLACEMENT

All the parts for which it is allowed the components replacement are listed in Paragraph 15.

12.3.1. REPLACEMENT PROCEDURES

The replacement of parts of the kit does not require specific procedures.

13. CALIBRATION

No Calibration is required.

14. SHELF LIFE

Not Applicable.

15. SPARE PARTS

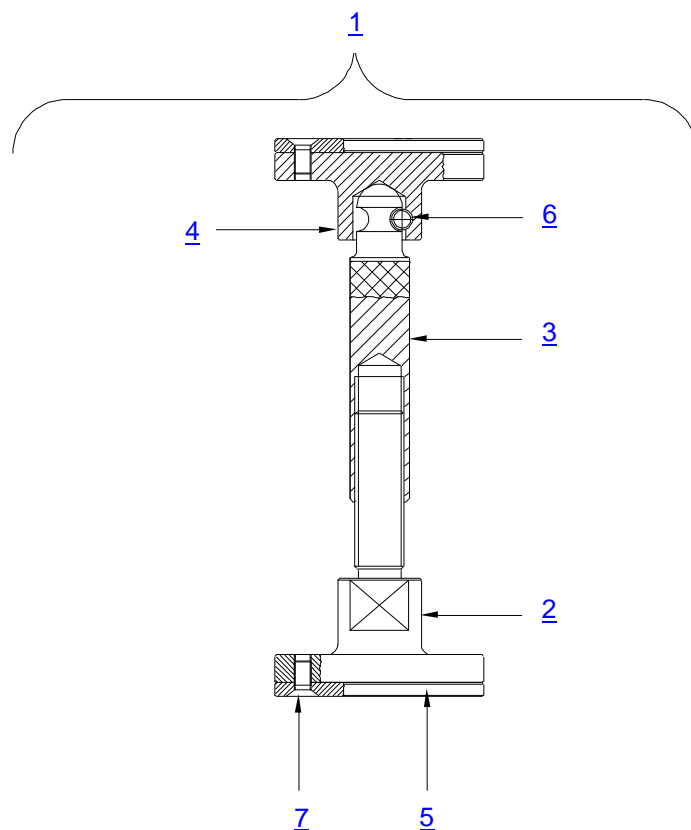

3G6205G06131_3

Figure 5 – Spare Parts

ITEM	P/N	DESCRIPTION	Q.TY
1	3G6205G06131	RETRACTOR, M/R PITCH CONTROL LEVER INST	REF.
2	3G6205G07551	REACTION PAD	1
3	3G6205G07651	SLEEVE	1
4	3G6205G07751	THRUST PAD	1
5	3G6205G08551	SHIM	2
6	MS171650	PIN, SPRING	1
7	MS24694-S48	SCREW, MACHINE	6

Table 5 – Spare Parts

	GSE & TOOL USE AND MAINTENANCE MANUAL	Manual number: MAN-3G6205G06131 REV. A
		Pag. 16 of 17

16. CE MARKING

No CE marking is required for the P/N 3G6205G06131 RETRACTOR ASSY, M/R PITCH CONTROL LEVER INST



GSE & TOOL
USE AND MAINTENANCE MANUAL

Manual number:
MAN-3G6205G06131
REV. A

Pag. 17 of 17

ANNEX A

TOOL LOG CARD



TOOL LOG CARD

ISSUE -/
Pag. 1 of 3

TOOL KIT P/N: [1]	TOOL KIT DESCRIPTION: [2]	TOOL KIT S/N: [3]
TOOL P/N: [4]	TOOL S/N: [5]	REMARKS: [6]

Section 1: CHECKS RECORD

[7] N° check	[8] DATE	[9] P/N TO CHECK	[10] CHECK	[11] FREQUENCY	[12] RESULT	[13] NOTE	CERTIFICATION [14]
							STAMP & SIGNATURE [15]
1							
2							
3							
4							
5							
6							
7							
8							
9							
10							
FINAL ACCEPTANCE [16]							
STAMP & SIGNATURE [17]						DATE [18]	

TLC_Table 1



TOOL LOG CARD

ISSUE -/-
Pag. 2 of 3

TOOL KIT P/N: [1]	TOOL KIT DESCRIPTION: [2]	TOOL KIT S/N: [3]
TOOL P/N: [4]	TOOL S/N: [5]	REMARKS: [6]

Section 2: HISTORICAL USES RECORD

[19] N°USE	[8] DATE	[6] NOTE	[13] CERTIFICATION	[19] N°USE	[8] DATE	[6] NOTE	[13] CERTIFICATION
			[14] STAMP & SIGNATURE				[14] STAMP & SIGNATURE
1				11			
2				12			
3				13			
4				14			
5				15			
6				16			
7				17			
8				18			
9				19			
10				20			

TLC_Table 2

LOG CARD FILLING INSTRUCTIONS

FIELD #	HEADER	NOTE
1	Part number of the tool Kit	
2	Tool Kit denomination	
3	Serial Number of the tool Kit	
4	Part Number of the tool (part of kit)	
5	Serial Number of the tool (if applicable)	
6	Indicate any details of the use	
7	Sequential number of check performed	
8	Date of the activity	
9	PN of tool or component (part of tool) checked/affected by issue	
10	Typology or description of checks /issue	
11	Check frequency	
12	Check result	
13	Check remarks	
14	Performance certification	
15	Stamp and signature of the personnel which performs the check	
16	Section related to the final approval	
17	Stamp and signature of the personnel which performs the final approval	
18	Date on which the final check was made	
19	Sequential number of performed used of the tool	