



**GSE & TOOL
USE AND MAINTENANCE MANUAL**

Manual number:
**MAN-3G2805G00131
REV. A**

Pag. 1 of 17

GSE & TOOL MANUAL

TITLE

**TOOL, BOOSTER PUMP CARTRIDGE REMOVAL
P/N 3G2805G00131**

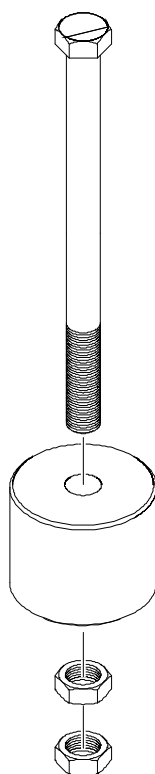

| | | |
|---|--|--|
|  | GSE & TOOL USE AND MAINTENANCE MANUAL | Manual number: MAN-3G2805G00131 REV. A |
| | | Pag. 2 of 17 |

REVISION HISTORY

| REV | CHANGE DESCRIPTION | DATE |
|-----|--------------------|------------|
| A | First issue | 12/10/2021 |
| | | |

SUMMARY

| | |
|--|----|
| SUMMARY | 3 |
| LIST OF TABLE | 4 |
| LIST OF FIGURE | 4 |
| 1. SCOPE | 5 |
| 1.1. APPLICABILITY | 5 |
| 1.2. OBJECT | 5 |
| 1.3. WARNING AND SAFETY INSTRUCTIONS | 5 |
| 2. DOCUMENTS | 6 |
| 2.1. APPLICABLE DOCUMENTS | 6 |
| 2.2. ACRONYMS USED | 6 |
| 3. DESCRIPTION | 7 |
| 4. TOP ASSEMBLY DRAWINGS | 7 |
| 5. IDENTIFICATION | 7 |
| 6. OVERALL DIMENSIONS | 8 |
| 7. WEIGHT | 8 |
| 8. MAIN PARTS | 9 |
| 9. MAIN FEATURES DESCRIPTION | 9 |
| 10. WARNING AND SAFETY NOTES | 10 |
| 10.1. WARNING NOTE | 10 |
| 10.2. SAFETY NOTES | 11 |
| 11. STORAGE | 12 |
| 11.1. LUBRICATION BEFORE STORAGE | 12 |
| 11.2. STORAGE CONFIGURATION | 12 |
| 12. MAINTENANCE | 12 |
| 12.1. CLEANING | 12 |
| 12.1.1. SPECIAL TOOLS, FIXTURE AND EQUIPMENT | 12 |
| 12.1.2. PART REQUIREMENTS | 12 |
| 12.1.3. MANUAL CLEANING | 12 |
| 12.2. CHECKS | 13 |
| 12.2.1. SPECIAL TOOLS, FIXTURE AND EQUIPMENT | 13 |
| 12.2.2. VISUAL EXAMINATION | 13 |
| 12.2.3. PERIODICAL CHECKS | 14 |
| 12.2.4. DIMENSIONAL CHECKS | 14 |
| 12.2.5. SPECIAL CHECKS SUMMARY | 14 |
| 12.3. REPLACEMENT | 14 |
| 12.3.1. REPLACEMENT PROCEDURES | 14 |

| | | |
|---|--|--|
|  | GSE & TOOL USE AND MAINTENANCE MANUAL | Manual number: MAN-3G2805G00131 REV. A |
| | | Pag. 4 of 17 |

| | | |
|-----|-------------------|----|
| 13. | CALIBRATION | 14 |
| 14. | SHELF LIFE | 14 |
| 15. | SPARE PARTS | 15 |
| 16. | CE MARKING..... | 16 |
| | ANNEX A..... | 17 |

LIST OF TABLE

| | |
|-------------------------------------|-----------|
| Table 1 – Warning Instruction | 5 |
| Table 2 – Applicable Documents..... | 6 |
| Table 3 – Warning Note..... | 10 |
| Table 4 – Visual Check..... | 13 |
| <i>Table 5 – Spare Parts.....</i> | <i>15</i> |

LIST OF FIGURE

| | |
|--|-----------|
| <i>Figure 1 – Tool, booster pump cartridge removal</i> | <i>7</i> |
| <i>Figure 2 – P/N marking area</i> | <i>7</i> |
| <i>Figure 3 – Main Parts</i> | <i>9</i> |
| <i>Figure 4 – Safety Notes.....</i> | <i>11</i> |
| <i>Figure 5 – Spare Parts</i> | <i>15</i> |

1. SCOPE

1.1. APPLICABILITY

The contents of this document are meant to provide information on the P/N 3G2805G00131 TOOL, BOOSTER PUMP CARTRIDGE REMOVAL.

1.2. OBJECT

The object of this document is to describe the AGE and its components, its main features and it will also provide all needed maintenance requirements to keep in service the P/N 3G2805G00131 TOOL, BOOSTER PUMP CARTRIDGE REMOVAL.

1.3. WARNING AND SAFETY INSTRUCTIONS

A number of symbols are used throughout this document to indicate information to which the user should pay attention to. These are indicated below along with the specific meaning.



| | |
|---|---|
|  Warning | ...Indicates a danger that might arise from a product and might result in severe injuries or even death, if no precautions are taken. |
|  Caution | ... Indicates a potentially dangerous situation, which might result injury or damage to the equipment. |
|  Notice | ...Indicates a note providing information to help the reader during the procedure. |

Table 1 – Warning Instruction

| | | |
|---|--|--|
|  | GSE & TOOL USE AND MAINTENANCE MANUAL | Manual number: MAN-3G2805G00131 REV. A |
| | | Pag. 6 of 17 |

2. DOCUMENTS

2.1. APPLICABLE DOCUMENTS

The following table lists the applicable documents

| REF | REFERENCE OF DOCUMENT | TITLE |
|------|-----------------------|-------|
| N.A. | N.A. | N.A. |

Table 2 – Applicable Documents

2.2. ACRONYMS USED

The main acronyms used in this document are listed below:

| | |
|------|------------------------------|
| LHD | Leonardo Helicopter Division |
| HC | Helicopter |
| P/N | Part Number |
| S/N | Serial Number |
| N.A. | Not Applicable |

3. DESCRIPTION

This tool is used to remove the fuel booster pump cartridge.

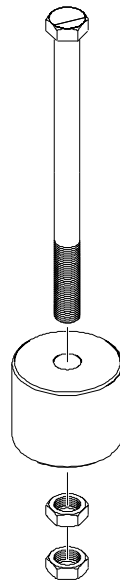

3G2805G00131_1

Figure 1 – Tool, booster pump cartridge removal

4. TOP ASSEMBLY DRAWINGS

Refer to P/N 3G2805G00131 TOOL, BOOSTER PUMP CARTRIDGE REMOVAL.

5. IDENTIFICATION

The tool identification P/N is marked on the tool.

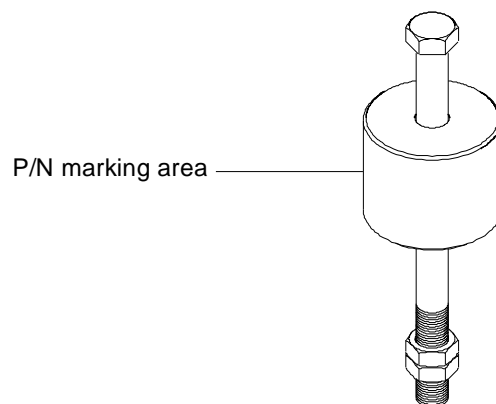

Figure 2 – P/N marking area



GSE & TOOL USE AND MAINTENANCE MANUAL

Manual number:
MAN-3G2805G00131
REV. A

Pag. 8 of 17

6. OVERALL DIMENSIONS

- Length: 48 mm
- Width: 48 mm
- Height: 160 mm

7. WEIGHT

- Total Weight: 1 kg

8. MAIN PARTS

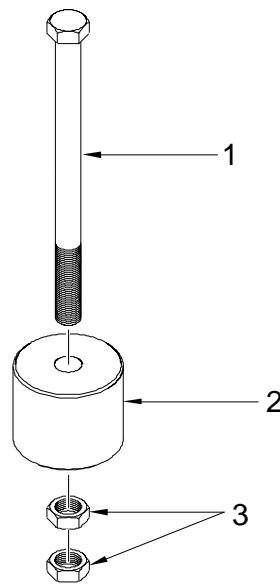

3G2805G00131_2

Figure 3 – Main Parts

The main parts of the TOOL, BOOSTER PUMP CARTRIDGE REMOVAL are:

1. Extractor
2. Slide hammer
3. Nuts

9. MAIN FEATURES DESCRIPTION

This tool is composed of an extractor, a slide hammer and two nuts.

10. WARNING AND SAFETY NOTES

10.1. WARNING NOTE







| | |
|---|---|
|  Warning | <p>Use this equipment only for the purpose that it is designed for. Any other use can result in injury or serious material damage to the components.</p> |
|  Caution | |
|  Notice | <p>The Manual can never integrally replace the adequate competence of the user.</p> |
|  Warning | <p>Before and after each use of the equipment is necessary to perform the checks required. Do not operate with a tool damaged or partially completed, or partially assembled.</p> |
|  Caution | |
|  Notice | <p>This Manual provides guidelines and instructions of the equipment that are in addition to - but are not intended to replace or modify but only to integrate - any general or specific rule, regulation, decree or law that is in force in the place where the equipment is in use.</p> |

Table 3 – Warning Note

10.2. SAFETY NOTES

Remember to wear protective overalls, safety shoes, protective gloves and glasses during all operational and maintenance phases.



Figure 4 – Safety Notes

| | | |
|---|--|--|
|  | GSE & TOOL USE AND MAINTENANCE MANUAL | Manual number: MAN-3G2805G00131 REV. A |
| | | Pag. 12 of 17 |

11. STORAGE

The Tool shall be properly stored to provide protection from external weather conditions, damage and dirty particles.

Ensure that the tool parts are clean before storage.

11.1. LUBRICATION BEFORE STORAGE

N.A.

11.2. STORAGE CONFIGURATION

The tool has no particular storage configuration.

12. MAINTENANCE

NOTE: Correct regular maintenance allows preventing most faults and safeguards of tool performance in time, thereby making it last longer.

Every year carry out regular maintenance on a regular basis as detailed in this manual.

NOTE: Inspection intervals for tool parts placed inside in ready storage is 12 months.

12.1. CLEANING

Before inspection and after each use, carry out the cleaning of the tool components.

12.1.1. SPECIAL TOOLS, FIXTURE AND EQUIPMENT

No special tools, fixture and equipment are required for cleaning.

12.1.2. PART REQUIREMENTS

The parts to clean should be free from the moisture, emulsified water, soaps and metal shavings that can develop of corrosive acids.

They must also be free from wide grease and / or slosh deposits.

12.1.3. MANUAL CLEANING

- A. Clean thoroughly all metal surfaces with a clean lint-free cloth (Local supply) moistened with Cleaning Solvent (MIL-PRF-680C, Type II) to do general spot cleaning of large groups areas. For nylon or Teflon surfaces, the use of a biodegradable, water dilutable cleaning compound (MIL-PRF-87937 D, Type II) is required.
- B. Repeat the cleaning process again by means another clean lint-free cloth (Local supply).
- C. Drying.
 - Verify that the solvent should not be trapped in the cavity. Normally, the solvent evaporates at room temperature in a satisfactory manner.

12.2. CHECKS

Before and after each use or at least every year, carry out the check of kit component.

Before each use ensure that the manual is available to the operator, in the event of loss, request a copy to Leonardo Helicopters Division.

The Tool kit shall be submitted to following checks to guarantee the functionality.

All required checks shall be registered on CHECK RECORDS Table. Ref. *TLC_Table 1*

After each use of tool ensure to have registered the number of uses on HISTORICAL USES RECORD Table. Ref. *TLC_Table 2*

The Tool Log Card template contained in the Annex A of this manual can be replaced with any other log card template in use in the plant where the equipment is in use.

12.2.1. SPECIAL TOOLS, FIXTURE AND EQUIPMENT

No special tools, fixture and equipment are required for the checks.

12.2.2. VISUAL EXAMINATION

NOTE: Replace the parts that do not obey the inspection requirements.

Restore the marking of the parts that results damaged or not readable.

All required visual checks are listed on Table 4

| PERIODICITY | CHECK TYPE | COMPONENTS | |
|----------------------------------|--------------------|---|------|
| BEFORE AND AFTER EVERY USE | VISUAL EXAMINATION | Evidence of impact; | All |
| | | Crushing or stripping | All |
| | | Cracks | All |
| | | Dents | All |
| | | Wear | All |
| | | Distortions | All |
| | | Corrosion | All |
| | | Loose or defective attaching parts (warning flag) | All |
| | | Unsticking of parts | N.A. |
| | | Damage to the threads | All |
| | | Marking | All |

Table 4 – Visual Check

12.2.3. PERIODICAL CHECKS

Not Applicable.

12.2.4. DIMENSIONAL CHECKS

Not Applicable.

12.2.5. SPECIAL CHECKS SUMMARY

Not Applicable.

12.3. REPLACEMENT

All the parts for which it is allowed the components replacement are listed in Paragraph 15.

12.3.1. REPLACEMENT PROCEDURES

The replacement of parts of the kit does not require specific procedures.

13. CALIBRATION

No Calibration is required.

14. SHELF LIFE

Not Applicable.

15. SPARE PARTS

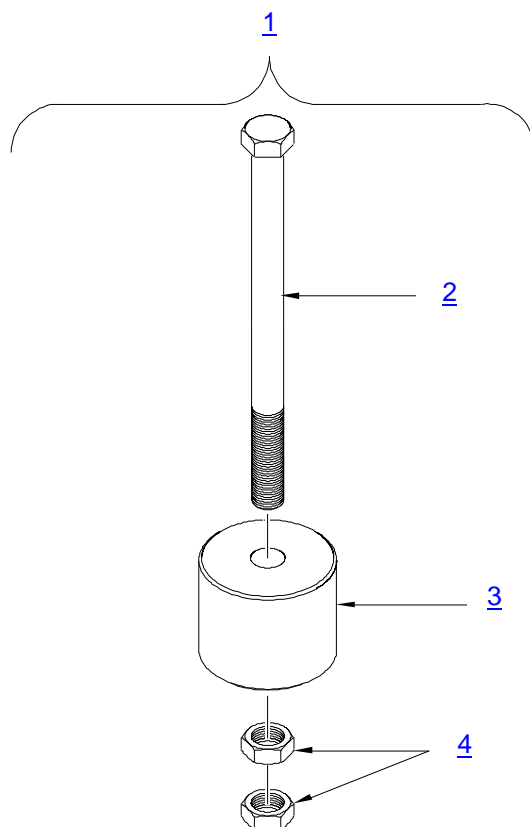

3G2805G00131_3

Figure 5 – Spare Parts

| ITEM | P/N | DESCRIPTION | Q.TY |
|------|--------------|--------------------------------------|------|
| 1 | 3G2805G00131 | TOOL, BOOSTER PUMP CARTRIDGE REMOVAL | REF. |
| 2 | 3G2805G00251 | EXTRACTOR | 1 |
| 3 | 3G2805G00351 | SLIDE HAMMER | 1 |
| 4 | AN316-7R | NUT, PLAIN, HEXAGON | 2 |

Table 5 – Spare Parts

| | | |
|---|--|---|
|  | GSE & TOOL USE AND MAINTENANCE MANUAL | Manual number: MAN-3G2805G00131 REV. A Pag. 16 of 17 |
|---|--|---|

16. CE MARKING

No CE marking is required for the P/N 3G2805G00131 TOOL, BOOSTER PUMP CARTRIDGE REMOVAL.



GSE & TOOL
USE AND MAINTENANCE MANUAL

Manual number:
MAN-3G2805G00131
REV. A

Pag. 17 of 17

ANNEX A

TOOL LOG CARD



TOOL LOG CARD

ISSUE -/
Pag. 1 of 3

| | | |
|-----------------------------|-------------------------------------|-----------------------------|
| TOOL KIT P/N: [1] | TOOL KIT DESCRIPTION: [2] | TOOL KIT S/N: [3] |
| TOOL P/N: [4] | TOOL S/N: [5] | REMARKS: [6] |

Section 1: CHECKS RECORD

| [7] N° check | [8] DATE | [9] P/N TO CHECK | [10] CHECK | [11] FREQUENCY | [12] RESULT | [13] NOTE | CERTIFICATION [14] |
|-----------------------------------|-------------|---------------------|---------------|-------------------|----------------|------------------|------------------------|
| | | | | | | | STAMP & SIGNATURE [15] |
| 1 | | | | | | | |
| 2 | | | | | | | |
| 3 | | | | | | | |
| 4 | | | | | | | |
| 5 | | | | | | | |
| 6 | | | | | | | |
| 7 | | | | | | | |
| 8 | | | | | | | |
| 9 | | | | | | | |
| 10 | | | | | | | |
| FINAL ACCEPTANCE [16] | | | | | | | |
| STAMP & SIGNATURE [17] | | | | | | DATE [18] | |
| | | | | | | | |

TLC_Table 1



TOOL LOG CARD

ISSUE -/-
Pag. 2 of 3

| | | |
|-----------------------------|-------------------------------------|-----------------------------|
| TOOL KIT P/N: [1] | TOOL KIT DESCRIPTION: [2] | TOOL KIT S/N: [3] |
| TOOL P/N: [4] | TOOL S/N: [5] | REMARKS: [6] |

Section 2: HISTORICAL USES RECORD

| [19] N°USE | [8] DATE | [6] NOTE | [13] CERTIFICATION | [19] N°USE | [8] DATE | [6] NOTE | [13] CERTIFICATION |
|---------------|-------------|-------------|---------------------------|---------------|-------------|-------------|---------------------------|
| | | | [14] STAMP & SIGNATURE | | | | [14] STAMP & SIGNATURE |
| 1 | | | | 11 | | | |
| 2 | | | | 12 | | | |
| 3 | | | | 13 | | | |
| 4 | | | | 14 | | | |
| 5 | | | | 15 | | | |
| 6 | | | | 16 | | | |
| 7 | | | | 17 | | | |
| 8 | | | | 18 | | | |
| 9 | | | | 19 | | | |
| 10 | | | | 20 | | | |

TLC_Table 2

LOG CARD FILLING INSTRUCTIONS

| FIELD # | HEADER | NOTE |
|----------------|--|-------------|
| 1 | Part number of the tool Kit | |
| 2 | Tool Kit denomination | |
| 3 | Serial Number of the tool Kit | |
| 4 | Part Number of the tool (part of kit) | |
| 5 | Serial Number of the tool (if applicable) | |
| 6 | Indicate any details of the use | |
| 7 | Sequential number of check performed | |
| 8 | Date of the activity | |
| 9 | PN of tool or component (part of tool) checked/affected by issue | |
| 10 | Typology or description of checks /issue | |
| 11 | Check frequency | |
| 12 | Check result | |
| 13 | Check remarks | |
| 14 | Performance certification | |
| 15 | Stamp and signature of the personnel which performs the check | |
| 16 | Section related to the final approval | |
| 17 | Stamp and signature of the personnel which performs the final approval | |
| 18 | Date on which the final check was made | |
| 19 | Sequential number of performed used of the tool | |