

# GSE & TOOL MANUAL

TITLE

MOORING RINGS ASSY  
P/N 3G1005G01131

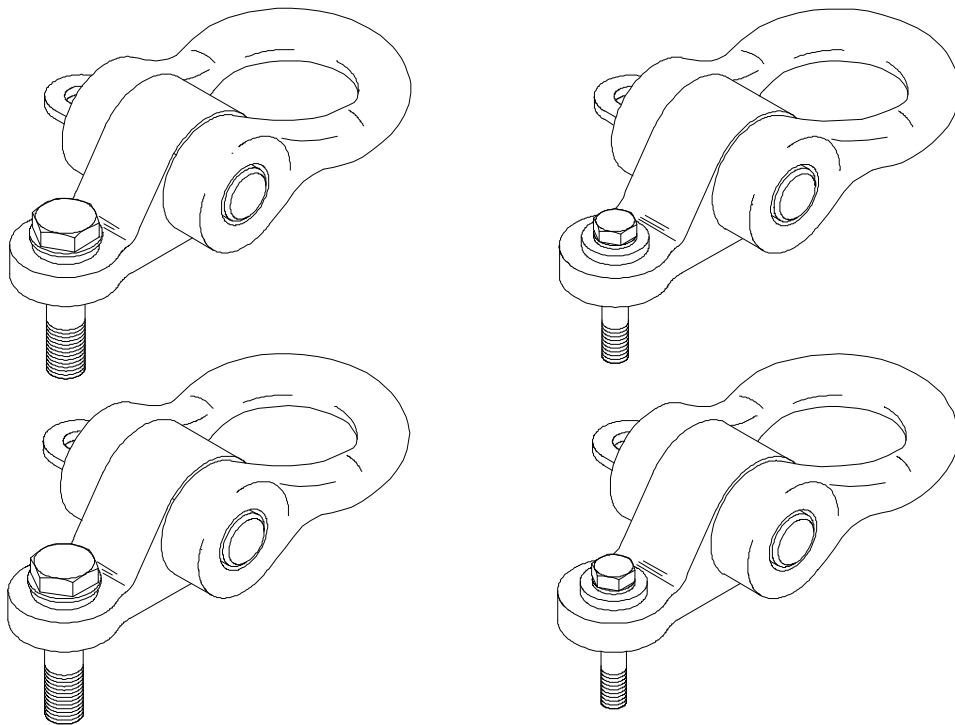

	<b>GSE &amp; TOOL USE AND MAINTENANCE MANUAL</b>	Manual number: <b>MAN-3G1005G01131 REV. A</b>
		Pag. 2 of 17

## REVISION HISTORY

REV	CHANGE DESCRIPTION	DATE
A	First issue	06/10/2021

	<b>GSE &amp; TOOL USE AND MAINTENANCE MANUAL</b>	Manual number: <b>MAN-3G1005G01131 REV. A</b>
		Pag. 3 of 17

## SUMMARY

SUMMARY .....	3
LIST OF TABLE .....	4
LIST OF FIGURE .....	4
1. SCOPE .....	5
1.1. APPLICABILITY .....	5
1.2. OBJECT .....	5
1.3. WARNING AND SAFETY INSTRUCTIONS .....	5
2. DOCUMENTS .....	6
2.1. APPLICABLE DOCUMENTS .....	6
2.2. ACRONYMS USED .....	6
3. DESCRIPTION .....	7
4. TOP ASSEMBLY DRAWINGS .....	7
5. IDENTIFICATION .....	7
6. OVERALL DIMENSIONS .....	8
7. WEIGHT .....	8
8. MAIN PARTS .....	9
9. MAIN FEATURES DESCRIPTION .....	9
10. WARNING AND SAFETY NOTES .....	10
10.1. WARNING NOTE .....	10
10.2. SAFETY NOTES .....	11
11. STORAGE .....	12
11.1. LUBRICATION BEFORE STORAGE .....	12
11.2. STORAGE CONFIGURATION .....	12
12. MAINTENANCE .....	12
12.1. CLEANING .....	12
12.1.1. SPECIAL TOOLS, FIXTURE AND EQUIPMENT .....	12
12.1.2. PART REQUIREMENTS .....	12
12.1.3. MANUAL CLEANING .....	12
12.2. CHECKS .....	13
12.2.1. SPECIAL TOOLS, FIXTURE AND EQUIPMENT .....	13
12.2.2. VISUAL EXAMINATION .....	13
12.2.3. PERIODICAL CHECKS .....	14
12.2.4. DIMENSIONAL CHECKS .....	14
12.2.5. SPECIAL CHECKS SUMMARY .....	14
12.3. REPLACEMENT .....	14
12.3.1. REPLACEMENT PROCEDURES .....	14

	<b>GSE &amp; TOOL USE AND MAINTENANCE MANUAL</b>	Manual number: <b>MAN-3G1005G01131 REV. A</b>
		Pag. 4 of 17

13.	CALIBRATION .....	14
14.	SHELF LIFE .....	14
15.	SPARE PARTS .....	15
16.	CE MARKING.....	16
	ANNEX A.....	17

### LIST OF TABLE

Table 1 – Warning Instruction .....	5
Table 2 – Applicable Documents.....	6
Table 3 – Warning Note.....	10
Table 4 – Visual Check.....	13
Table 5 – Spare Parts.....	15

### LIST OF FIGURE

<i>Figure 1 – Mooring rings assy .....</i>	<i>7</i>
<i>Figure 2 – P/N marking area .....</i>	<i>7</i>
<i>Figure 3 – Main Parts .....</i>	<i>9</i>
<i>Figure 4 – Safety Notes.....</i>	<i>11</i>
<i>Figure 5 – Spare Parts .....</i>	<i>15</i>

## 1. SCOPE

### 1.1. APPLICABILITY



The contents of this document are meant to provide information on the P/N 3G1005G01131 MOORING RINGS ASSY.

### 1.2. OBJECT

The object of this document is to describe the AGE and its components, its main features and it will also provide all needed maintenance requirements to keep in service the P/N 3G1005G01131 MOORING RINGS ASSY.

### 1.3. WARNING AND SAFETY INSTRUCTIONS

A number of symbols are used throughout this document to indicate information to which the user should pay attention to. These are indicated below along with the specific meaning.

 <b>Warning</b>	...Indicates a danger that might arise from a product and might result in severe injuries or even death, if no precautions are taken.
 <b>Caution</b>	... Indicates a potentially dangerous situation, which might result injury or damage to the equipment.
 <b>Notice</b>	...Indicates a note providing information to help the reader during the procedure.

*Table 1 – Warning Instruction*

	<b>GSE &amp; TOOL USE AND MAINTENANCE MANUAL</b>	Manual number: <b>MAN-3G1005G01131 REV. A</b>
		Pag. 6 of 17

## 2. DOCUMENTS

### 2.1. APPLICABLE DOCUMENTS

The following table lists the applicable documents

REF	REFERENCE OF DOCUMENT	TITLE
N.A.	N.A.	N.A.

*Table 2 – Applicable Documents*

### 2.2. ACRONYMS USED

The main acronyms used in this document are listed below:

LHD	Leonardo Helicopter Division
HC	Helicopter
P/N	Part Number
S/N	Serial Number
N.A.	Not Applicable
FWD	Forward

### 3. DESCRIPTION

This tool is used when the helicopter is moored in normal or abnormal conditions for short or long terms in extreme weather conditions.

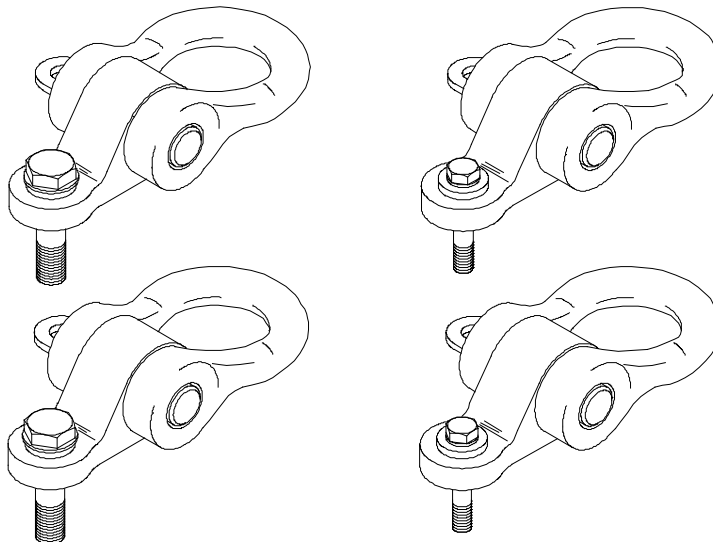

3G1005G01131\_1

Figure 1 – Mooring rings assy

### 4. TOP ASSEMBLY DRAWINGS

Refer to P/N 3G1005G01131 MOORING RINGS ASSY.

### 5. IDENTIFICATION

The tool identification P/N is marked on the tool.

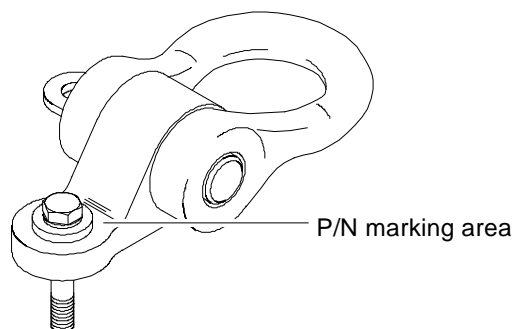

Figure 2 – P/N marking area

	<b>GSE &amp; TOOL USE AND MAINTENANCE MANUAL</b>	Manual number: <b>MAN-3G1005G01131 REV. A</b>
		Pag. 8 of 17

## **6. OVERALL DIMENSIONS**

- Length: 200 mm
- Width: 150 mm
- Height: 120 mm

## **7. WEIGHT**

- Total Weight: Not available



## 8. MAIN PARTS

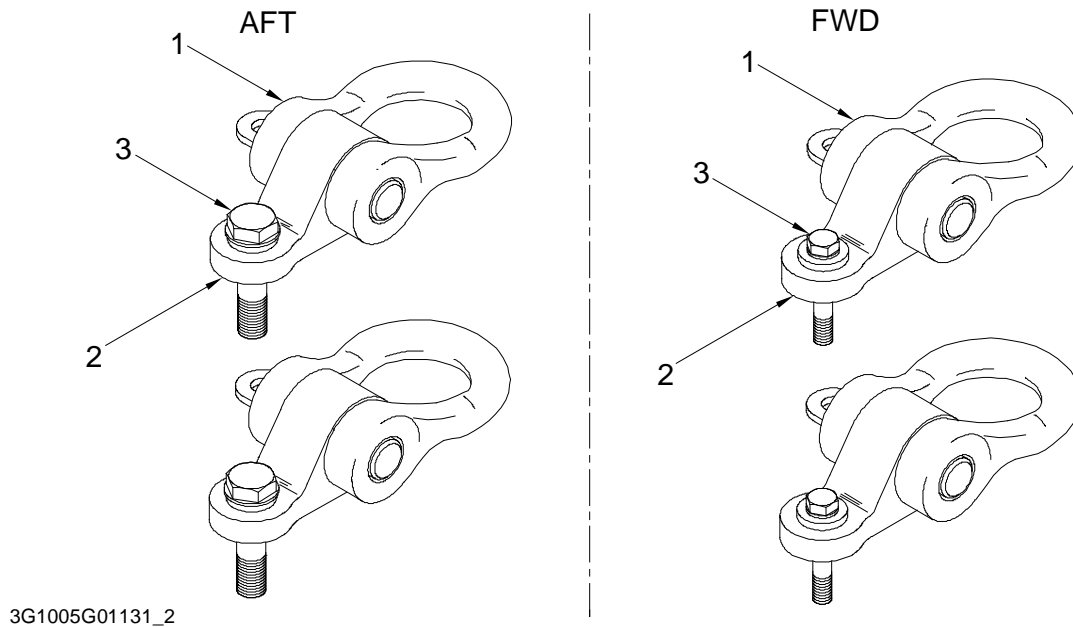

Figure 3 – Main Parts

The main parts of the MOORING RINGS ASSY are:







1. Shackle
2. Bracket
3. Attaching bolt

## 9. MAIN FEATURES DESCRIPTION

The tool is composed of four mooring rings, two to be installed above the aft side of passenger doors and two to be installed above the FWD side of passenger doors.

## 10. WARNING AND SAFETY NOTES

### 10.1. WARNING NOTE

 <b>Warning</b>	Use this equipment only for the purpose that it is designed for. Any other use can result in injury or serious material damage to the components.
 <b>Caution</b>	
 <b>Notice</b>	The Manual can never integrally replace the adequate competence of the user.
 <b>Warning</b>	Before and after each use of the equipment is necessary to perform the checks required. Do not operate with a tool damaged or partially completed, or partially assembled.
 <b>Caution</b>	
 <b>Notice</b>	This Manual provides guidelines and instructions of the equipment that are in addition to - but are not intended to replace or modify but only to integrate - any general or specific rule, regulation, decree or law that is in force in the place where the equipment is in use.

*Table 3 – Warning Note*

## 10.2. SAFETY NOTES

Remember to wear protective overalls, safety shoes, protective gloves and glasses during all operational and maintenance phases.



Figure 4 – Safety Notes

	<b>GSE &amp; TOOL USE AND MAINTENANCE MANUAL</b>	Manual number: <b>MAN-3G1005G01131</b> <b>REV. A</b>
		Pag. 12 of 17

## 11. STORAGE

The Tool shall be properly stored to provide protection from external weather conditions, damage and dirty particles.

Ensure that the tool parts are clean before storage.

### 11.1. LUBRICATION BEFORE STORAGE

N.A.

### 11.2. STORAGE CONFIGURATION

The tool has no particular storage configuration.

## 12. MAINTENANCE

NOTE: Correct regular maintenance allows preventing most faults and safeguards of tool performance in time, thereby making it last longer.

Every year carry out regular maintenance on a regular basis as detailed in this manual.

NOTE: Inspection intervals for tool parts placed inside in ready storage is 12 months.

### 12.1. CLEANING

Before inspection and after each use, carry out the cleaning of the tool components.

#### 12.1.1. SPECIAL TOOLS, FIXTURE AND EQUIPMENT

No special tools, fixture and equipment are required for cleaning.

#### 12.1.2. PART REQUIREMENTS

The parts to clean should be free from the moisture, emulsified water, soaps and metal shavings that can develop of corrosive acids.

They must also be free from wide grease and / or slosh deposits.

#### 12.1.3. MANUAL CLEANING

- A. Clean thoroughly all metal surfaces with a clean lint-free cloth (Local supply) moistened with Cleaning Solvent (MIL-PRF-680C, Type II) to do general spot cleaning of large groups areas. For nylon or Teflon surfaces, the use of a biodegradable, water dilutable cleaning compound (MIL-PRF-87937 D, Type II) is required.
- B. Repeat the cleaning process again by means another clean lint-free cloth (Local supply).
- C. Drying.
  - Verify that the solvent should not be trapped in the cavity. Normally, the solvent evaporates at room temperature in a satisfactory manner.

## 12.2. CHECKS

Before and after each use or at least every year, carry out the check of kit component.

Before each use ensure that the manual is available to the operator, in the event of loss, request a copy to Leonardo Helicopters Division.

The Tool kit shall be submitted to following checks to guarantee the functionality.

All required checks shall be registered on CHECK RECORDS Table. Ref. *TLC\_Table 1*

After each use of tool ensure to have registered the number of uses on HISTORICAL USES RECORD Table. Ref. *TLC\_Table 2*

The Tool Log Card template contained in the Annex A of this manual can be replaced with any other log card template in use in the plant where the equipment is in use.

### 12.2.1. SPECIAL TOOLS, FIXTURE AND EQUIPMENT

No special tools, fixture and equipment are required for the checks.

### 12.2.2. VISUAL EXAMINATION

NOTE: Replace the parts that do not obey the inspection requirements.

Restore the marking of the parts that results damaged or not readable.

All required visual checks are listed on Table 4

PERIODICITY	CHECK TYPE	COMPONENTS	
BEFORE AND AFTER EVERY USE	VISUAL EXAMINATION	Evidence of impact;	All
	Crushing or stripping	All	
	Cracks	All	
	Dents	All	
	Wear	All	
	Distortions	All	
	Corrosion	All	
	Loose or defective attaching parts (warning flag)	All	
	Unsticking of parts	N.A.	
	Damage to the threads	All threaded STD parts	
	Marking	All	

*Table 4 – Visual Check*

	<b>GSE &amp; TOOL USE AND MAINTENANCE MANUAL</b>	Manual number: <b>MAN-3G1005G01131 REV. A</b>
		Pag. 14 of 17

### **12.2.3. PERIODICAL CHECKS**

Not Applicable.

### **12.2.4. DIMENSIONAL CHECKS**

Not Applicable.

### **12.2.5. SPECIAL CHECKS SUMMARY**

Not Applicable.

## **12.3. REPLACEMENT**

All the parts for which it is allowed the components replacement are listed in Paragraph 15.

### **12.3.1. REPLACEMENT PROCEDURES**

The replacement of parts of the kit does not require specific procedures.

## **13. CALIBRATION**

No Calibration is required.

## **14. SHELF LIFE**

Not Applicable.

## 15. SPARE PARTS

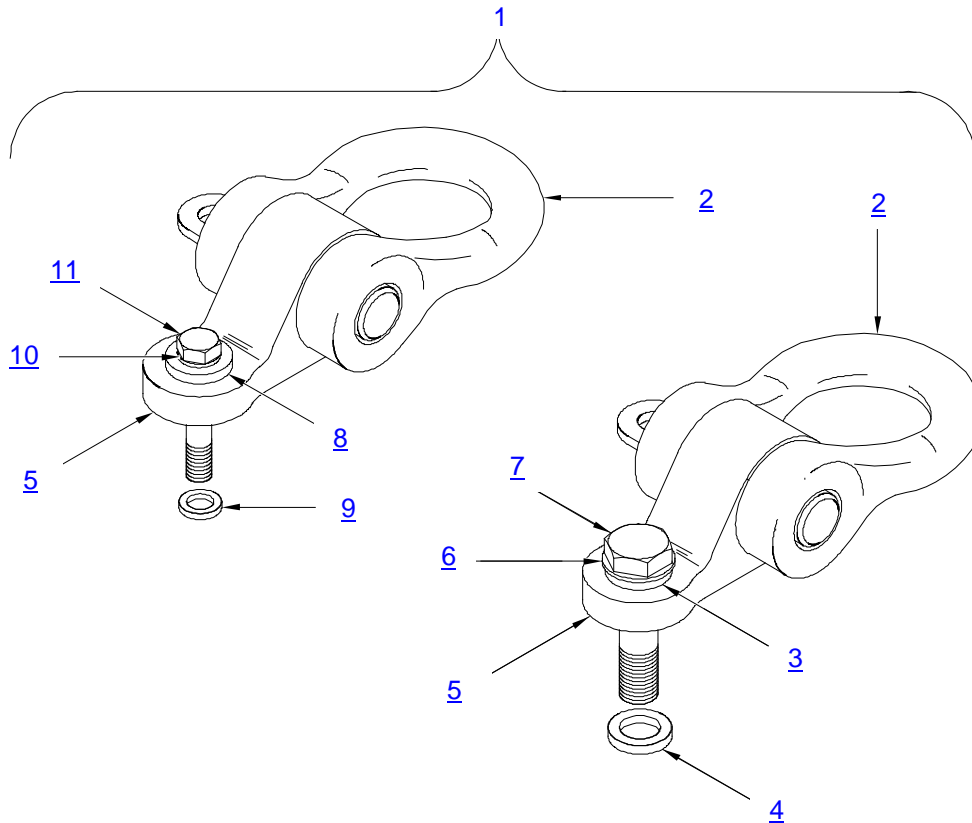

3G1005G01131\_3

Figure 5 – Spare Parts

ITEM	P/N	DESCRIPTION	Q.TY
1	3G1005G01131	MOORING RINGS ASSY	REF.
2	GP4-1/8.5	SHACKLE	4
3	3G1005G01351	BUSHING	2
4	3G1005G01551	WASHER	2
5	3G1005G01251	BRACKET	4
6	NAS1149F0963P	WASHER	2
7	AN9-22	BOLT, MACHINE	2
8	3G1005G01451	BUSHING	2
9	3G1005G01651	WASHER	2
10	NAS1149F0663P	WASHER	2
11	AN6-21	BOLT, MACHINE	2

Table 5 – Spare Parts

	<b>GSE &amp; TOOL USE AND MAINTENANCE MANUAL</b>	Manual number: <b>MAN-3G1005G01131 REV. A</b>
		Pag. 16 of 17

## **16. CE MARKING**

No CE marking is required for the P/N 3G1005G01131 MOORING RINGS ASSY.



	<b>GSE &amp; TOOL USE AND MAINTENANCE MANUAL</b>	Manual number: <b>MAN-3G1005G01131 REV. A</b>
		Pag. 17 of 17

# **ANNEX A**

## **TOOL LOG CARD**



# TOOL LOG CARD

ISSUE -/-  
Pag. 1 of 3

<b>TOOL KIT P/N:</b> [1]	<b>TOOL KIT DESCRIPTION:</b> [2]	<b>TOOL KIT S/N:</b> [3]
<b>TOOL P/N:</b> [4]	<b>TOOL S/N:</b> [5]	<b>REMARKS:</b> [6]

## Section 1: CHECKS RECORD

[7] N° check	[8] DATE	[9] P/N TO CHECK	[10] CHECK	[11] FREQUENCY	[12] RESULT	[13] NOTE	[14] CERTIFICATION
							[15] STAMP & SIGNATURE
1							
2							
3							
4							
5							
6							
7							
8							
9							
10							

<b>FINAL ACCEPTANCE</b> [16]	
<b>STAMP &amp; SIGNATURE</b> [17]	<b>DATE</b> [18]

TLC\_Table 1



# TOOL LOG CARD

ISSUE -/-  
Pag. 2 of 3

<b>TOOL KIT P/N:</b> [1]	<b>TOOL KIT DESCRIPTION:</b> [2]	<b>TOOL KIT S/N:</b> [3]
<b>TOOL P/N:</b> [4]	<b>TOOL S/N:</b> [5]	<b>REMARKS:</b> [6]

## Section 2: HISTORICAL USES RECORD

[19] N°USE	[8] DATE	[6] NOTE	[13] CERTIFICATION		[19] N°USE	[8] DATE	[6] NOTE	[13] CERTIFICATION	
			[14] STAMP & SIGNATURE					[14] STAMP & SIGNATURE	
1					11				
2					12				
3					13				
4					14				
5					15				
6					16				
7					17				
8					18				
9					19				
10					20				

TLC\_Table 2

## LOG CARD FILLING INSTRUCTIONS

<b>FIELD #</b>	<b>HEADER</b>	<b>NOTE</b>
1	Part number of the tool Kit	
2	Tool Kit denomination	
3	Serial Number of the tool Kit	
4	Part Number of the tool (part of kit)	
5	Serial Number of the tool (if applicable)	
6	Indicate any details of the use	
7	Sequential number of check performed	
8	Date of the activity	
9	PN of tool or component (part of tool) checked/affected by issue	
10	Typology or description of checks /issue	
11	Check frequency	
12	Check result	
13	Check remarks	
14	Performance certification	
15	Stamp and signature of the personnel which performs the check	
16	Section related to the final approval	
17	Stamp and signature of the personnel which performs the final approval	
18	Date on which the final check was made	
19	Sequential number of performed used of the tool	