



**GSE & TOOL  
USE AND MAINTENANCE MANUAL**

Manual number:  
**MAN-3G7605G01031  
REV. A**

Pag. 1 of 17

# **GSE & TOOL MANUAL**

<b>TITLE</b>	<b>CENTERING PIN, ENGINE CONTROL GEARBOX P/N 3G7605G01031</b>
--------------	---

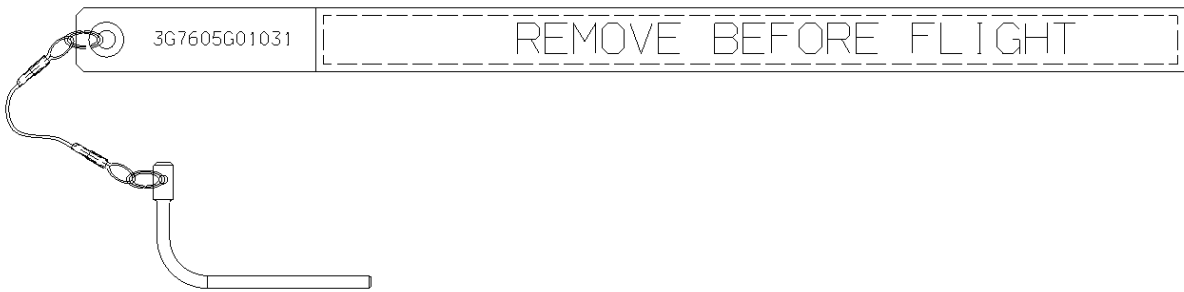

	<b>GSE &amp; TOOL USE AND MAINTENANCE MANUAL</b>	Manual number: <b>MAN-3G7605G01031</b> <b>REV. A</b>
		Pag. 2 of 17

## REVISION HISTORY

REV	CHANGE DESCRIPTION	DATE
A	First issue	07/09/2021

## SUMMARY

SUMMARY .....	3
LIST OF TABLE .....	4
LIST OF FIGURE .....	4
1. SCOPE .....	5
1.1. APPLICABILITY .....	5
1.2. OBJECT .....	5
1.3. WARNING AND SAFETY INSTRUCTIONS .....	5
2. DOCUMENTS .....	6
2.1. APPLICABLE DOCUMENTS .....	6
2.2. ACRONYMS USED .....	6
3. DESCRIPTION .....	7
4. TOP ASSEMBLY DRAWINGS .....	7
5. IDENTIFICATION .....	7
6. OVERALL DIMENSIONS .....	8
7. WEIGHT .....	8
8. MAIN PARTS .....	9
9. MAIN FEATURES DESCRIPTION .....	9
10. WARNING AND SAFETY NOTES .....	10
10.1. WARNING NOTE .....	10
10.2. SAFETY NOTES .....	11
11. STORAGE .....	12
11.1. LUBRICATION BEFORE STORAGE .....	12
11.2. STORAGE CONFIGURATION .....	12
12. MAINTENANCE .....	12
12.1. CLEANING .....	12
12.1.1. SPECIAL TOOLS, FIXTURE AND EQUIPMENT .....	12
12.1.2. PART REQUIREMENTS .....	12
12.1.3. MANUAL CLEANING .....	12
12.2. CHECKS .....	13
12.2.1. SPECIAL TOOLS, FIXTURE AND EQUIPMENT .....	13
12.2.2. VISUAL EXAMINATION .....	13
12.2.3. PERIODICAL CHECKS .....	14
12.2.4. DIMENSIONAL CHECKS .....	14
12.2.5. SPECIAL CHECKS SUMMARY .....	14
12.3. REPLACEMENT .....	14
12.3.1. REPLACEMENT PROCEDURES .....	14



# GSE & TOOL USE AND MAINTENANCE MANUAL

Manual number:  
**MAN-3G7605G01031**  
**REV. A**

Pag. 4 of 17

13.	CALIBRATION .....	14
14.	SHELF LIFE .....	14
15.	SPARE PARTS .....	15
16.	CE MARKING.....	16
	ANNEX A.....	17

## LIST OF TABLE

Table 1 – Warning Instruction .....	5
Table 2 – Applicable Documents.....	6
Table 3 – Warning Note.....	10
Table 4 – Visual Check.....	13
Table 5 – Spare Parts.....	15

## LIST OF FIGURE

<i>Figure 1 – Centering Pin.....</i>	<i>7</i>
<i>Figure 2 – P/N marking area .....</i>	<i>7</i>
<i>Figure 3 – Main Parts .....</i>	<i>9</i>
<i>Figure 4 – Safety Notes.....</i>	<i>11</i>
<i>Figure 5 – Spare Parts .....</i>	<i>15</i>

## 1. SCOPE

### 1.1. APPLICABILITY



The contents of this document are meant to provide information on the P/N 3G7605G01031 CENTERING PIN, ENGINE CONTROL GEARBOX.

### 1.2. OBJECT

The object of this document is to describe the AGE and its components, its main features and it will also provide all needed maintenance requirements to keep in service the P/N 3G7605G01031 CENTERING PIN, ENGINE CONTROL GEARBOX.

### 1.3. WARNING AND SAFETY INSTRUCTIONS

A number of symbols are used throughout this document to indicate information to which the user should pay attention to. These are indicated below along with the specific meaning.

 <b>Warning</b>	...Indicates a danger that might arise from a product and might result in severe injuries or even death, if no precautions are taken.
 <b>Caution</b>	... Indicates a potentially dangerous situation, which might result injury or damage to the equipment.
 <b>Notice</b>	...Indicates a note providing information to help the reader during the procedure.

*Table 1 – Warning Instruction*

	<b>GSE &amp; TOOL USE AND MAINTENANCE MANUAL</b>	Manual number: <b>MAN-3G7605G01031</b> <b>REV. A</b>
		Pag. 6 of 17

## 2. DOCUMENTS

### 2.1. APPLICABLE DOCUMENTS

The following table lists the applicable documents

REF	REFERENCE OF DOCUMENT	TITLE
N.A.	N.A.	N.A.

*Table 2 – Applicable Documents*

### 2.2. ACRONYMS USED

The main acronyms used in this document are listed below:

LHD	Leonardo Helicopter Division
HC	Helicopter
P/N	Part Number
S/N	Serial Number
N.A.	Not Applicable

### 3. DESCRIPTION

This tool is necessary to perform the adjustment of the Number 1 & Number 2 engine control gearbox. It is used in order to guarantee that the flight management module shaft is in neutral position.

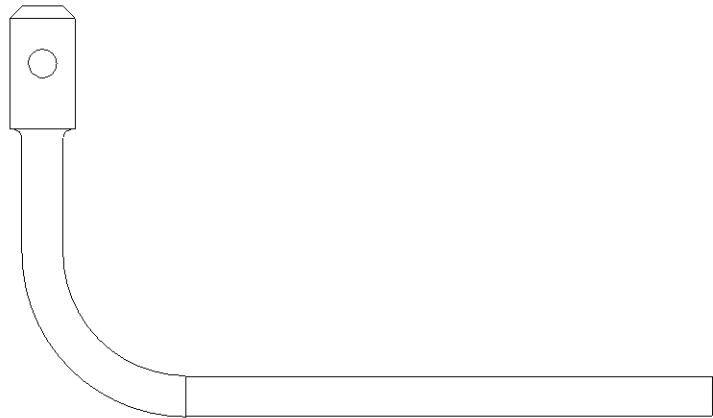

3G7605G01031\_1

Figure 1 – Centering Pin

### 4. TOP ASSEMBLY DRAWINGS

Refer to P/N 3G7605G01031 CENTERING PIN, ENGINE CONTROL GEARBOX.

### 5. IDENTIFICATION

The tool identification P/N is marked on the tool.

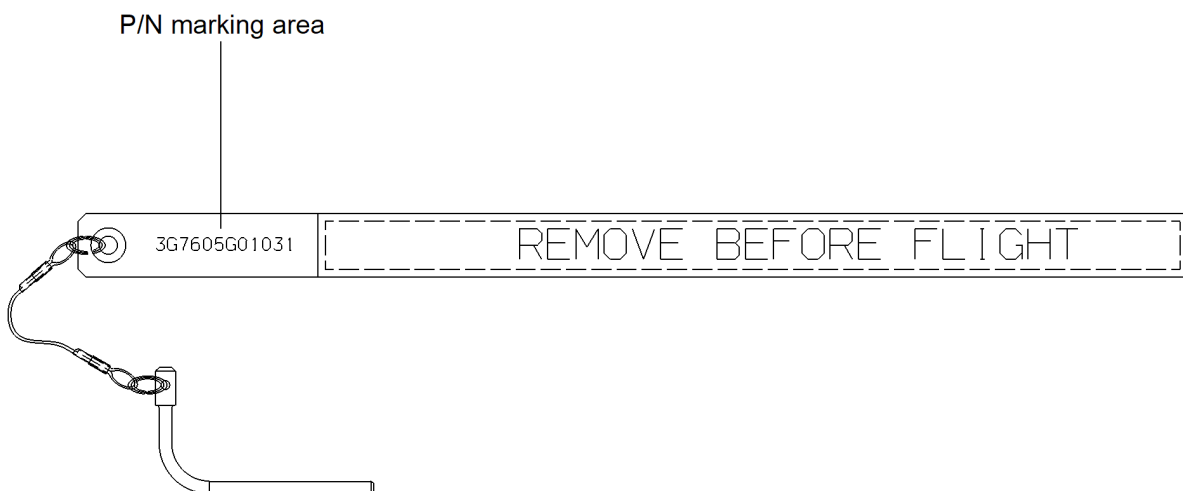

Figure 2 – P/N marking area



## GSE & TOOL USE AND MAINTENANCE MANUAL

Manual number:  
**MAN-3G7605G01031**  
**REV. A**

Pag. 8 of 17

### 6. OVERALL DIMENSIONS

- Length: 85 mm
- Width: 50 mm
- Height: 8 mm

### 7. WEIGHT

- Total Weight: 0,05 kg



## 8. MAIN PARTS

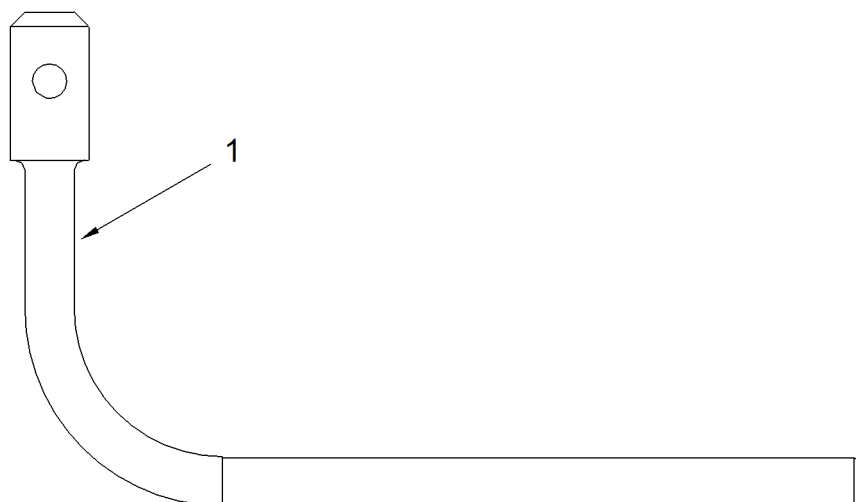

3G7605G01031\_2

*Figure 3 – Main Parts*

The main parts of the Centering Pin, Engine Control Gearbox are:







1. Centering pin

## 9. MAIN FEATURES DESCRIPTION

The tool is composed of a centering pin.

## 10. WARNING AND SAFETY NOTES

### 10.1. WARNING NOTE

 <b>Warning</b>	<p>Use this equipment only for the purpose that it is designed for. Any other use can result in injury or serious material damage to the components.</p>
 <b>Caution</b>	
 <b>Notice</b>	<p>The Manual can never integrally replace the adequate competence of the user.</p>
 <b>Warning</b>	<p>Before and after each use of the equipment is necessary to perform the checks required. Do not operate with a tool damaged or partially completed, or partially assembled.</p>
 <b>Caution</b>	
 <b>Notice</b>	<p>This Manual provides guidelines and instructions of the equipment that are in addition to - but are not intended to replace or modify but only to integrate - any general or specific rule, regulation, decree or law that is in force in the place where the equipment is in use.</p>

*Table 3 – Warning Note*

## 10.2. SAFETY NOTES

Remember to wear protective overalls, safety shoes, protective gloves and glasses during all operational and maintenance phases.



*Figure 4 – Safety Notes*

	<b>GSE &amp; TOOL USE AND MAINTENANCE MANUAL</b>	Manual number: <b>MAN-3G7605G01031</b> <b>REV. A</b>
		Pag. 12 of 17

## 11. STORAGE

The Tool shall be properly stored to provide protection from external weather conditions, damage and dirty particles.

Ensure that the tool parts are clean before storage.

### 11.1. LUBRICATION BEFORE STORAGE

N.A.

### 11.2. STORAGE CONFIGURATION

The tool has no particular storage configuration.

## 12. MAINTENANCE

NOTE: Correct regular maintenance allows preventing most faults and safeguards of tool performance in time, thereby making it last longer.

Every year carry out regular maintenance on a regular basis as detailed in this manual.

NOTE: Inspection intervals for tool parts placed inside in ready storage is 12 months.

### 12.1. CLEANING

Before inspection and after each use, carry out the cleaning of the tool components.

#### 12.1.1. SPECIAL TOOLS, FIXTURE AND EQUIPMENT

No special tools, fixture and equipment are required for cleaning.

#### 12.1.2. PART REQUIREMENTS

The parts to clean should be free from the moisture, emulsified water, soaps and metal shavings that can develop of corrosive acids.

They must also be free from wide grease and / or slush deposits.

#### 12.1.3. MANUAL CLEANING

- A. Clean thoroughly all metal surfaces with a clean lint-free cloth (Local supply) moistened with Cleaning Solvent (MIL-PRF-680C, Type II) to do general spot cleaning of large groups areas. For nylon or Teflon surfaces, the use of a biodegradable, water dilutable cleaning compound (MIL-PRF-87937 D, Type II) is required.
- B. Repeat the cleaning process again by means another clean lint-free cloth (Local supply).
- C. Drying.
  - Verify that the solvent should not be trapped in the cavity. Normally, the solvent evaporates at room temperature in a satisfactory manner.

## 12.2. CHECKS

Before and after each use or at least every year, carry out the check of kit component.

Before each use ensure that the manual is available to the operator, in the event of loss, request a copy to Leonardo Helicopters Division.

The Tool kit shall be submitted to following checks to guarantee the functionality.

All required checks shall be registered on CHECK RECORDS Table. Ref. *TLC\_Table 1*

After each use of tool ensure to have registered the number of uses on HISTORICAL USES RECORD Table. Ref. *TLC\_Table 2*

The Tool Log Card template contained in the Annex A of this manual can be replaced with any other log card template in use in the plant where the equipment is in use.

### 12.2.1. SPECIAL TOOLS, FIXTURE AND EQUIPMENT

No special tools, fixture and equipment are required for the checks.

### 12.2.2. VISUAL EXAMINATION

NOTE: Replace the parts that do not obey the inspection requirements.

Restore the marking of the parts that results damaged or not readable.

All required visual checks are listed on 3G7605G01031

PERIODICITY	CHECK TYPE	COMPONENTS	
BEFORE AND AFTER EVERY USE	VISUAL EXAMINATION	Evidence of impact;	All
	Crushing or stripping	All	
	Cracks	All	
	Dents	All	
	Wear	All	
	Distortions	All	
	Corrosion	All	
	Loose or defective attaching parts (warning flag)	All	
	Unsticking of parts	N.A.	
	Damage to the threads	N.A.	
	Marking	All	

*Table 4 – Visual Check*



## GSE & TOOL USE AND MAINTENANCE MANUAL

Manual number:  
**MAN-3G7605G01031**  
**REV. A**

Pag. 14 of 17

### **12.2.3. PERIODICAL CHECKS**

Not Applicable.

### **12.2.4. DIMENSIONAL CHECKS**

Not Applicable.

### **12.2.5. SPECIAL CHECKS SUMMARY**

Not Applicable.

## **12.3. REPLACEMENT**

All the parts for which it is allowed the components replacement are listed in Paragraph 15.

### **12.3.1. REPLACEMENT PROCEDURES**

The replacement of parts of the kit does not require specific procedures.

## **13. CALIBRATION**

No Calibration is required.

## **14. SHELF LIFE**

Not Applicable.

## 15. SPARE PARTS

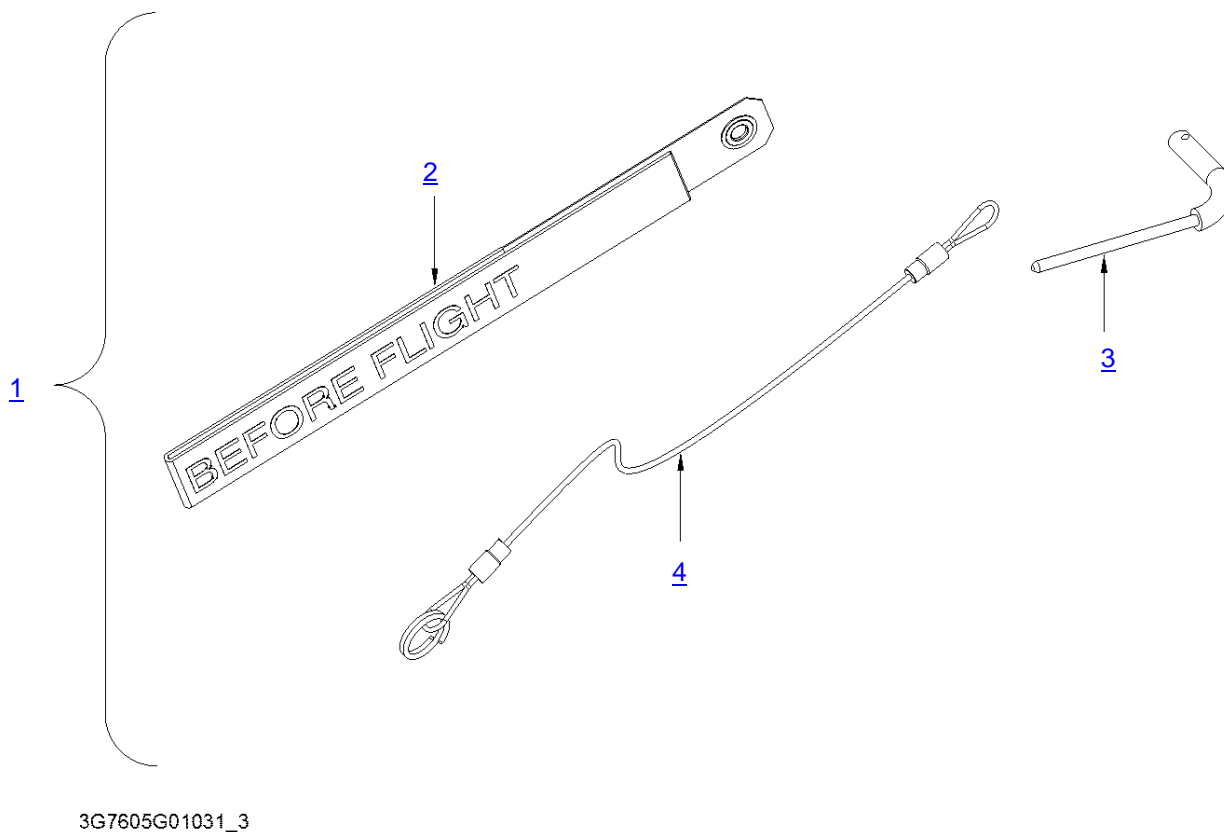

Figure 5 – Spare Parts

ITEM	P/N	DESCRIPTION	Q.TY
1	3G7605G01031	CENTERING PIN, ENGINE CONTROL GEARBOX	REF.
2	109-3901-04-101	STRAP, CAUTION	1
3	3G7605G01151	CENTERING PIN, ENGINE	1
4	AS44445D200D	LANYARD NOMEX	1

Table 5 – Spare Parts

	<b>GSE &amp; TOOL USE AND MAINTENANCE MANUAL</b>	Manual number: <b>MAN-3G7605G01031 REV. A</b> Pag. 16 of 17
---	--	---

## 16. CE MARKING

No CE marking is required for the P/N 3G7605G01031 CENTERING PIN, ENGINE CONTROL GEARBOX.





GSE & TOOL  
USE AND MAINTENANCE MANUAL

Manual number:  
**MAN-3G7605G01031**  
**REV. A**

Pag. 17 of 17

# ANNEX A

# TOOL LOG CARD



# TOOL LOG CARD

ISSUE -/  
Pag. 1 of 3

<b>TOOL KIT P/N:</b> [1]	<b>TOOL KIT DESCRIPTION:</b> [2]	<b>TOOL KIT S/N:</b> [3]
<b>TOOL P/N:</b> [4]	<b>TOOL S/N:</b> [5]	<b>REMARKS:</b> [6]

## Section 1: CHECKS RECORD

[7] N° check	[8] DATE	[9] P/N TO CHECK	[10] CHECK	[11] FREQUENCY	[12] RESULT	[13] NOTE	CERTIFICATION [14]
							STAMP & SIGNATURE [15]
1							
2							
3							
4							
5							
6							
7							
8							
9							
10							
<b>FINAL ACCEPTANCE [16]</b>							
<b>STAMP &amp; SIGNATURE [17]</b>						<b>DATE [18]</b>	

TLC\_Table 1



# TOOL LOG CARD

ISSUE -/-  
Pag. 2 of 3

<b>TOOL KIT P/N:</b> [1]	<b>TOOL KIT DESCRIPTION:</b> [2]	<b>TOOL KIT S/N:</b> [3]
<b>TOOL P/N:</b> [4]	<b>TOOL S/N:</b> [5]	<b>REMARKS:</b> [6]

## Section 2: HISTORICAL USES RECORD

[19] N°USE	[8] DATE	[6] NOTE	[13] CERTIFICATION	[19] N°USE	[8] DATE	[6] NOTE	[13] CERTIFICATION
			[14] STAMP & SIGNATURE				[14] STAMP & SIGNATURE
1				11			
2				12			
3				13			
4				14			
5				15			
6				16			
7				17			
8				18			
9				19			
10				20			

TLC\_Table 2

## LOG CARD FILLING INSTRUCTIONS

<b>FIELD #</b>	<b>HEADER</b>	<b>NOTE</b>
<b>1</b>	Part number of the tool Kit	
<b>2</b>	Tool Kit denomination	
<b>3</b>	Serial Number of the tool Kit	
<b>4</b>	Part Number of the tool (part of kit)	
<b>5</b>	Serial Number of the tool (if applicable)	
<b>6</b>	Indicate any details of the use	
<b>7</b>	Sequential number of check performed	
<b>8</b>	Date of the activity	
<b>9</b>	PN of tool or component (part of tool) checked/affected by issue	
<b>10</b>	Typology or description of checks /issue	
<b>11</b>	Check frequency	
<b>12</b>	Check result	
<b>13</b>	Check remarks	
<b>14</b>	Performance certification	
<b>15</b>	Stamp and signature of the personnel which performs the check	
<b>16</b>	Section related to the final approval	
<b>17</b>	Stamp and signature of the personnel which performs the final approval	
<b>18</b>	Date on which the final check was made	
<b>19</b>	Sequential number of performed used of the tool	