SERVICE BULLETIN
OPTIONAL**N° 139-266****DATE:** October 7, 2011**REV. :** B - June 20, 2023

TITLE**ATA 25 - INSTALLATION OF KIT BAMBI BUCKET PROVISION****REVISION LOG**

Helicopters that have complied with previous issue of this Service Bulletin do not need any additional action.

Revision A is issued to allow the installation of kit P/N 4G2590F00311.

Part II of Rev. A corresponds to the previous issue of this SB.

Revision B is issued to allow the installation of kit P/N 4G2590F00314 for Long Nose AW139 helicopters.

Parts I and II of Rev. B correspond to the previous issue of this SB.

Due to the large amount of modifications introduced in this new revision, revision bars are not shown.

1. PLANNING INFORMATION

A. EFFECTIVITY

Part I: AB/AW139 helicopters from S/N 31005 to S/N 31157 except S/N 31007 and from S/N 41001 to S/N 41023.

Part II: AW139 helicopters from S/N 31201 to S/N 31398 and from S/N 41201 to S/N 41293 except S/N 41237.

Part III: AW139 helicopters from S/N 31400 onwards and from S/N 41300 onwards.

B. COMPLIANCE

At Customer's option.

C. CONCURRENT REQUIREMENTS

N.A.

D. REASON

This Service Bulletin is issued in order to provide all necessary instructions on how to perform the installation of kit Bambi bucket provision P/N 4G2590F00311, P/N 4G2590F00312 or P/N 4G2590F00314.

LHD issued this SB for the following reason:

| | |
|--|---|
| Helicopter Reliability/Maintainability | |
| Product Improvement | |
| Obsolescence | |
| Customization | ✓ |
| Product/Capability Enhancement | |

E. DESCRIPTION

The kit Bambi Bucket provision allows to perform the structural and electrical provision on the helicopter necessary for the installation of a Bambi Bucket system for the aerial firefighting operations.

The external equipment installation of Bambi Bucket system is not included in this provisional kit.

F. APPROVAL

The technical content of this Service Bulletin is approved under the authority of DOA nr. EASA.21.J.005. For helicopters registered under other Aviation Authorities, before

applying the Service Bulletin, applicable Aviation Authority approval must be checked within Leonardo Helicopters customer portal.

EASA states mandatory compliance with inspections, modifications or technical directives and related time of compliance by means of relevant Airworthiness Directives. If an aircraft listed in the effectivity embodies a modification or repair not LHD certified and affecting the content of this Service Bulletin, it is responsibility of the Owner/Operator to obtain a formal approval by Aviation Authority having jurisdiction on the aircraft, for any adaptation necessary before incorporation of the present Service Bulletin.

G. MANPOWER

To comply with this Service Bulletin the following MMH are deemed necessary:

Part I: approximately one hundred and twenty (120) MMH;

Part II: approximately eighty (80) MMH.

Part III: approximately eighty (80) MMH.

MMH are based on hands-on time and can change with personnel and facilities available.

H. WEIGHT AND BALANCE

PART I

| WEIGHT (Kg) | ARM (mm) | MOMENT (Kgmm) |
|----------------------|----------|---------------|
| | | 1.52 |
| LONGITUDINAL BALANCE | 3400 | 5168 |
| LATERAL BALANCE | 587 | 892,24 |

PART II

| WEIGHT (Kg) | ARM (mm) | MOMENT (Kgmm) |
|----------------------|----------|---------------|
| | | 0.74 |
| LONGITUDINAL BALANCE | 3398 | 2514,52 |
| LATERAL BALANCE | -309 | -228,66 |

PART III

| WEIGHT (Kg) | ARM (mm) | MOMENT (Kgmm) |
|----------------------|----------|---------------|
| | | 0,69 |
| LONGITUDINAL BALANCE | 3690 | 2546,10 |
| LATERAL BALANCE | -415 | -286,35 |

I. REFERENCES

I.1 PUBLICATIONS

Following Data Modules refer to AMP:

| <u>DATA MODULE</u> | <u>DESCRIPTION</u> | <u>PART</u> |
|-------------------------------|---|-------------|
| DM01 39-A-00-20-00-00A-120A-A | Helicopter on ground for a safe maintenance. | I, II, III |
| DM02 39-A-24-91-04-00A-920A-K | Integrally lighted panel - Replacement. | I, II |
| DM03 39-A-06-41-00-00A-010A-A | Access doors and panels - General data. | III |
| DM04 39-A-20-10-01-00A-259A-A | Ground connections - Other procedures to protect surfaces | III |
| DM05 39-A-11-00-01-00A-720A-A | Decal – Install procedure. | III |
| DM06 39-A-20-10-08-00A-622A-A | Electrical contacts - Crimp | III |

I.2 ACRONYMS & ABBREVIATIONS

| | |
|------|----------------------------------|
| AMP | Aircraft Maintenance Publication |
| CA | Cable Assembly |
| CB | Circuit Breaker |
| DM | Data Module |
| DOA | Design Organization Approval |
| EASA | European Aviation Safety Agency |
| LH | Left-Hand |
| LHD | Leonardo Helicopter Division |
| LS | Local Supply |
| MMH | Maintenance Man Hours |
| N.A. | Not Applicable |
| P/N | Part Number |
| RH | Right |
| S/N | Serial Number |
| SB | Service Bulletin |
| WD | Wiring Diagram |

J. PUBLICATIONS AFFECTED

N.A.

K. SOFTWARE ACCOMPLISHMENT SUMMARY

N.A.

2. MATERIAL INFORMATION

A. REQUIRED MATERIALS

PARTS

| <u>PART I</u> | | | | | | | |
|----------------------|-----------------|-----------------|------------------------------------|------|-----|------|-----------|
| # | P/N | ALTERNATIVE P/N | DESCRIPTION | Q.TY | LVL | NOTE | LOG P/N |
| 1 | 4G2590F00311 | | KIT BAMBI BUCKET PROVISION | REF | . | | - |
| 2 | 3G6712A00737 | | Pilot cyclic stick assy (NVG) | 1 | .. | | 139-266L1 |
| 3 | 3G6712A00837 | | Copilot cyclic stick assy (NVG) | 1 | .. | | 139-266L1 |
| 4 | 3G9B01A18801 | | Fire bucket C/A (B1A188) | 1 | .. | | 139-266L1 |
| 5 | 3G9B01B13901 | | Fire bucket C/A (B1B139) | 1 | .. | | 139-266L1 |
| 6 | 3G9C01A11001 | | Fire bucket C/A (C1A110) | 1 | .. | | 139-266L1 |
| 7 | 3G9C01B11201 | | Fire bucket C/A (C1B112) | 1 | .. | | 139-266L1 |
| 8 | A363A01 | | Ground Stud | 1 | .. | | 139-266L1 |
| 9 | A366A3E08C | | Electrical support | 1 | .. | | 139-266L1 |
| 10 | A366A3E20C | | Electrical support | 1 | .. | | 139-266L1 |
| 11 | A649A01 | | Relay | 2 | .. | | 139-266L1 |
| 12 | ED300GS55 | | Decal | 1 | .. | | 139-266L1 |
| 13 | ED300J137 | | Decal | 1 | .. | | 139-266L1 |
| 14 | ED300K94 | | Decal | 1 | .. | | 139-266L1 |
| 15 | ED300K95 | | Decal | 1 | .. | | 139-266L1 |
| 16 | M85049/95-16A-A | | Flange | 2 | .. | | 139-266L1 |
| 17 | MS21042L3 | | Nut | 2 | .. | | 139-266L1 |
| 18 | MS21919WDG5 | AS21919WDG05 | Clamp | 2 | .. | | 139-266L1 |
| 19 | MS3115-16L | | Dummy connector | 1 | .. | | 139-266L1 |
| 20 | MS3181-16C | MS3181-16CA | Cover | 1 | .. | | 139-266L1 |
| 21 | MS35206-215 | | Screw | 4 | .. | | 139-266L1 |
| 22 | MS35206-216 | | Screw | 4 | .. | | 139-266L1 |
| 23 | NAS1149D0332J | | Washer | 6 | .. | | 139-266L1 |
| 24 | NAS43DD3-40N | | Spacer | 1 | .. | | 139-266L1 |
| 25 | NAS1149DN416J | | Washer | 8 | . | | 139-266L1 |
| 26 | 3G5315A40851 | | Support | 1 | . | | 139-266L1 |
| 27 | A824A01A-A1 | | Bracket | 1 | . | | 139-266L1 |
| 28 | MS35207-260 | | Screw | 4 | . | | 139-266L1 |
| 29 | NAS1836-3-13 | | Insert | 4 | . | | 139-266L1 |
| 30 | A556A-T16 | | Wire | 1m | . | | 139-266L1 |
| 31 | A556A-T20 | | Wire | 1m | . | | 139-266L1 |
| 32 | ED300CB211 | | Decal | 1 | . | | 139-266L1 |
| 33 | ED300S203 | | Decal | 1 | . | | 139-266L1 |
| 34 | MS27722-22 | | Switch | 1 | . | | 139-266L1 |
| 35 | MS3320-7-1/2 | | Circuit Breaker | 1 | . | | 139-266L1 |
| 36 | MS25036-153 | | Electrical contact | 1 | . | | 139-266L1 |
| 37 | M39029/1-16-20 | | Electrical contact | 2 | . | | 139-266L1 |
| 38 | M39029/56-352 | | Electrical contact | 1 | . | | 139-266L1 |
| 39 | M39029/56-351 | | Electrical contact | 1 | . | | 139-266L1 |
| 40 | MS25036-149 | | Electrical contact | 1 | . | | 139-266L1 |
| 41 | 3G2490LXXXXX | | Integrally lit auxiliary C/B panel | 1 | . | (1) | - |

PART II

| # | P/N | ALTERNATIVE P/N | DESCRIPTION | Q.TY | LVL | NOTE | LOG P/N |
|----|-----------------|-----------------|------------------------------------|------|------|------|-----------|
| 42 | 4G2590F00312 | | KIT BAMBY BUCKET PROVISION | REF | . | | - |
| 43 | 4G2590A02011 | | BAMBY BUCKET COMPLETE PROVISION | REF | .. | | - |
| 44 | 3G5310A20211 | | BAMBI BUCKET STRUCT. PROVISION | REF | ... | | - |
| 45 | 3G5315A40851 | | Support | 1 | | | 139-266L2 |
| 46 | 4G2590A02112 | | BAMBY BUCKET ELECTRICAL PROV | REF | ... | | - |
| 47 | 3G9A01A31301 | | Fire bucket C/A (A1A313) | 1 | | | 139-266L2 |
| 48 | 3G9A01B32301 | | Fire bucket C/A (A1B323) | 1 | | | 139-266L2 |
| 49 | 3G9B01A37401 | | Fire bucket C/A (B1A374) | 1 | | | 139-266L2 |
| 50 | A363A01 | | Terminal | 2 | | | 139-266L2 |
| 51 | A366A3E08C | | Electrical support | 2 | | | 139-266L2 |
| 52 | A366A3E22C | | Electrical support | 1 | | | 139-266L2 |
| 53 | A366A3E22C75 | | Electrical support | 2 | | | 139-266L2 |
| 54 | A649A01 | | Relay | 2 | | | 139-266L2 |
| 55 | ED300GS267 | | Decal | 1 | | | 139-266L2 |
| 56 | ED300GS269 | | Decal | 1 | | | 139-266L2 |
| 57 | ED300J2047 | | Decal | 2 | | | 139-266L2 |
| 58 | ED300K94 | | Decal | 1 | | | 139-266L2 |
| 59 | ED300K95 | | Decal | 1 | | | 139-266L2 |
| 60 | M85049/95-16A-A | | Flange | 2 | | | 139-266L2 |
| 61 | MS21042L3 | | Nut | 5 | | | 139-266L2 |
| 62 | MS21919WDG2 | AS21919WDG02 | Clamp | 2 | | | 139-266L2 |
| 63 | MS21919WDG3 | AS21919WDG03 | Clamp | 3 | | | 139-266L2 |
| 64 | MS3115-16L | | Dummy connector | 1 | | | 139-266L2 |
| 65 | MS3181-16C | MS3181-16CA | Cover | 1 | | | 139-266L2 |
| 66 | MS35206-215 | | Screw | 4 | | | 139-266L2 |
| 67 | NAS1149D0332J | | Washer | 5 | | | 139-266L2 |
| 68 | NAS43DD3-56N | | Spacer | 1 | | | 139-266L2 |
| 69 | NAS43DD3-60N | | Spacer | 2 | | | 139-266L2 |
| 70 | AS21919WDG04 | | Clamp | 2 | . | | 139-266L2 |
| 71 | NAS1149D0432J | | Washer | 8 | . | | 139-266L2 |
| 72 | MS35206-216 | | Screw | 4 | . | | 139-266L2 |
| 73 | A556A-T20 | | Wire | 1m | . | | 139-266L2 |
| 74 | A556A-T22 | | Wire | 1m | . | | 139-266L2 |
| 75 | ED300CB211 | | Decal | 1 | . | | 139-266L2 |
| 76 | ED300S203 | | Decal | 1 | . | | 139-266L2 |
| 77 | MS27722-22 | | Switch | 1 | . | | 139-266L2 |
| 78 | MS3320-7-1/2 | | Circuit Breaker | 1 | . | | 139-266L2 |
| 79 | MS25036-149 | | Pin | 2 | . | | 139-266L2 |
| 80 | M39029/1-100 | | Pin | 2 | . | | 139-266L2 |
| 81 | M39029/56-352 | | Pin | 1 | . | | 139-266L2 |
| 82 | M39029/56-351 | | Pin | 1 | . | | 139-266L2 |
| 83 | 3G2490LXXXXX | | Integrally lit auxiliary C/B panel | 1 | . | (1) | - |

PART III

| # | P/N | ALTERNATIVE P/N | DESCRIPTION | Q.TY | LVL | NOTE | LOG P/N |
|----|--------------|-----------------|----------------------------|------|-----|------|---------|
| 84 | 4G2590F00314 | | KIT BAMBY BUCKET PROVISION | REF | . | | - |
| 85 | 4G2590A02012 | | BAMBY BUCKET | REF | .. | | - |

| # | P/N | ALTERNATIVE P/N | DESCRIPTION | Q.TY | LVL | NOTE | LOG P/N |
|---------------------------|---------------------|------------------|---------------------------------------|------------|------------|------|-----------|
| COMPLETE PROVISION | | | | | | | |
| 86 | 3G5310A20212 | | BAMBI BUCKET STRUCT. PROVISION | REF | ... | | - |
| 87 | 3G5318A07651 | | Support | 1 | | | 139-266L3 |
| 88 | 3G5318A07751 | | Bonding layer | 1 | | | 139-266L3 |
| 89 | NAS1720H4L1A | | Rivet | 3 | | | 139-266L3 |
| 90 | A825A01A-A1 | | Socket support | 1 | | (2) | 139-266L4 |
| 91 | MS35207-260 | | Screw | 4 | | (2) | 139-266L4 |
| 92 | NAS1149D0332J | | Washer | 4 | | (2) | 139-266L4 |
| 93 | NAS1836-3-13 | | Insert | 4 | | (2) | 139-266L4 |
| 94 | 4G2590A02112 | | BAMBY BUCKET ELECTRICAL PROV | REF | ... | | - |
| 95 | 3G9A01A31301 | 3G9A01A31301A10R | Fire bucket C/A (A1A313) | 1 | | | 139-266L3 |
| 96 | 3G9A01B32301 | 3G9A01B32301A10R | Fire bucket C/A (A1B323) | 1 | | | 139-266L3 |
| 97 | 3G9B01A37401 | 3G9B01A37401A10R | Fire bucket C/A (B1A374) | 1 | | | 139-266L3 |
| 98 | A363A01 | | Terminal | 2 | | | 139-266L3 |
| 99 | A366A3E22C | | Stud | 1 | | | 139-266L3 |
| 100 | A366A3E22C75 | | Stud | 2 | | | 139-266L3 |
| 101 | A649A01 | | Relay | 2 | | | 139-266L3 |
| 102 | AW001CB03H | | Clamp | 1 | | | 139-266L3 |
| 103 | AW001CB04H | | Clamp | 2 | | | 139-266L3 |
| 104 | AW001CL001-N6 | | Electrical support | 2 | | | 139-266L3 |
| 105 | ED300GS267 | | Decal | 1 | | | 139-266L3 |
| 106 | ED300GS269 | | Decal | 1 | | | 139-266L3 |
| 107 | ED300J2047 | | Decal | 2 | | | 139-266L3 |
| 108 | ED300K94 | | Decal | 1 | | | 139-266L3 |
| 109 | ED300K95 | | Decal | 1 | | | 139-266L3 |
| 110 | M85049/95-16A-A | | Connector | 2 | | | 139-266L3 |
| 111 | MS21043-3 | | Nut | 3 | | | 139-266L3 |
| 112 | MS3115-16L | | Receptacle | 1 | | | 139-266L3 |
| 113 | MS3181-16C | | Cover | 1 | | | 139-266L3 |
| 114 | MS35206-215 | | Screw | 4 | | | 139-266L3 |
| 115 | MS35206-216 | | Screw | 4 | | | 139-266L3 |
| 116 | NAS1149D0332J | | Washer | 3 | | | 139-266L3 |
| 117 | NAS43DD3-56N | | Spacer | 1 | | | 139-266L3 |
| 118 | NAS43DD3-60N | | Spacer | 2 | | | 139-266L3 |
| 119 | 3G2490LXXXXX | | Integrally lit auxiliary C/B panel | 1 | . | (1) | - |
| 120 | MS3320-7-1/2 | | Circuit Breaker | 1 | . | | 139-266L3 |
| 121 | ED300CB211 | | Decal | 1 | . | | 139-266L3 |
| 122 | ED300S203 | | Decal | 1 | . | | 139-266L3 |
| 123 | MS27722-22 | | Switch | 1 | . | | 139-266L3 |
| 124 | A556A-T22 | | Wire | 1m | . | | 139-266L3 |
| 125 | A556A-T20 | | Wire | 2.5m | . | | 139-266L3 |
| 126 | MS25036-149 | | Pin | 2 | . | | 139-266L3 |
| 127 | M39029/56-352 | | Pin | 1 | . | | 139-266L3 |
| 128 | M39029/1-100 | | Pin | 2 | . | | 139-266L3 |
| 129 | M39029/56-351 | | Pin | 1 | . | | 139-266L3 |

Refer also to IPD for the spares materials required to comply with the AMP DMs referenced in the accomplishment instructions.

CONSUMABLES

The following consumable materials, or equivalent, are necessary to accomplish this Service Bulletin:

| # | SPEC./LHD CODE NUMBER | DESCRIPTION | Q.TY | NOTE | PART |
|-----|---|----------------------------|------|------|------------|
| 130 | MMM-A-132 Type I, Class 3 Code No. 900004603 199-05-002, Type II, Class 2 | Adhesive EA934NA (C057) | AR | (3) | I, II, III |
| 131 | MMM-A-132, Type II, Class 2 Code No. 900000581 199-05-002 Type I, Class 2 | Adhesive EA9309.3NA (C021) | AR | (3) | I, II, III |
| 132 | Commercial | Adhesive CB200-40 (C356) | AR | (3) | III |

Refer also to AMDI for the consumable materials required to comply with the AMP DM referenced in the accomplishment instructions.

LOGISTIC MATRIX

In order to apply this Service Bulletin, the following Logistic P/N can be ordered in accordance with the applicable notes:

| LOGISTIC P/N | Q.TY (PER HELO) | NOTE | PART |
|--------------|-----------------|------|------------|
| 139-266L1 | 1 | | I |
| 139-266L2 | 1 | | II |
| 139-266L3 | 1 | | III |
| 139-266L4 | 1 | (2) | III |
| 3G2490LXXXXX | 1 | (1) | I, II, III |

NOTE

- (1) The P/N is not properly completed because it is depending on the helicopter configuration. Customers must contact Product Support Engineering (engineering.support.lhd@leonardocompany.com) to request the new auxiliary CB panel at least three months in advance from the scheduled application of this Service Bulletin.
- (2) Item to be supplied only if support P/N 3G5310A01915 is NOT already installed as part of the structural provisions for one of the SX16 or Trakka search light kits.
- (3) Item to be procured as local supply.

B. SPECIAL TOOLS

N.A.

C. INDUSTRY SUPPORT INFORMATION

Customization.

3. ACCOMPLISHMENT INSTRUCTIONS

GENERAL NOTES

- a) Place an identification tag on all components that are re-usable, including the attaching hardware that has been removed to gain access to the modification area and adequately protect them until their later re-use.
- b) Shape the cables in order to prevent interference with the structure and the other existing installations, using where necessary suitable lacing cords and plastic cable tiedown.
- c) Exercise extreme care during drilling operations to prevent instruments, cables and hoses damage.
- d) After drilling, remove all swarf and sharp edges. Apply on bare metal a light film of primer unless the hole is used for ground connection.
- e) During the installation of bonding braids or components requiring grounding, clean the surface structure in order to obtain a good ground contact.
- f) Let adhesive cure at room temperature for at least 24 hours unless otherwise specified.
- g) Exposed thread surface and nut must be protected using a layer of tectyl according to MIL-C-16173 grade I.
- h) All lengths are in mm.

PART I

1. In accordance with DM 39-A-00-20-00-00A-120A-A, prepare the helicopter on ground for a safe maintenance. Disconnect the battery, all electrical power sources and/or the external power supply.
2. With reference to Figures 2, gain access to the area affected by the installation and perform Bambi Bucket Structural Provision P/N 3G5310A20211 as described in the following procedure:
 - 2.1 With reference to Figure 2 Section C-C, perform the indicated cut-out on the lower panel P/N 3P5331A02231 through internal skin and honeycomb without removing external skin. Coordinate it with support P/N 3G5315A40851.

- 2.2 With reference to Figure 2 Section C-C and Detail A seal the cut-out with adhesive EA934NA.
- 2.3 With reference to Figure 2 Detail A, bond the support P/N 3G5315A40851 by means of adhesive EA934NA.
- 2.4 With reference to Figure 2 Detail B, drill n°8 holes Ø 3.25 through lower panel P/N 3P5331A02231 in indicated positions.
- 2.5 With reference to Figure 2 Detail B, drill Ø 28.0 through external skin of lower panel P/N 3P5331A02231 in accordance with support P/N 3G5315A40851.
3. Perform the Bambi Bucket Electrical Provision as described in the following procedure:
 - 3.1 With reference to Figure 3, remove and discard the existing pilot cyclic stick assy P/N 3G6712A00733.
 - 3.2 With reference to Figure 3, remove and discard the existing co-pilot cyclic stick assy P/N 3G6712A00833.
 - 3.3 With reference to Figure 4 Section DA-DA, drill n°4 holes Ø11.48÷11.61 and install n°4 inserts P/N NAS1836-3-13 by means of adhesive EA934NA; coordinate inserts position with bracket holes.
 - 3.4 With reference to Figure 4 Detail D2, install bracket P/N A824A01A-A1 by means of n°4 screws P/N MS35207-260 and n°4 washers P/N NAS1149D0332J.
 - 3.5 With reference to Figure 4 Detail E2, install the electrical support P/N A366A3E08C in the indicated position by means of adhesive EA9309.3NA.
 - 3.6 With reference to Figure 4 Detail E2, install the electrical support P/N A366A3E20C in the indicated position by means of adhesive EA9309.3NA.

NOTE

If necessary, the use of clamps of different size as alternative to indicated ones is allowed.

- 3.7 With reference to Figure 4 Detail E2, install a clamp P/N AS21919WDG05 in indicated position by means of a washer P/N NAS1149D0332J and a nut P/N MS21042L3.
- 3.8 With reference to Figure 4 Detail E2, install a clamp P/N AS21919WDG05 in indicated position by means of a spacer P/N NAS43DD3-40N, a washer P/N NAS1149D0332J and a nut P/N MS21042L3.
- 3.9 With reference to Figure 4 Detail D1, install n°2 relay P/N A649A01 on the previously installed bracket; apply decals P/N ED300K94 and P/N ED300K95 in an adjacent area.
- 3.10 With reference to Figure 4 Detail D1, install a ground stud P/N A363A01 in the indicated position; apply decals P/N ED300GS55 in an adjacent area.

- 3.11 With reference to Figure 4 Detail E1, install a flange P/N M85049/95-16A-A by means of n°4 screws P/N MS35206-216 and n°4 washers P/N NAS1149DN416J; apply decal P/N ED300J137 in an adjacent area.
 - 3.12 With reference to Figure 4 Detail E1, install in indicated position a dummy connector P/N MS3115-16L and relevant cover P/N MS3181-16CA by means of a flange P/N M85049/95-16A-A, n°4 screws P/N MS35206-215 and n°4 washers NAS1149DN416J.
 - 3.13 With reference to Figures 3, 4 and 5, route the following cable assemblies:
 - 3G9A01B32301 Cable assy (B1A139)
 - 3G9B01A37401 Cable assy (B1A188)
 - 3G9A01A31301 Cable assy (C1A110)
 - 3G9A01A31301 Cable assy (C1B112)secure the cable by means of existing hardware and lacing cord.
 - 3.14 With reference to Figure 6 Wiring Diagram, perform electrical connection of the cable B1B139 to sectioning connectors A58J1 and P16.
 - 3.15 With reference to Figure 6 Wiring Diagram, perform electrical connection of the cable B1A188 to sectioning connectors A59J1, J7 and J16 and to circuit breaker panel connectors PL1P7 and PL1P3.
 - 3.16 With reference to Figure 7 Wiring Diagram, perform electrical connection of the cable B1B139 to sectioning connectors J137 and P7 and to ground stud GS55.
 - 3.17 With reference to Figure 8 Wiring Diagram, perform electrical connection of the cable C1B112 between MAU2 connector A2-1P2 and sectioning connectors J102 and P125.
 - 3.18 With reference to Figure 8 Wiring Diagram, perform electrical connection of the cable C1A110 between the MAU1 connector A1-1P2 and sectioning connector J125.
 - 3.19 With reference to Figure 8 Wiring Diagram, perform electrical connection of the cable B1B139 to sectioning connector P102.
 - 3.20 With reference to Figure 3, install the new pilot cyclic stick assy P/N 3G6712A00737.
 - 3.21 With reference to Figure 3, install the new co-pilot cyclic stick assy P/N 3G6712A00837.
4. Modify the Auxiliary C/B panel on the overhead panel, as described in the following procedure:

NOTE

Customer must contact LHD PSE (engineering.support.lhd@leonardocompany.com) at least 3 months in advance of embodiment date of this Service Bulletin in order to collect the exact W/D applicable to helicopter configuration.

- 4.1 With reference to AMP DM 39-A-24-91-04-00A-920A-K remove from the overhead Auxiliary C/B panel the existing Integrally-lit panel; replace it with the new one.
- 4.2 Install where indicated on the new Integrally-lighted panel one Circuit Breaker P/N MS3320-7-1/2 for Bambi Bucket system.
- 4.3 Install decal ED300CB211 adjacent to the Circuit Breaker previously installed.
- 4.4 Install where indicated on the new Integrally-lighted panel one switch P/N MS27722-22 for Bambi Bucket system.
- 4.5 Install decal ED300S203 adjacent to the switch previously installed.
- 4.6 With reference to Figure 6 Wiring Diagram, perform the electrical connection between pin 2 of CB211 and pin Z of connector PL1J7 by means of A556A-T16 wire. Use electrical contact P/N MS25036-153 for pin 2 of CB211 and electrical contact P/N M39029/56-352 for pin Z of PL1J7. CB211 has to be connected to 28V DC MAIN BUS 2 W22C.
- 4.7 With reference to Figure 6 Wiring Diagram, perform the electrical connection between pin 2 of CB211 and pin 2 of switch S203 by means of A556A-T20 wire. Use electrical contact P/N MS25036-149 for pin 2 of CB211 and electrical contact P/N M39029/1-16-20 for pin 2 of S203.
- 4.8 With reference to Figure 6 Wiring Diagram, perform the electrical connection between pin 3 of switch S203 and pin v of PL1J3 by means of A556A-T20 wire. Use electrical contact P/N M39029/1-16-20 for pin 3 of s203 and electrical contact P/N M39029/56-351 for pin v of PL1J3.
5. Perform a pin-to-pin continuity check of all the electrical connections made.
6. In accordance with weight and balance changes, update the Chart A (see Rotorcraft Flight Manual, Part II, section 6)
7. Return the helicopter to flight configuration and record for compliance with Part I of this Service Bulletin on the helicopter logbook.
8. Gain access to My Communications section on Leonardo WebPortal and compile the "Service Bulletin Application Communication".

As an alternative, send the attached compliance form to the following mail box:

engineering.support.lhd@leonardo.com

and (for North, Central and South America) also to:

AWPC.Engineering.Support@leonardocompany.us

PART II

1. In accordance with DM 39-A-00-20-00-00A-120A-A, prepare the helicopter on ground for a safe maintenance. Disconnect the battery, all electrical power sources and/or the external power supply.
2. With reference to Figures 2, gain access to the area affected by the installation and perform Bambi Bucket Structural Provision P/N 3G5310A20211 as described in the following procedure:
 - 2.1 With reference to Figure 2 Section C-C, perform the indicated cut-out on the lower panel P/N 3P5331A02231 through internal skin and honeycomb without removing external skin. Coordinate it with support P/N 3G5315A40851.
 - 2.2 With reference to Figure 2 Section C-C and Detail A seal the cut-out with adhesive EA934NA.
 - 2.3 With reference to Figure 2 Detail A, bond the support P/N 3G5315A40851 by means of adhesive EA934NA.
 - 2.4 With reference to Figure 2 Detail B, drill n°8 holes Ø 3.25 through lower panel P/N 3P5331A02231 in indicated positions.
 - 2.5 With reference to Figure 2 Detail B, drill Ø 28.0 through external skin of lower panel P/N 3P5331A02231 in accordance with support P/N 3G5315A40851.
3. Perform the Bambi Bucket Electrical Provision P/N 4G2590A02111 as described in the following procedure:
 - 3.1 With reference to Figure 9, install an electrical support P/N A366A3E22C in the indicated position by means of adhesive EA9309.3NA.
 - 3.2 With reference to Figure 9, install n°2 electrical supports P/N A366A3E08C in the indicated positions by means of adhesive EA9309.3NA.
 - 3.3 With reference to Figure 9, install n°2 electrical supports P/N A366A3E22C75 in the indicated positions by means of adhesive EA9309.3NA.
 - 3.4 With reference to Figure 9, install a clamp P/N AS21919WDG03 by means of a spacer P/N NAS43DD3-56N, a washer P/N NAS1149D0332J and nut P/N MS21042L3.
 - 3.5 With reference to Figure 9, install n°2 clamps P/N AS21919WDG03 by means of n°2 washers P/N NAS1149D0332J and n°2 nuts P/N MS21042L3.

NOTE

If necessary, the use of clamps of different size as alternative to indicated ones is allowed.

- 3.6 With reference to Figure 9, install n°2 clamps P/N AS21919WDG02 by means of n°2 spacers P/N NAS43DD3-60N, n°2 washers P/N NAS1149D0332J and n°2

- nuts P/N MS21042L3.
- 3.7 With reference to Figure 9, install on existing bracket n°2 relay P/N A649A01; apply decals P/N ED300K94 and P/N ED300K95 in an adjacent area.
 - 3.8 With reference to Figure 9, install n°2 ground stud P/N A363A01 in the indicated positions; apply decals P/N ED300GS267 and P/N ED300GS269 in an adjacent area.
 - 3.9 With reference to Figure 9, install a flange P/N M85049/95-16A-A by means of n°4 screws P/N MS35206-216, n°4 washers P/N NAS1149D0432J; apply decal P/N ED300J2047 in an adjacent area.
 - 3.10 With reference to Figure 9, install in indicated position a dummy connector P/N MS3115-16L by means of n°4 screws P/N MS35206-215, n°4 washers NAS1149D0432J; install a cover P/N MS3181-16CA.
 - 3.11 With reference to Figure 9, apply decal P/N ED300J2047 in an adjacent area to connector J2047.
 - 3.12 With reference to Figures 9 and 10, route the following cable assemblies:
 - 3G9A01A31301 Cable assy (A1A313)
 - 3G9A01B32301 Cable assy (A1B323)
 - 3G9B01A37401 Cable assy (B1A374)
 - 3.13 With reference to Figure 10 and Figures 11 and 12 Wiring Diagram, perform electrical connection of the cable A1B323 between MAU2 connector A2-1P2 and sectioning connector P101, following indicated route. Secure the cable by means of existing hardware.
 - 3.14 With reference to Figures 11 and 12 Wiring Diagram, perform electrical connection of the cable A1A313 between the MAU1 connector A1-1P2 and sectioning connectors J101 and P117, following indicated route; secure the cable by means of existing hardware and lacing cord.
 - 3.15 With reference to Figures 11 and 12 Wiring Diagram, perform electrical connection of the cable A1B323 between sectioning connectors P109, P111 and pilot cyclic connector A58J1, following indicated route; secure the cable by means of existing hardware.
 - 3.16 With reference to Figures 11 and 12 Wiring Diagram, perform electrical connection of the cable A1A313 between sectioning connectors J109, P117 and co-pilot cyclic connector A59J1, following indicated route; secure the cable by means of existing hardware.
 - 3.17 With reference to Figures 11 and 12 Wiring Diagram, perform electrical connection of the cable A1A313 between sectioning connectors J111, P117 and co-pilot cyclic

- connector A59J1, following indicated route; secure the cable by means of existing hardware.
- 3.18 With reference to Figures 11 and 12 Wiring Diagram, perform electrical connection of the cable B1A374 between sectioning connector J117, circuit breaker panel connector PL1P9 and relay connectors K94P1 and K95P1 following indicated route; secure the cable by means of existing hardware.
 - 3.19 With reference to Figures 11 and 12 Wiring Diagram, perform electrical connection of the cable B1A374 between relay connectors K94P1, K95P1 and ground stud GS267. Secure the cable by means of existing hardware.
 - 3.20 With reference to Figures 11 and 12 Wiring Diagram, perform electrical connection of the cable B1A374 between relay connector K95P1, connector J2047 and ground stud GS269. Secure the cable by means of existing hardware.
 - 3.21 With reference to Figures 11 and 12 Wiring Diagram, perform electrical connection of the cable B1A374 between relay connector K94P1 and circuit breaker panel connector PL1P7 following indicated route; secure the cable by means of existing hardware.
4. Modify the Auxiliary C/B panel on the overhead panel, as described in the following procedure:

NOTE

Customer must contact LHD PSE
(engineering.support.lhd@leonardocompany.com) at
least 3 months in advance of embodiment date of this
Service Bulletin in order to collect the exact W/D
applicable to helicopter configuration.

- 4.1 With reference to AMP DM 39-A-24-91-04-00A-920A-K remove from the overhead Auxiliary C/B panel the existing Integrally-lit panel; replace it with the new one.
- 4.2 Install where indicated on the new Integrally-lighted panel one Circuit Breaker P/N MS3320-7-1/2 for Bambi Bucket system.
- 4.3 Install decal ED300CB211 adjacent to the Circuit Breaker previously installed.
- 4.4 Install where indicated on the new Integrally-lighted panel one switch P/N MS27722-22 for Bambi Bucket system.
- 4.5 Install decal ED300S203 adjacent to the switch previously installed.
- 4.6 Perform electrical connection between CB211 pin 2 and connector of the auxiliary circuit breaker panel PL1J7 pin H using A556A-T20 wire. Use pin P/N MS25036-149 for pin 2 of CB211 and pin P/N M39029/56-352 for pin H of connector PL1J7. CB211 has to be connected to 28V DC MAIN BUS 2 W22C.

- 4.7 Perform electrical connection between CB211 pin 2 and switch S203 pin 2 using A556A-T22 wire. Use pin P/N MS25036-149 for pin 2 of CB211 and pin P/N M39029/1-100 for pin 2 of switch S203.
- 4.8 Perform electrical connection between switch S203 pin 3 and connector of the auxiliary circuit breaker panel PL1J9 pin w using A556A-T22 wire. Use pin P/N M39029/1-100 for pin 3 of switch S203 and pin P/N M39029/56-351 for pin w of connector PL1J9.
5. Perform a pin-to-pin continuity check of all the electrical connections made.
6. In accordance with weight and balance changes, update the Chart A (see Rotorcraft Flight Manual, Part II, section 6).
7. Return the helicopter to flight configuration and record for compliance with Part II of this Service Bulletin on the helicopter logbook.
8. Gain access to My Communications section on Leonardo WebPortal and compile the "Service Bulletin Application Communication".

As an alternative, send the attached compliance form to the following mail box:

engineering.support.lhd@leonardo.com

and (for North, Central and South America) also to:

AWPC.Engineering.Support@leonardocompany.us

PART III

1. In accordance with DM 39-A-00-20-00-00A-120A-A, prepare the helicopter on ground for a safe maintenance. Disconnect the battery, all electrical power sources and/or the external power supply.
2. In accordance with DM 39-A-06-41-00-00A-010A-A and with reference to Figure 13, gain access to the area affected by the installation and perform Bambi Bucket Structural Provision P/N 3G5310A20212 as described in the following procedure:

NOTE

Perform following steps 2.1, 2.2 and 2.3 only if support P/N 3G5310A01915 is NOT already installed in the same position as that of P/N A825A01A-A1 in Figure 13 top view.

- 2.1 With reference to Figure 13 Section A-A, temporarily locate the support P/N A825A01A-A1 on the rear lower bonded panel P/N 3G5331A40831, countermark and drill n°4 holes \varnothing 11.48-11.61 through rear lower bonded panel.
- 2.2 With reference to Figure 13 Section A-A, install n°4 inserts P/N NAS1836-3-13 by means of adhesive EA934NA (C057).
- 2.3 With reference to Figure 13 Section A-A, install the support P/N A825A01A-A1 on the rear lower bonded panel by means of n°4 screws P/N MS35207-260 and n°4 washers P/N NAS1149D0332J.
- 2.4 With reference to Figure 13 Section C-C and Detail B, temporarily locate the support P/N 3G5318A07651 on the rear lower bonded panel, countermark and drill n°1 hole $28.06 \div 28.32$ and n°8 holes \varnothing $3.12 \div 3.38$ thru external skin in indicated positions.
- 2.5 With reference to Figure 13 Section C-C, bond the support P/N 3G5318A07651 by means of adhesive EA934NA (C057) and adhesive EA9309.3NA (C021) as indicated.
- 2.6 In accordance with AMP DM 39-A-20-10-01-00A-259A-A and Figure 13 Detail B, prepare indicated surface for good electrical bonding.
- 2.7 With reference to Figure 13 Detail B, install the bonding layer P/N 3G5318A07751 on the support P/N 3G5318A07651 and on the rear lower bonded panel by means of adhesive EA9309.3NA (C021) and n°3 rivets P/N NAS1720H4L1A.
3. Perform the Bambi Bucket Electrical Provision P/N 4G2590A02112 as described in the following procedure:
 - 3.1 With reference to Figure 16 View looking floor area LH side, install an electrical support P/N A366A3E22C in the indicated position by means of adhesive

- CB200-40 (C356).
- 3.2 With reference to Figure 16 View looking floor area LH side, install n°2 electrical supports P/N AW001CL001-N6 in the indicated positions by means of adhesive CB200-40 (C356).
 - 3.3 With reference to Figure 16 View looking floor area LH side, install n°2 electrical supports P/N A366A3E22C75 in the indicated positions by means of adhesive CB200-40 (C356).
 - 3.4 With reference to Figure 16 View looking floor area LH side, install a clamp P/N AW001CB03H by means of a spacer P/N NAS43DD3-56N, a washer P/N NAS1149D0332J and nut P/N MS21043-3.

NOTE

If necessary, the use of clamps of different size as alternative to indicated ones is allowed.

- 3.5 With reference to Figure 16 View looking floor area LH side, install n°2 clamps P/N AW001CB04H by means of n°2 spacers P/N NAS43DD3-60N, n°2 washers P/N NAS1149D0332J and n°2 nuts P/N MS21043-3.
- 3.6 With reference to Figure 16 View looking floor area LH side, install on support P/N A825A01A-A1 (or support P/N 3G5310A01915 if this was already installed) n°2 relays P/N A649A01.
- 3.7 In accordance with AMP DM 39-A-11-00-01-00A-720A-A and with reference to Figure 16 View looking floor area LH side, apply decals P/N ED300K94 and P/N ED300K95 near the previously installed n°2 relays P/N A649A01.
- 3.8 With reference to Figure 16 View looking floor area LH side, install n°2 ground studs P/N A363A01 in the indicated positions.
- 3.9 In accordance with AMP DM 39-A-11-00-01-00A-720A-A and with reference to Figure 16 View looking floor area LH side, apply decals P/N ED300GS267 and P/N ED300GS269 near the ground studs P/N A363A01.
- 3.10 With reference to Figure 16 View looking up on external skin, install in indicated position the flange P/N M85049/95-16A-A and the dummy connector P/N MS3115-16L by means of n°4 screws P/N MS35206-215.
- 3.11 With reference to Figure 16 View looking up on external skin, install the cover P/N MS3181-16C on the dummy connector P/N MS3115-16L.

NOTE

Use the edging P/N A236A on edges which are liable to cause damage to cable assemblies or where abrasion may occur.

NOTE

Install the tubing braided P/N A582A where protection against chafing and prevention of contact with structure may occur.

- 3.12 With reference to Figures 15 and 16, route the following cable assemblies:
 - 3G9A01A31301 Cable assy (A1A313)
 - 3G9A01B32301 Cable assy (A1B323)
 - 3G9B01A37401 Cable assy (B1A374)
- 3.13 With reference to Figures 15 and 16, secure the cable assemblies lay down at the previous step by means of existing hardware and lacing cords.
- 3.14 With reference to Figure 16 View looking floor area LH side, install the connector J2047 and the flange P/N M85049/95-16A-A on the bonding layer P/N 3G5318A07751 by means of n°4 screws P/N MS35206-216.
- 3.15 In accordance with AMP DM 39-A-11-00-01-00A-720A-A and with reference to Figure 16 View looking floor area LH side and View looking up on external skin, apply n°2 decals P/N ED300J2047 near the connector J2047.
- 3.16 In accordance with AMP DM 39-A-20-10-08-00A-622A-A and reference to Figure 15 and Figure 17 Wiring Diagram, perform electrical connection of the cable A1B323 between MAU2 connector A2-1P2 and sectioning connector P101.
- 3.17 In accordance with AMP DM 39-A-20-10-08-00A-622A-A and reference to Figures 15 and 17 Wiring Diagram, perform electrical connection of the cable A1A313 between the MAU1 connector A1-1P2 and sectioning connectors J101 and P117.
- 3.18 In accordance with AMP DM 39-A-20-10-08-00A-622A-A and reference to Figure 15 and Figure 17 Wiring Diagram, perform electrical connection of the cable A1B323 between sectioning connectors P109, P111 and pilot cyclic connector A58J1.
- 3.19 In accordance with AMP DM 39-A-20-10-08-00A-622A-A and reference to Figure 15 and Figure 17 Wiring Diagram, perform electrical connection of the cable A1A313 between sectioning connectors J111, J109, P117 and co-pilot cyclic connector A59J1.
- 3.20 In accordance with AMP DM 39-A-20-10-08-00A-622A-A and with reference to Figures 15 and 16, and Figure 17 and 18 Wiring Diagram, perform electrical

- connection of the cable B1A374 between sectioning connector J117, circuit breaker panel connector PL1P9 and relay connectors K94P1 and K95P1.
- 3.21 In accordance with AMP DM 39-A-20-10-08-00A-622A-A and with reference to Figure 16 and Figure 18 Wiring Diagram, perform electrical connection of the cable B1A374 between relay connectors K94P1, K95P1 and ground stud GS267.
 - 3.22 In accordance with AMP DM 39-A-20-10-08-00A-622A-A and with reference to Figure 16 and Figure 18 Wiring Diagram, perform electrical connection of the cable B1A374 between relay connector K95P1, connector J2047 and ground stud GS269.
 - 3.23 In accordance with AMP DM 39-A-20-10-08-00A-622A-A and with reference to Figures 15 and 16, and Figure 18 Wiring Diagram, perform electrical connection of the cable B1A374 between relay connector K94P1 and circuit breaker panel connector PL1P7.
4. Modify the Auxiliary C/B panel on the overhead panel, as described in the following procedure:

NOTE

Customer must contact LHD PSE
(engineering.support.lhd@leonardocompany.com) at
least 3 months in advance of embodiment date of this
Service Bulletin in order to collect the exact W/D
applicable to helicopter configuration.

- 4.1 With reference to AMP DM 39-A-24-91-04-00A-920A-K remove from the overhead Auxiliary C/B panel the existing Integrally-lit panel; replace it with the new one.
- 4.2 Install where indicated on the new Integrally-lighted panel one Circuit Breaker P/N MS3320-7-1/2 for Bambi Bucket system.
- 4.3 Install decal ED300CB211 adjacent to the Circuit Breaker previously.
- 4.4 Install where indicated on the new Integrally-lighted panel one switch P/N MS27722-22 for Bambi Bucket system.
- 4.5 Install decal ED300S203 adjacent to the switch previously installed.
- 4.6 Perform electrical connection between CB211 pin 2 and connector of the auxiliary circuit breaker panel PL1J7 pin H using A556A-T20 wire. Use pin P/N MS25036-149 for pin 2 of CB211 and pin P/N M39029/56-352 for pin H of connector PL1J7. CB211 has to be connected to 28V DC MAIN BUS 2 W22C.
- 4.7 Perform electrical connection between CB211 pin 2 and switch S203 pin 2 using A556A-T22 wire. Use pin P/N MS25036-149 for pin 2 of CB211 and pin P/N M39029/1-100 for pin 2 of switch S203.

- 4.8 Perform electrical connection between switch S203 pin 3 and connector of the auxiliary circuit breaker panel PL1J9 pin w using A556A-T22 wire. Use pin P/N M39029/1-100 for pin 3 of switch S203 and pin P/N M39029/56-351 for pin w of connector PL1J9.
5. Perform a pin-to-pin continuity check of all the electrical connections made.
6. In accordance with AMP DM 39-A-06-41-00-00A-010A-A, re-install all external panels, internal panels and internal liners previously removed.
7. In accordance with weight and balance changes, update the Chart A (see Rotorcraft Flight Manual, Part II, section 6).
8. Return the helicopter to flight configuration and record for compliance with Part III of this Service Bulletin on the helicopter logbook.
9. Gain access to My Communications section on Leonardo WebPortal and compile the "Service Bulletin Application Communication".

As an alternative, send the attached compliance form to the following mail box:

engineering.support.lhd@leonardo.com

and (for North, Central and South America) also to:

AWPC.Engineering.Support@leonardocompany.us

4G2590F00311
KIT BAMBY BUCKET PROVISION

APPLICABLE TO HELICOPTERS:
FROM S/N 31001 TO S/N 31157
FROM S/N 41001 TO S/N 41023
(FIGURES 3 TO 5)

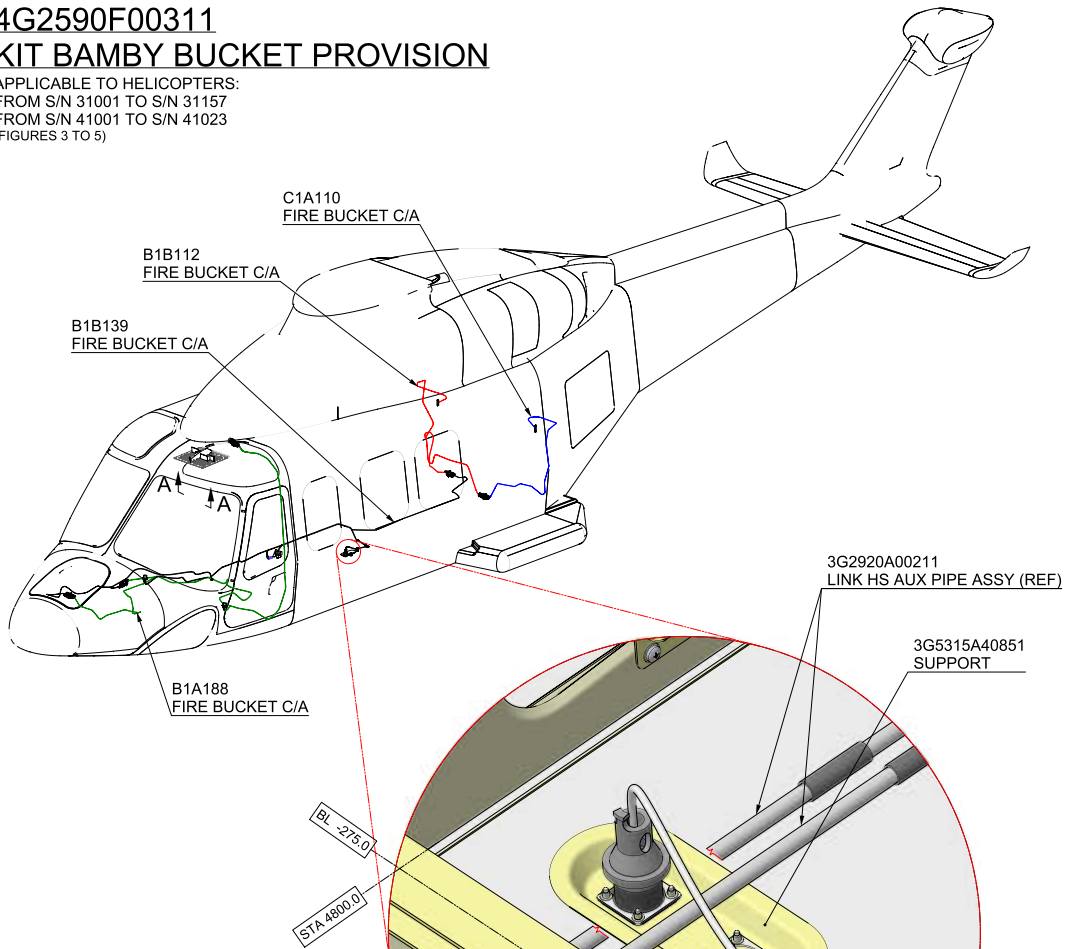

4G2590A02011
STRUCTURAL
PROVISION

(FIGURE 2)

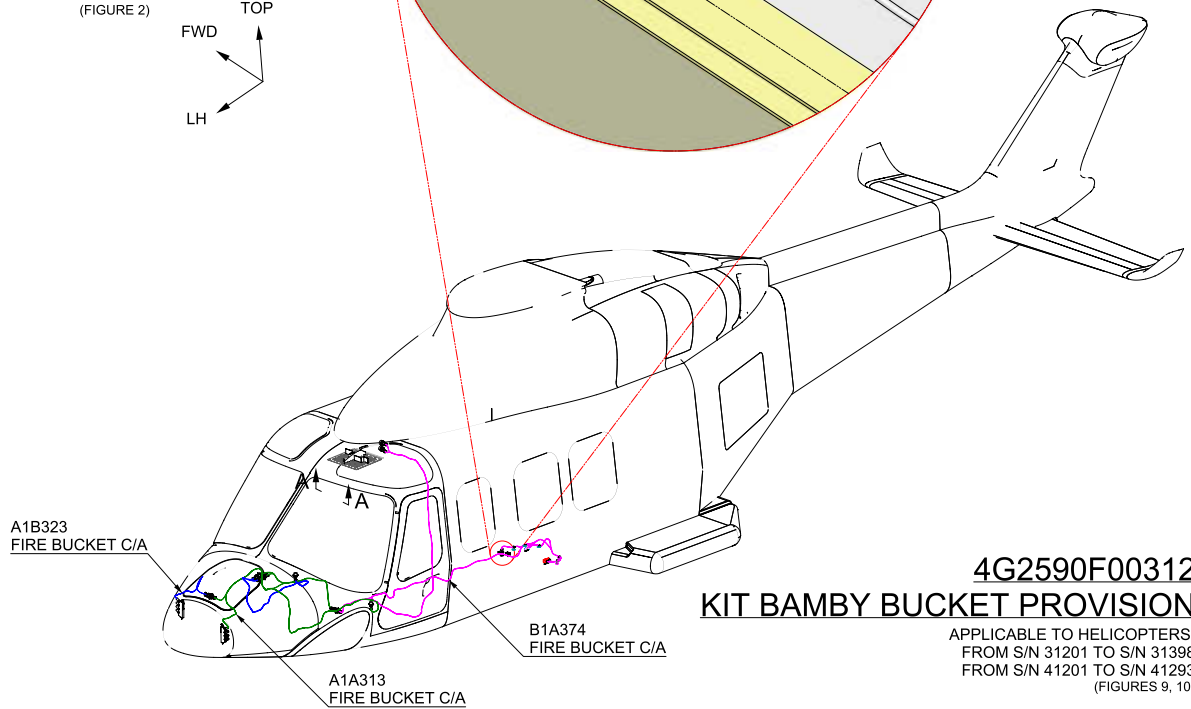
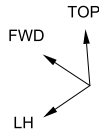

4G2590F00312

KIT BAMBY BUCKET PROVISION

APPLICABLE TO HELICOPTERS:
FROM S/N 31201 TO S/N 31398
FROM S/N 41201 TO S/N 41293
(FIGURES 9, 10)

10.

Figure 1

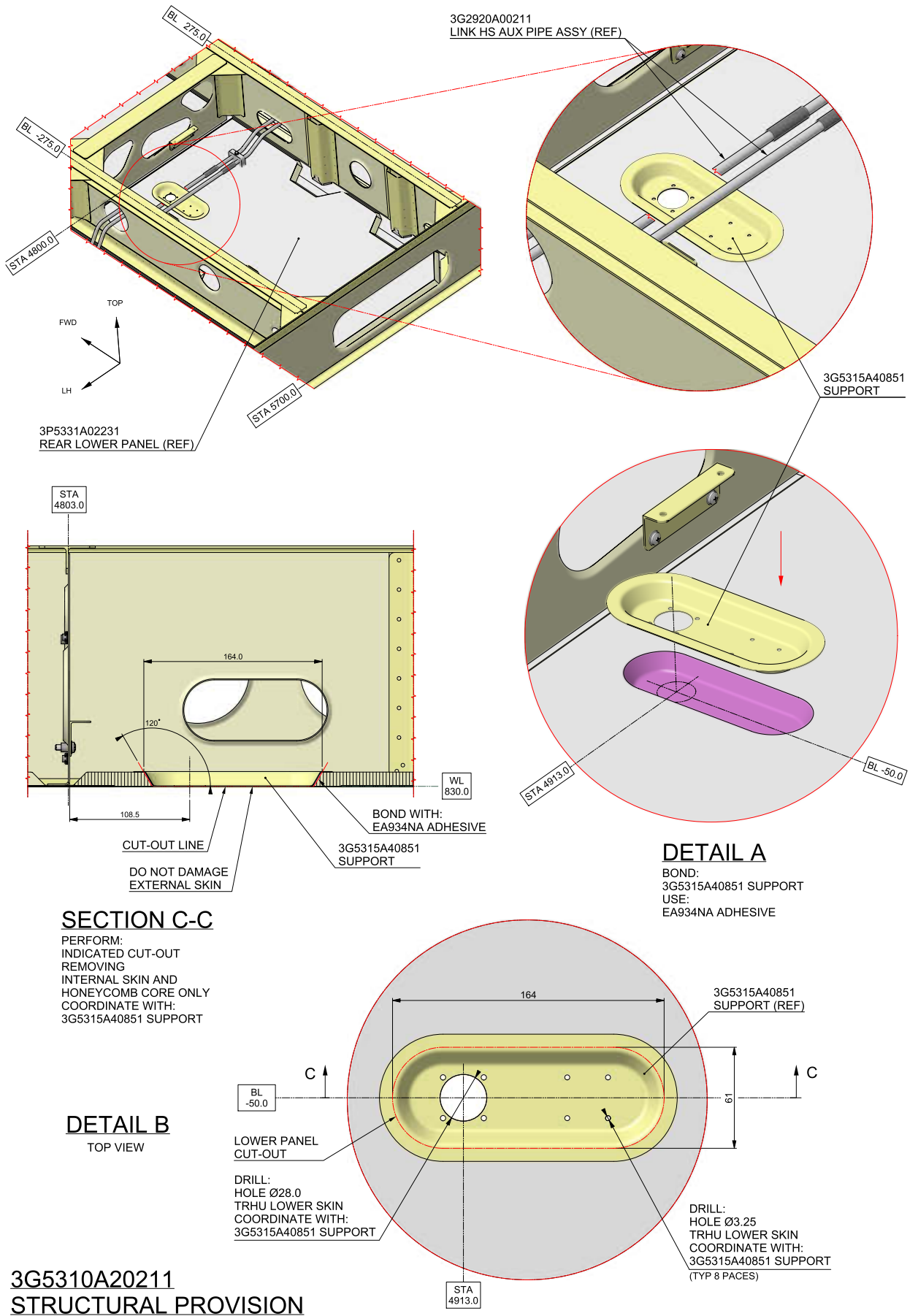

Figure 2

S.B. N°139-266 OPTIONAL
DATE: October 7, 2011
REVISION: B - June 20, 2023

4G2590F00311 KIT BAMBY BUCKET PROVISION

APPLICABLE TO HELICOPTERS:
FROM S/N 31001 TO S/N 31157
FROM S/N 41001 TO S/N 41023

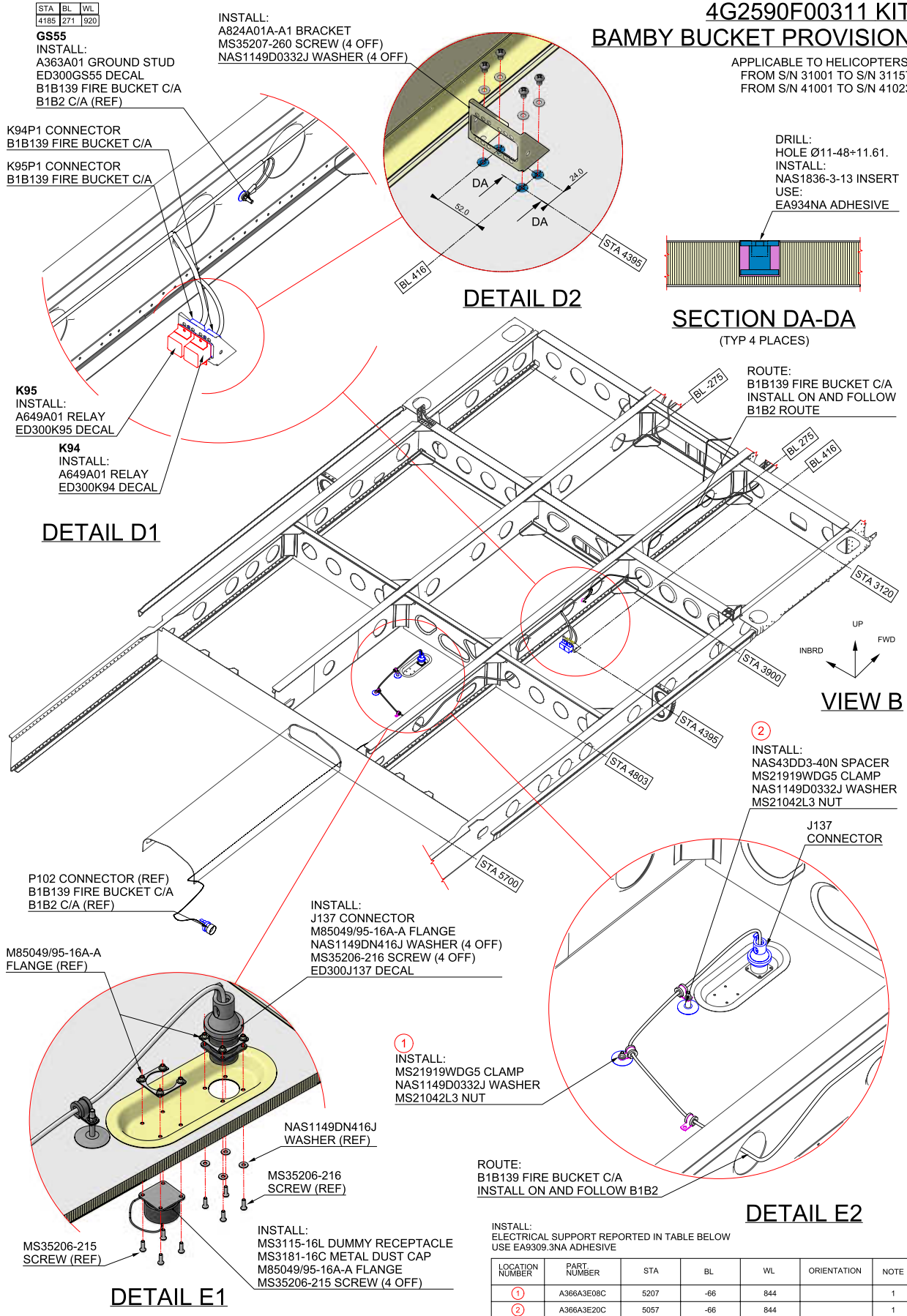

Figure 4

S.B. N°139-266 OPTIONAL
DATE: October 7, 2011
REVISION: B - June 20, 2023

4G2590F00311
KIT BAMBY BUCKET PROVISION

APPLICABLE TO HELICOPTERS:
FROM S/N 31001 TO S/N 31157
FROM S/N 41001 TO S/N 41023

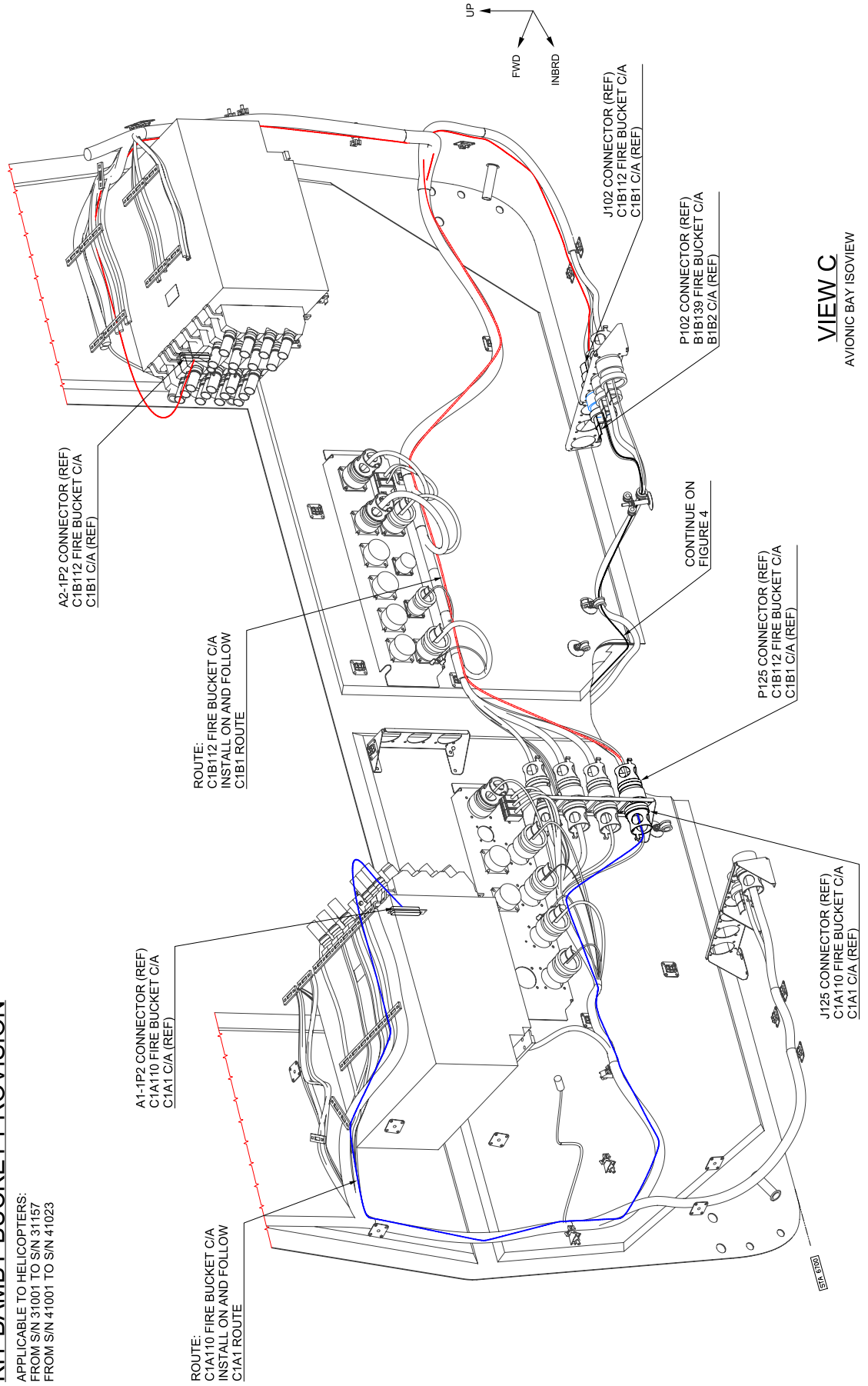

Figure 5

DRAWING REF. KEY
 SHEET NO. 2

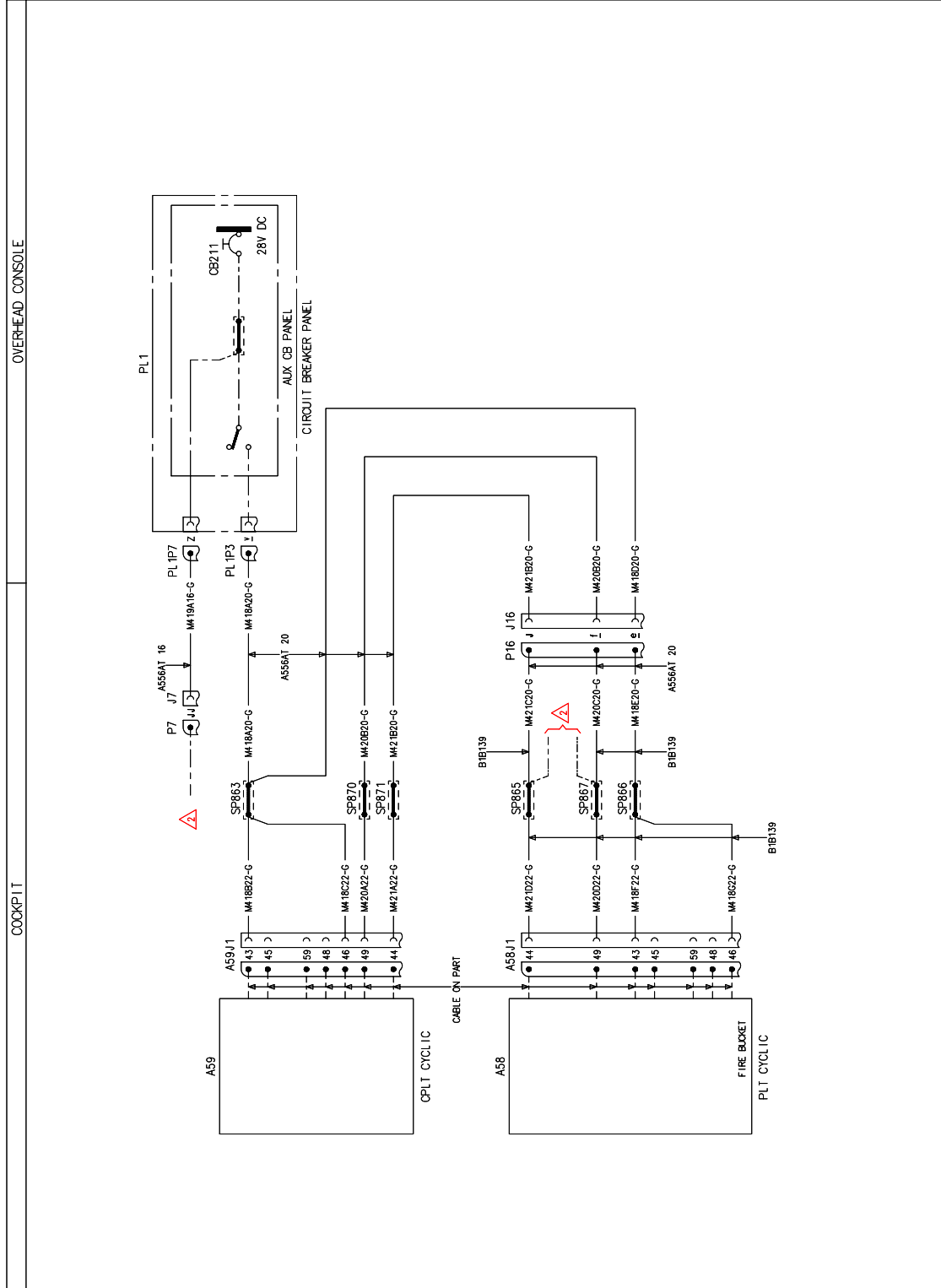

Figure 6

S.B. N°139-266 OPTIONAL
 DATE: October 7, 2011
 REVISION: B - June 20, 2023

FUNCTIONAL NOTES

ALL CABLES ARE IN LOOM B1A188 UNLESS SPECIFIED.
 ALL CABLES ARE OF TYPE ASS041 22 UNLESS SPECIFIED.

DRAWING REF. KEY

△ SHEET NO. 1

△ SHEET NO. 3

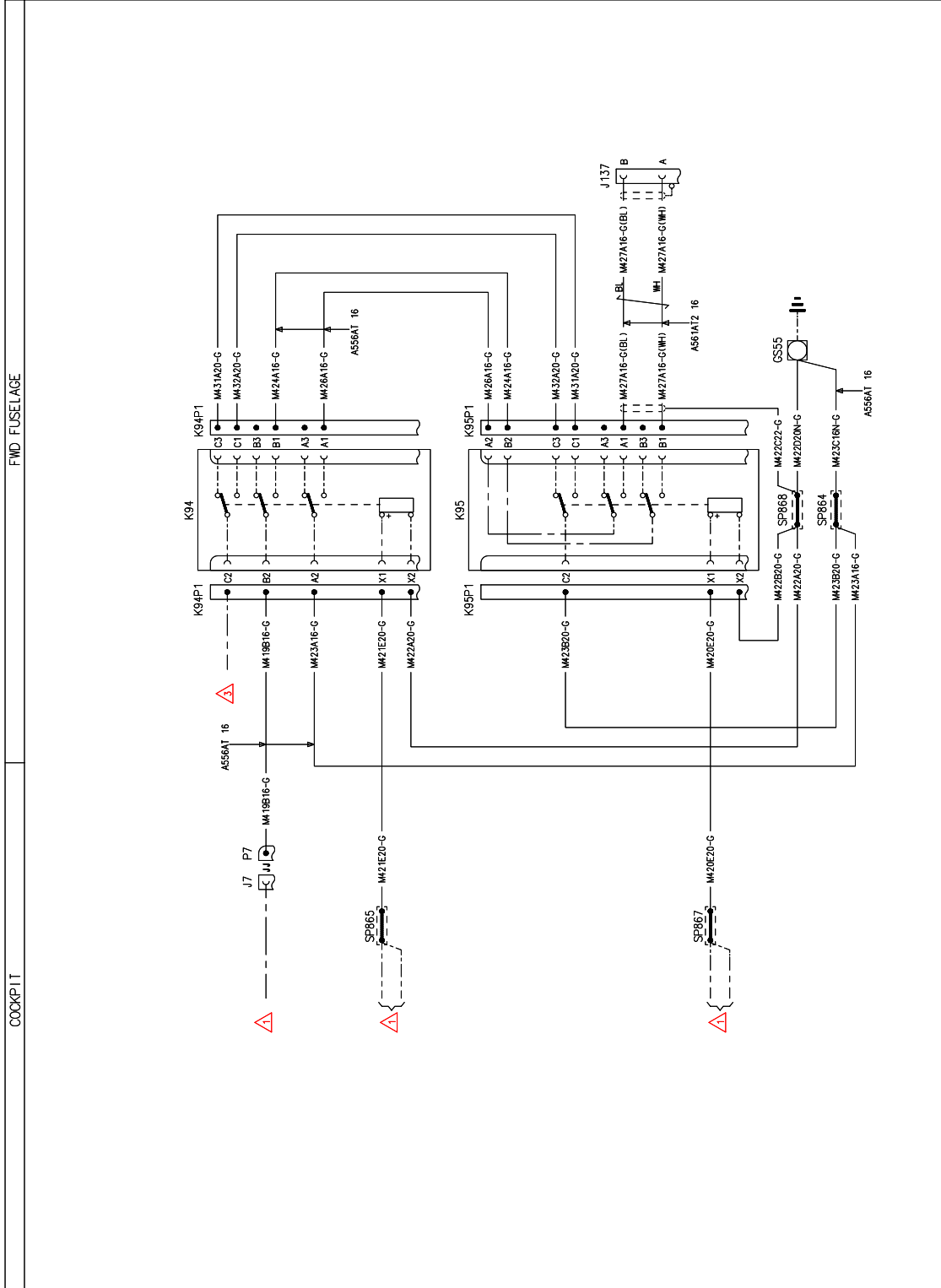

FUNCTIONAL NOTES
ALL CABLES ARE IN LOOM B1B138 UNLESS SPECIFIED
ALL CABLES ARE OF TYPE A556AT 20 UNLESS SPECIFIED

Figure 7

DRAWING REF. KEY
 SHEET NO. 2

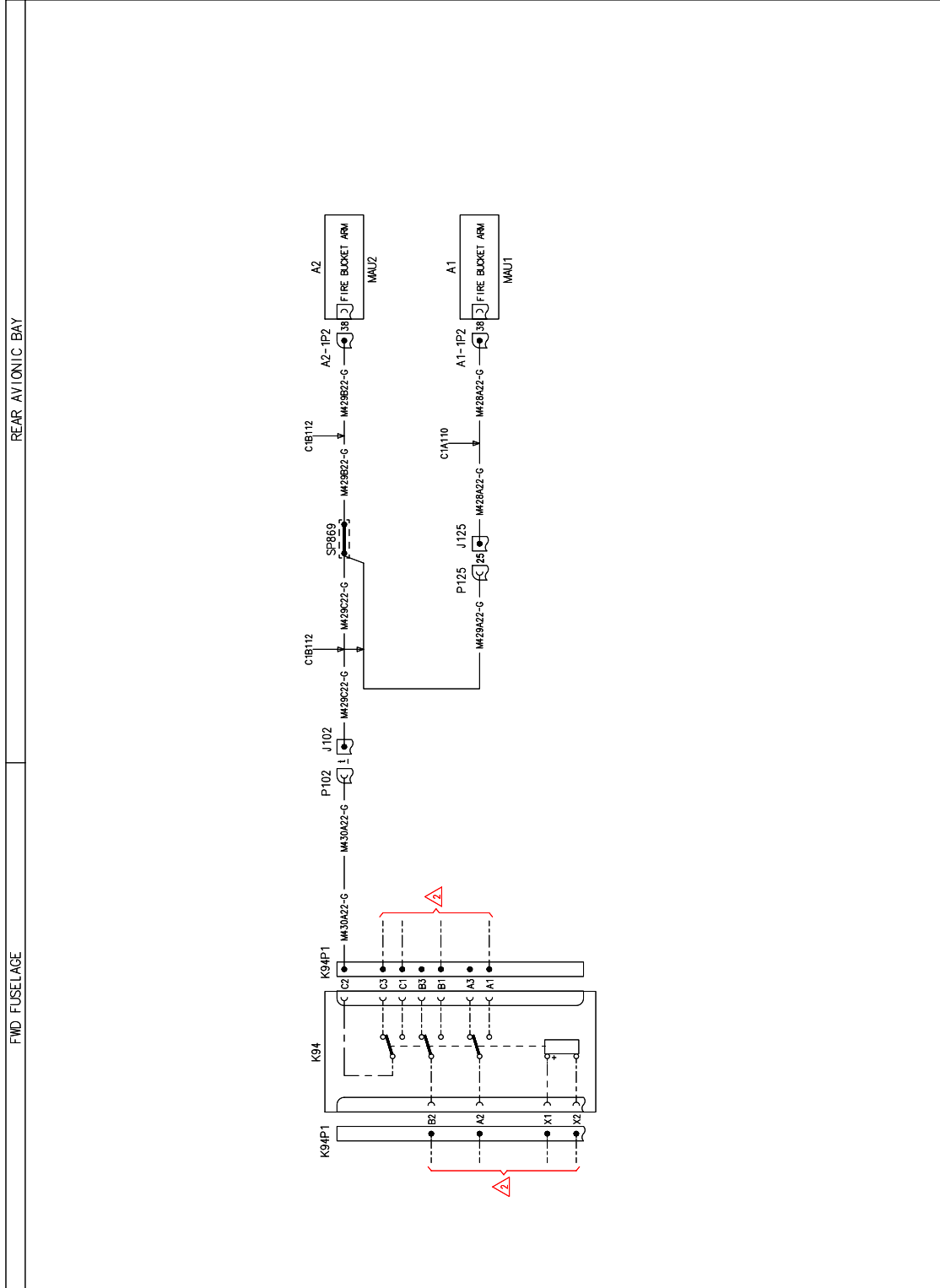

FUNCTIONAL NOTES
 ALL CABLES ARE IN LOOM B1B139 UNLESS SPECIFIED.
 ALL CABLES ARE OF TYPE ASSMAT 22 UNLESS SPECIFIED.

Figure 8

S.B. N°139-266 OPTIONAL
 DATE: October 7, 2011
 REVISION: B - June 20, 2023

4G2590F00312
KIT BAMBY BUCKET PROVISION

APPLICABLE TO HELICOPTERS:
FROM S/N 31201 TO S/N 31398
FROM S/N 41201 TO S/N 41293

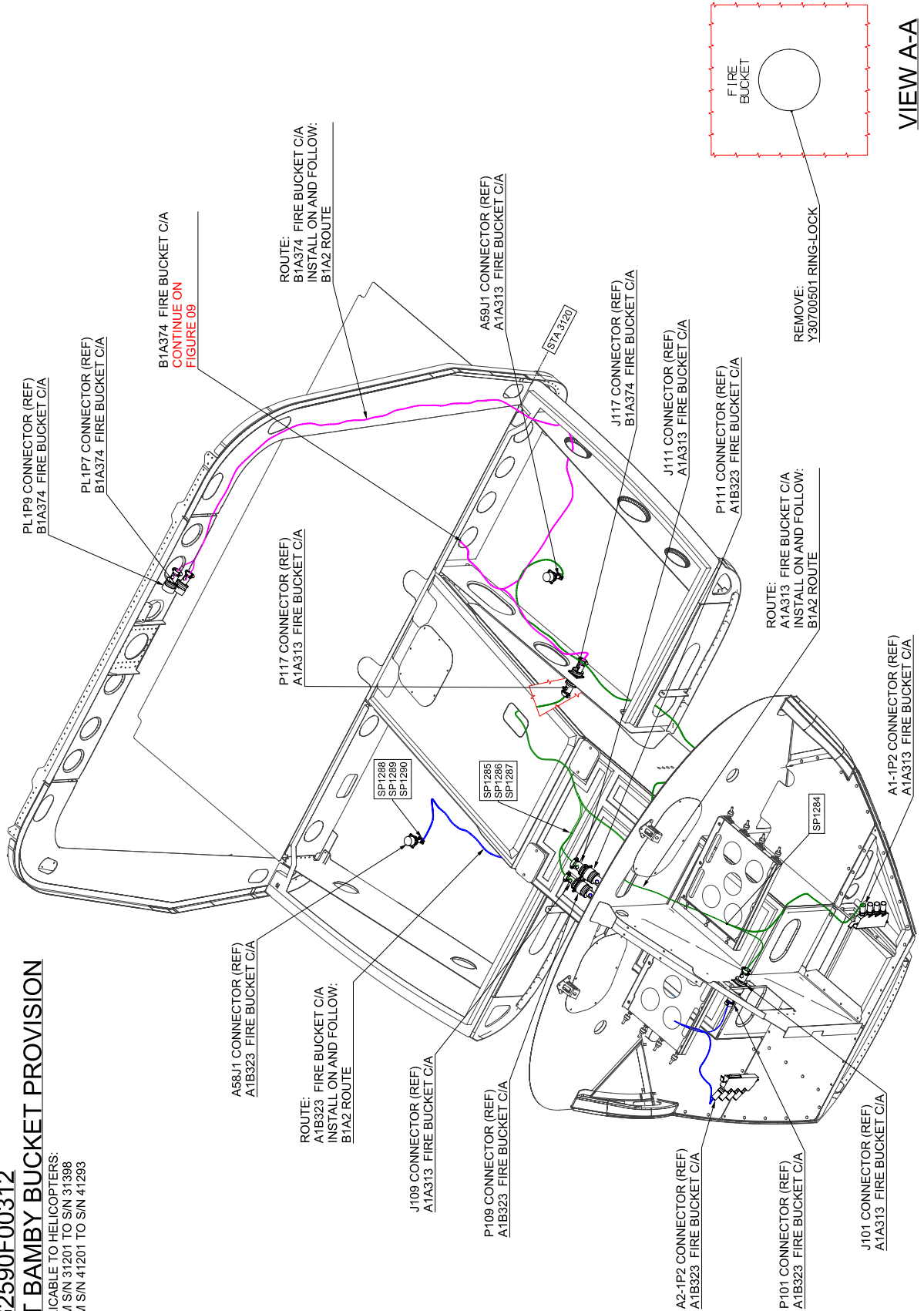

Figure 10

S.B. N°139-266 OPTIONAL
DATE: October 7, 2011
REVISION: B - June 20, 2023

DRAWING REF. KEY
 SHEET NO. 2

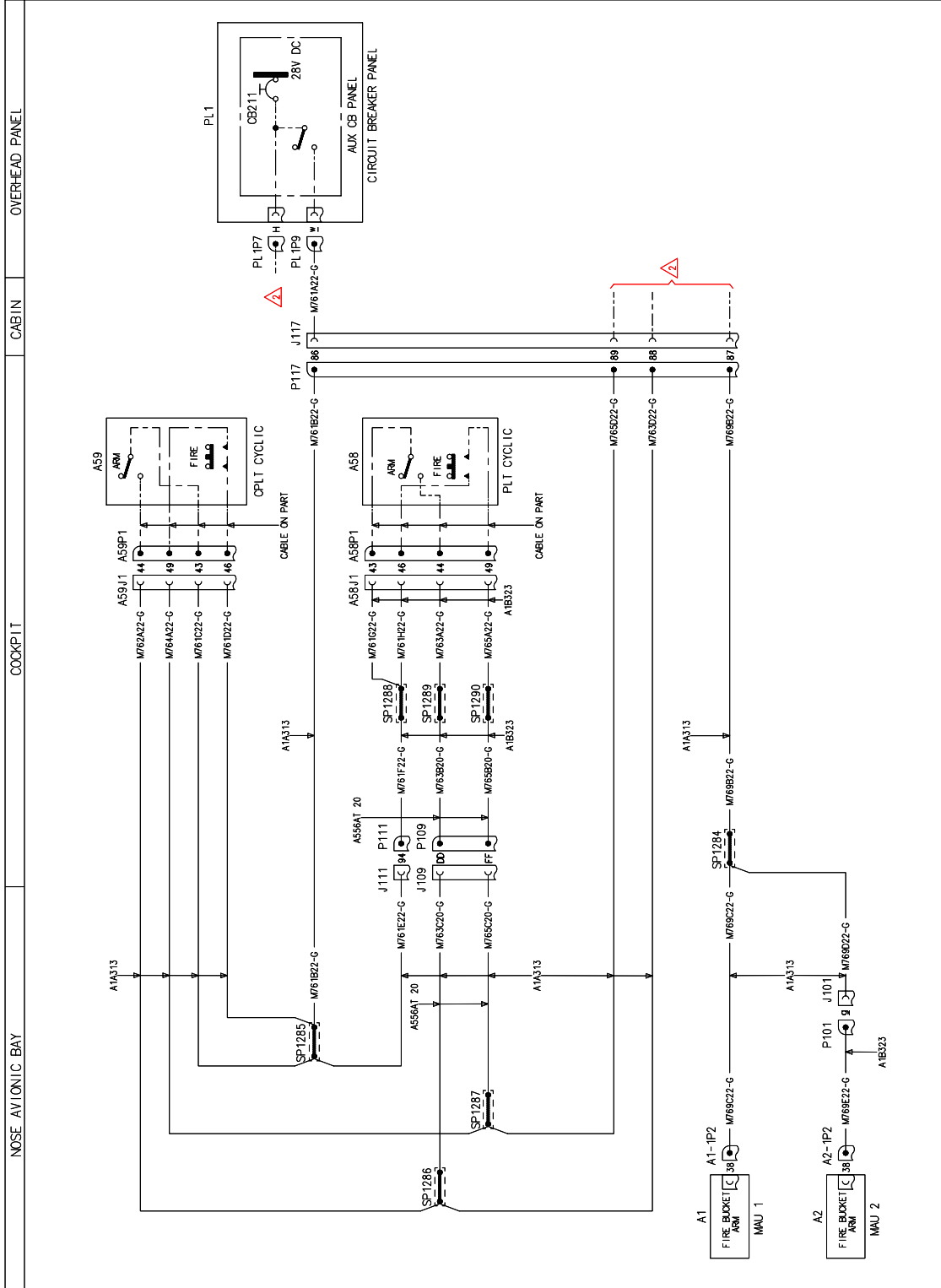

Figure 11

FUNCTIONAL NOTES

ALL CABLES ARE IN LOOM B1A374 UNLESS SPECIFIED
 ALL CABLES ARE OF TYPE A556AT 22 UNLESS SPECIFIED

DRAWING REF. KEY

△ SHEET NO. 1

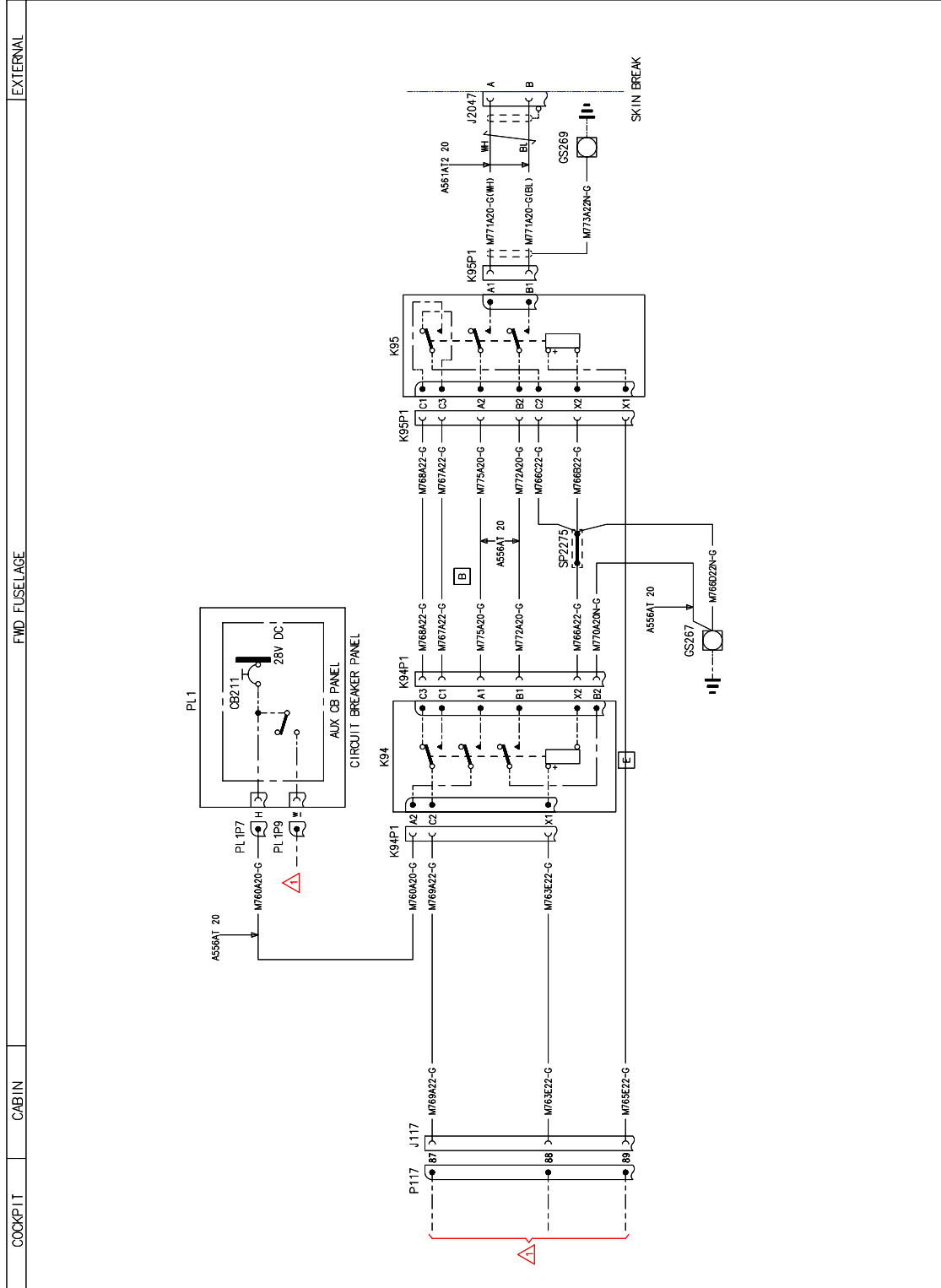

FUNCTIONAL NOTES

ALL CABLES ARE IN LOOM B1A374 UNLESS SPECIFIED
ALL CABLES ARE OF TYPE A556AT 22 UNLESS SPECIFIED

Figure 12

S.B. N°139-266 OPTIONAL
DATE: October 7, 2011
REVISION: B - June 20, 2023

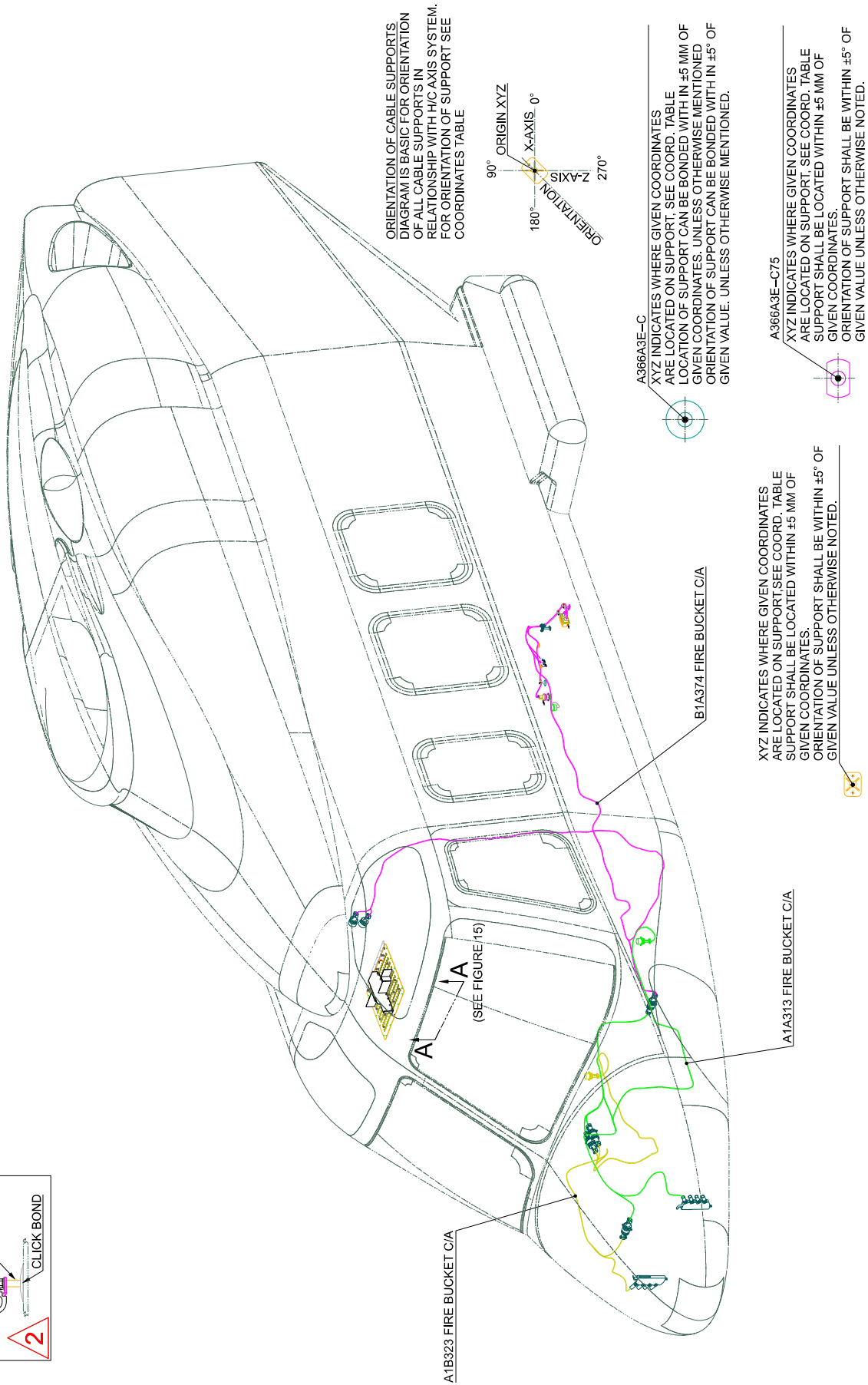
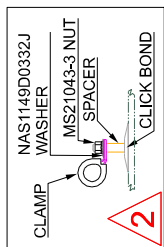
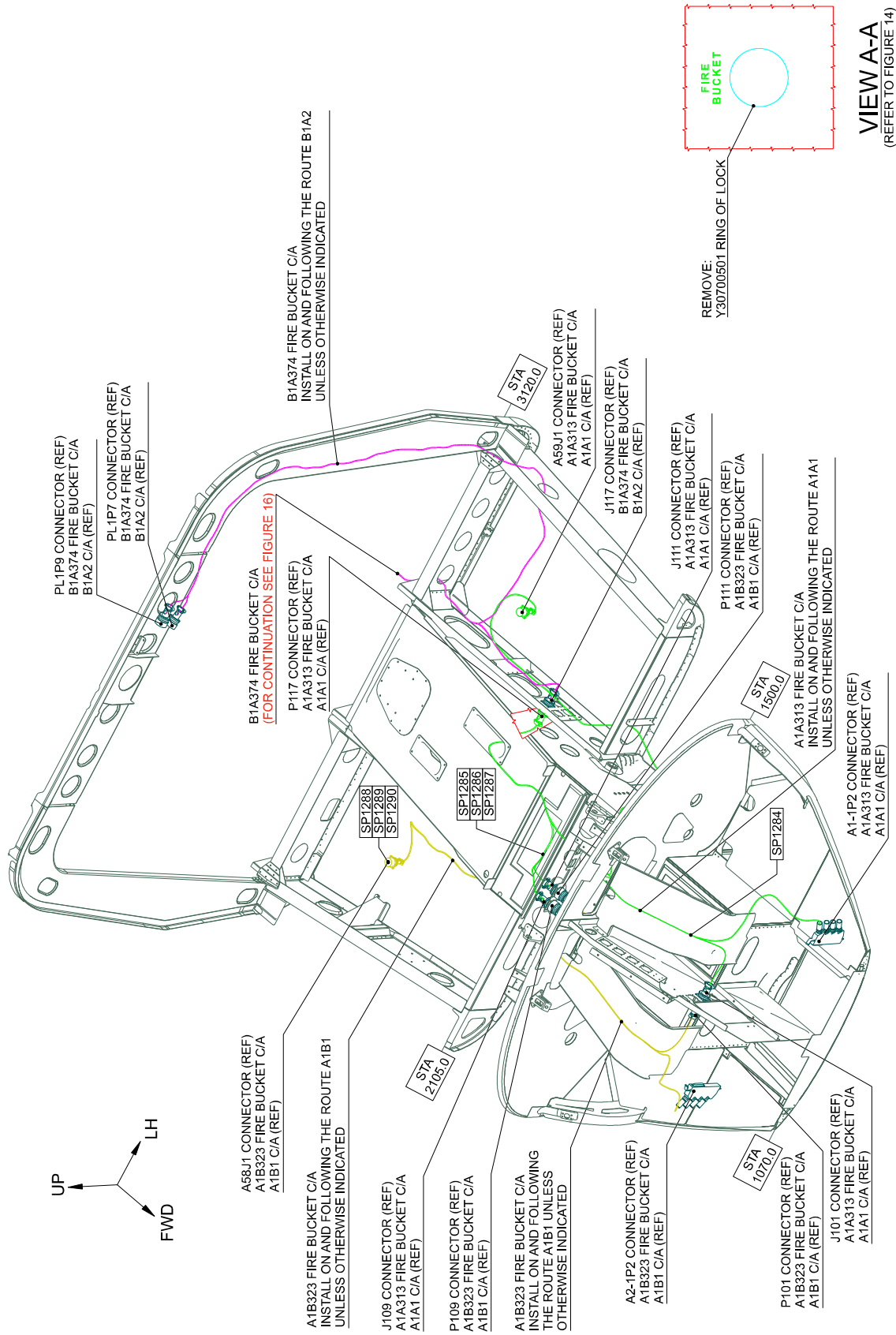

Figure 14

S.B. N°139-266 OPTIONAL
DATE: October 7, 2011
REVISION: B - June 20, 2023



VIEW LOOKING FROM STA 1070 TO STA 3120
STRUCTURE AND SYSTEMS ARE PARTIALLY OMITTED FOR BETTER CLARITY PURPOSE

Figure 15

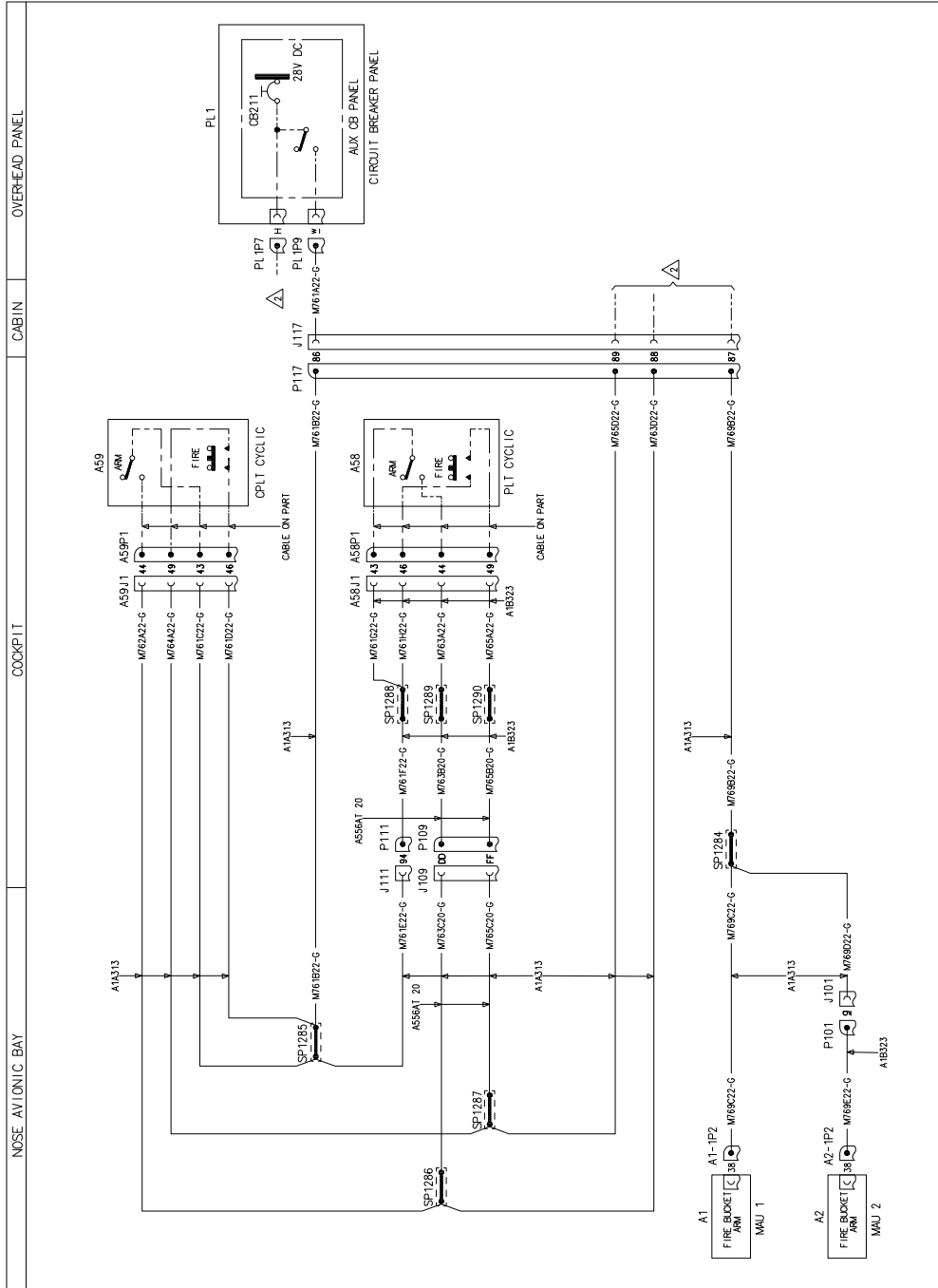

DRAWING REF. KEY

△ SHEET NO. 2

FIRE BUCKET C/A (A1A313)

| CABLE ASSY | REF-DES | PIN | CONTACT PIN | INSULATION SLEEVING |
|------------|---------|-----|--------------|---------------------|
| A1A313 | A1-1P2 | 38 | M3902N65-384 | - |
| A1A313 | J109 | DD | M3902N65-357 | - |
| A1A313 | J109 | FF | M3902N65-352 | - |
| A1A313 | P117 | 87 | M3902N65-360 | - |
| A1A313 | J101 | 9 | M3902N65-351 | - |
| A1A313 | P117 | 86 | M3902N65-360 | - |
| A1A313 | A59J1 | 43 | M3902N65-348 | - |
| A1A313 | A59J1 | 46 | M3902N65-348 | - |
| A1A313 | J111 | 94 | M3902N65-348 | - |
| A1A313 | A59J1 | 44 | M3902N65-348 | - |
| A1A313 | P117 | 88 | M3902N65-360 | - |
| A1A313 | A59J1 | 49 | M3902N65-348 | - |
| A1A313 | P117 | 89 | M3902N65-360 | - |

FIRE BUCKET C/A (A1B323)

| CABLE ASSY | REF-DES | PIN | CONTACT PIN | INSULATION SLEEVING |
|------------|---------|-----|--------------|---------------------|
| A1B323 | P101 | 9 | M3902N65-363 | - |
| A1B323 | A2-1P2 | 38 | M3902N65-354 | - |
| A1B323 | P109 | DD | M3902N65-364 | - |
| A1B323 | P111 | 94 | M3902N65-360 | - |
| A1B323 | A58J1 | 43 | M3902N65-348 | - |
| A1B323 | A58J1 | 46 | M3902N65-348 | - |
| A1B323 | A58J1 | 49 | M3902N65-348 | - |
| A1B323 | P109 | FF | M3902N65-364 | - |

FIRE BUCKET C/A (B1A374)

| CABLE ASSY | REF-DES | PIN | CONTACT PIN | INSULATION SLEEVING |
|------------|---------|-----|--------------|---------------------|
| B1A374 | J117 | 86 | M3902N65-348 | - |

3G2590W00111

WIRING DIAGRAM FIRE BUCKET

SHEET 1

FUNCTIONAL NOTES

ALL CABLES ARE IN LOOM B1A374 UNLESS SPECIFIED.
ALL CABLES ARE OF TYPE A556AT 22 UNLESS SPECIFIED

Figure 17

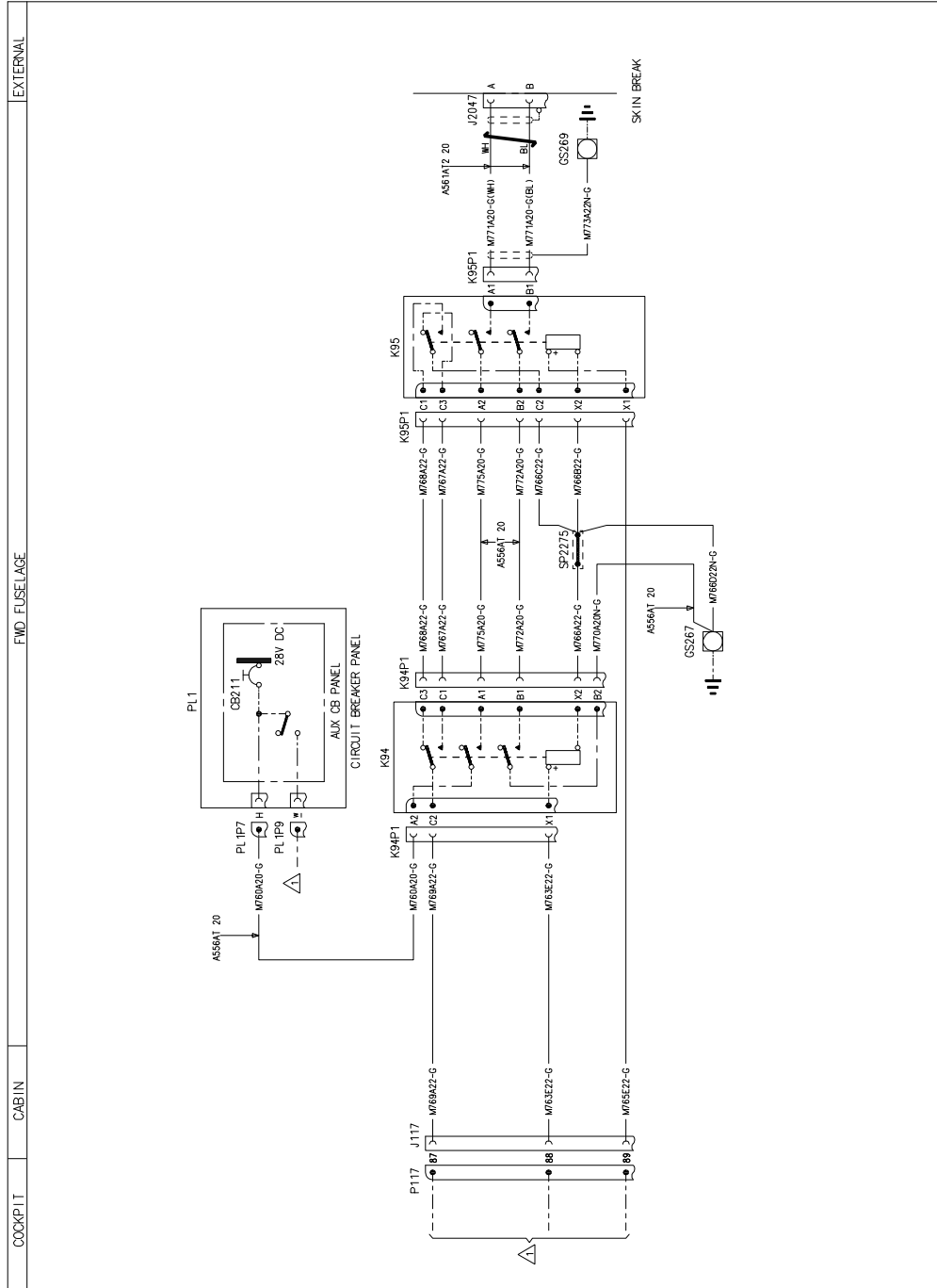

DRAWING REF. KEY
 SHEET NO. 1

FIRE BUCKET C/A (B1A374)

| CABLE ASSY | REF-DES | FIN | CONTACT FIN | INSULATION SLEEVING |
|------------|---------|-----|--------------|---------------------|
| B1A374 | GS269 | * | MS25036-103 | - |
| B1A374 | J117 | 89 | M3902956-548 | - |
| B1A374 | PL1P7 | H | M3902956-564 | - |
| B1A374 | J117 | 88 | M3902956-548 | - |
| B1A374 | J117 | 87 | M3902956-548 | - |
| B1A374 | GS267 | - | MS25036-103 | - |
| B1A374 | PL1P9 | w | M3902956-583 | - |
| B1A374 | GS267 | * | MS25036-103 | - |

Figure 18

FUNCTIONAL NOTES

ALL CABLES ARE IN LOOM B1A374 UNLESS SPECIFIED
 ALL CABLES ARE OF TYPE AS56AT 22 UNLESS SPECIFIED

